

RADIO CRAFT

TELEVISION OVER
A LIGHT BEAM

SEE PAGE 22



In this issue—

*VFO Transmitter or Exciter
Improving Midget Receivers
Moving-Coil Phono Pickup*

JUL

1947

25¢

CANADA 30¢

RADIO-ELECTRONICS IN ALL ITS PHASES

Going places
(AGAIN)

hallicrafters



Hallicrafters famous radio equipment, sold and distributed around the world before the war and used with superb effectiveness in every theater during the war is once again on the move. Watch for latest details of the Gatti-Hallicrafters mobile radio equipped expedition to the Mountains of the Moon in deepest Africa—a new and exciting test for the ingenuity of hams and the performance of Hallicrafters equipment.

3

GREAT RECEIVERS designed and priced for hams who are going places, too



Model SX-42 Described by hams who have operated it as "the first real postwar receiver." One of the finest CW receivers yet developed. Greatest continuous frequency coverage of any communications receiver—from 540 kc to 110 Mc, in six bands. FM-AM-CW. 15 tubes. Matching speakers available. **\$275⁰⁰**



Model S-40A Function, beauty, unusual radio performance and reasonable price are all combined in this fine receiver. Overall frequency range from 540 kc to 43 Mc, in four bands. Nine tubes. Built-in dynamic speaker. Many circuit refinements never before available in medium price class. **\$89⁵⁰**



Model S-38 Overall frequency range from 540 kc to 32 Mc, in four bands. Self contained speaker. Compact and rugged, high performance at a low price. Makes an ideal standby receiver for hams. CW pitch control is adjustable from front panel. Automatic noise limiter. **\$47⁵⁰**

Prices slightly higher in zone 2

BUILDERS OF *Skyfone* AVIATION RADIOTELEPHONE



hallicrafters RADIO

THE HALLICTRAFTERS CO., MANUFACTURERS OF RADIO AND ELECTRONIC EQUIPMENT, CHICAGO 16, U. S. A.
Sole Hallicrafters Representatives in Canada: Rogers Majestic Limited, Toronto-Montreal

**I WILL SEND YOU
BOTH FREE**

NEW 64 PAGE BOOK

64-page illustrated book describes many fascinating jobs Radio, Television, Electronics offer, shows big kits of Radio parts I send you, tells how I give you practical experience building real Radio circuits at home in spare time, how you make extra money fixing Radios while still learning; contains letters from many men I trained, telling what they are doing, earning. FREE. Mail Coupon below!

SAMPLE RADIO LESSON

I will also send you my Lesson, "Getting Acquainted With Receiver Servicing," FREE, to show you how practical it is to learn Radio at home in spare time. It's a valuable Lesson. Study it—keep it—use it—without obligation! Tells how "Superhet" Circuits work, gives hints on Receiver Servicing, Locating Defects, Repair of Loudspeaker, I.F. Transformer, etc. 31 illustrations. Mail Coupon below!



SEE FOR YOURSELF HOW I TRAIN YOU AT HOME TO BE A RADIO TECHNICIAN

Do you want a good-pay job in Radio—or your own money-making Radio Shop? Mail Coupon for a FREE Sample Lesson and my FREE 64-page book, "How to Be a Success in RADIO—Television, Electronics." See how N.R.I. gives you practical Radio experience at home—building, testing, repairing Radios with BIG KITS OF PARTS I SEND!

Many Beginners Soon Make Good Extra Money in Spare Time While Learning

The day you enroll I start sending EXTRA MONEY JOB SHEETS. You LEARN Radio principles from my easy-to-grasp, illustrated lessons—PRACTICE what you learn with parts I send—USE your knowledge to make EXTRA money fixing neighbors' Radios in spare time while still learning! From here it's a short step to your own full-time Radio Shop or a good Radio job!

Future for Trained Men is Bright in Radio, Television, Electronics

It's probably easier to get started in Radio now than ever before because the Radio Repair business is booming. Trained Radio Technicians also find profitable opportunities in Police, Aviation, Marine Radio, Broadcasting, Radio Manufacturing, Public Address work. Think of even greater opportunities as Television and Electronics become available to the public. Send for free books now!

Find Out What N.R.I. Can Do for You

Mail Coupon for Sample Lesson and my 64-page book. Read the details about my Course. Read letters from men I trained, telling what they are doing, earning. See how quickly, easily you can get started. No obligation! Just MAIL COUPON NOW in an envelope or paste it on a penny postal. J. E. SMITH, President, Dept. 7GX, National Radio Institute, Pioneer Home Study Radio School, Washington 9, D. C. Our 33rd Year of Training Men for Success in Radio

VETERANS

You can get this training right in your own home under G. I. Bill. Mail coupon.

I TRAINED THESE MEN

Averages Better Than \$3,000 A Year

"I now have a shop and am doing fine. I average better than \$3,000 per year, and certainly give NRI much of the credit."—RAYMOND F. DAVIS, Ashburn, Georgia.



Made \$612 In 12 Mos. Spare Time

"Soon after I finished my experimental kits lessons I tackled my first Radio service job. The neighbors were very cooperative. I soon had all the repair jobs I could handle in spare time. I have made \$612 in the past 12 months in spare time."—J. W. CLARK, Wilmington, North Carolina.

Build Radio Circuits Like These With Kits I Send

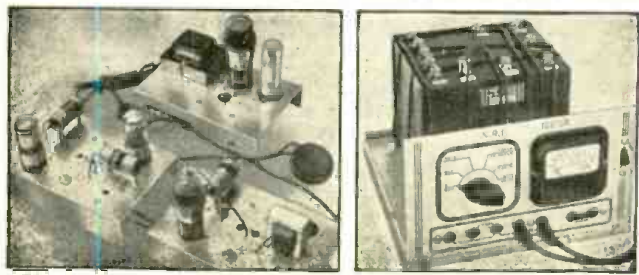

Good for Both FREE

MR. J. E. SMITH, President, Dept. 7GX, National Radio Institute, Washington 9, D. C. Mail me FREE, without obligation, Sample Lesson and 64-page book about how to win success in Radio—and Television, Electronics. (No salesman will call. Please write plainly.)

Age.....
Name.....
Address.....
City..... State.....
(Please include Post Office zone number)

Approved for Training under GI Bill

SYLVANIA NEWS

RADIO SERVICE EDITION

JULY

Prepared by SYLVANIA ELECTRIC PRODUCTS INC., Emporium, Pa.

1947

RADIO SERVICEMEN! GET EXTRA SERVICE SALES WITH NEW PROMOTIONAL CAMPAIGN!

Powerful Advertising Drives Opening Wedge...
Effective Mail Pieces Help Clinch Sales!



Advertisements in such national magazines as Collier's, the Saturday Evening Post and Life are examples of Sylvania's tremendous campaign which tells millions of people about your radio service. This hard-selling campaign naturally helps to bring customers into your store.

These inexpensive, attention-getting mailing pieces remind *your* customers to bring their "Radio Service" work to *your* store... remind them, too, that you carry the finest line of radio tubes made.

Month after month, Sylvania's nationwide advertising pounds home the same message to your customers.

Month after month it tells them the advantages of having their radios serviced by competent radio servicemen. You'll find that you'll get the best results from this selling effort by supplementing it with your choice of the sales aids illustrated above... which clinch the sale by directing customers to your store.

ORDER FROM YOUR SYLVANIA DISTRIBUTOR or write SYLVANIA ELECTRIC PRODUCTS INC., EMPORIUM, PA.

SYLVANIA ELECTRIC

MAKERS OF RADIO TUBES, CATHODE RAY TUBES, ELECTRONIC DEVICES, FLUORESCENT LAMPS, FIXTURES, WIRING DEVICES, ELECTRIC LIGHT BULBS

Free to Servicemen...

this great source
of money-making ideas



Mail coupon below—
your subscription
will start at once

Meet "The Capacitor"—the magazine that's published by Cornell-Dubilier solely to help servicemen speed up their work—build up their business.

It has no frills—it isn't cluttered up with complicated mathematics—and you could read it for years without learning how to build a crystal set. Instead its articles are meaty, down-to-earth—practical discussions of the problems every serviceman meets every day. Never before has there been such a great demand for helpful servicing ideas—and "The Capacitor" is C-D's answer to this demand.

Use "The Capacitor" to help build up *your* service business—as it has for thousands of other successful servicemen. Don't wait—mail coupon NOW and your FREE subscription will start immediately.

THE TRADING POST—Looking for a new 'scope at a bargain price? Need a helper? Have you anything to sell? If so, write up an ad and send it in to "The Trading Post"—the serviceman's clearing house—which appears every month in "The Capacitor." This feature alone may make "The Capacitor" worth many dollars to you.

LATEST FM CIRCUITS—"It works all right on AM but when I try to use FM all I get is a lot of noise." You'll be hearing that story more and more as the new FM jobs come on the market. Get set for them now by keeping up with the new FM circuits as they appear in "The Capacitor."

"THE CAPACITOR IS EXCELLENT"—"I received my first copy of 'The Capacitor' the other day and I want to tell you that I think it is excellent. The articles are very interesting and clearly written. You have my congratulations on a very fine magazine." Culled from the hundreds of letters received every week.

1930



1947

CORNELL-DUBILIER
WORLD'S LARGEST MANUFACTURER OF
CAPACITORS

MICA • DYKANOL
PAPER • ELECTROLYTIC

CLIP COUPON—MAIL NOW

Cornell-Dubilier Electric Corporation Dept. RC7
South Plainfield, New Jersey

Please start my FREE subscription to "The Capacitor"
at once.

Name.....

Address.....

City..... Zone..... State.....

Start your own RADIO SERVICE SHOP

Choose one of these
3 GREAT NEW DEALS

\$99⁵⁰

\$179⁵⁰

\$350⁰⁰

Includes TEST EQUIPMENT, TUBES, PARTS, TOOLS

3 complete going-in-business packages. (If necessary they can be changed to suit your needs.)

There never was a better opportunity than now to start a profitable business of your own. No fuss, no worry. Here's everything you need. Details upon request. Write, wire or phone!

Featherweight Miniature TEST INSTRUMENTS

Compact — Accurate — Priced Right!

- Jeweled Motor • Range Selector Switch
- All multipliers bridge tested for 1% accuracy
- Zero adjustment—built in batteries
- Molded bakelite case only 3.13/16" x 2-7/8" x 2"

MODEL 451A AC-DC Volt—Ohm— Milliammeter



A dependable instrument of wide utility—sensitivity 1000 ohms per volt. Ranges: Volts AC, DC, and Output Ranges, 0-10/50/100/500/1000; Ohms full scale, 500,000. Ohms center scale, 7200.

NET complete with batteries..... **1490**

MODEL 312 Volt—Ohm— Milliammeter



An economy pocket meter featuring a 2" moving vane meter. Reads: AC-DC volts, 0-25/50/125/250; Mills AC-DC, 0-50; Ohms, 100,000; mfd. .05-15. Jacks provide range selection.

NET Complete with cord and plug..... **675**

FAMOUS "LITTLE TRIPLETTS"

The Little Testers with the big 3" Meters Bakelite cases 3 1/4" x 5 3/4" x 2 1/4" Range selection switch—long, easy to read scales. We made a good buy—here they are at rock-bottom prices—The greatest buy ever offered in precision testing equipment.

Model 650SC - OUTPUT METER

A 4000 ohm constant impedance AC volt meter with ranges of 0-1.5-6-15-60-150 volts. Conversion chart for reading DB level from -10DB to +35 DB. 100 microampere meter. Excellent for receiver alignment, level indicators in recording equipment, general use on electronic apparatus. Regular net 24.50. A "one time only" Special buy at..... **1049**



Model 606B-VOLTAGE TESTER

Checks voltage and polarity. Range: 0-440 AC-DC volts—definite indications for 115, 220, and 440 volt lines. Separate polarized vane for AC or DC indication. Built in test leads. Excellent for checking wiring, fuses, general factory installation and maintenance. Every plant — every electrician needs several at this low price. Regular net 16.67 Special at..... **895**



RADIANT AERIALS

The Quality leader • Recognized by everyone • Admirably brass rods • Triple plated • Permanently rattle proof • Static muffler ball • Polyethylene insulated HI Q lead with protective vinylite covering • Supplied with single pin (Motorola) connector and adaptor for bayonet style (Deico and Philco) fittings.



TYPE CF3-63

A two insulator side cowl mount—3 section 63" rod—supplied with 3 insulators and wedge adaptor to fit 95% of all car bodies—complete with 48" lead. **199**
List price \$4.95—our price.....



TYPE CFA3-63

All angle cowl or fender mount—A modern Radiant development—fits all body contours, straight or curved, cowl or fender. 3 section 63" rod easily adjusted to vertical without tools—complete with 40" lead. **199**
List price \$5.45 we sell for.....

GENERATOR CONDENSERS



PHILCO part No. 61-0177—5 mfd.—5/8" x 1 1/4"—4" lead-slotted mounting strap for easy installation—Standard Merchandise—not war surplus—Present list price \$1.00. Our special—over 85% off..... **14c**

200 WATT SOLDERING IRON FAMOUS HEXACON ELECTRIC'S MODEL 201



FEATURES: Full 200 watt replaceable element. 5/8" tinned Copper tip, replaceable. One piece drawn case-gun metal finish. 6' heavy duty cord—stand included. Comfortable, well balanced handle. Operates on 110 volts—AC or DC. List Price \$8.00 Speed up your heavy work—Save time—save money at..... **369**

OUTPUT TRANSFORMERS

Clean stocks — long leads — mounting feet — made to fit where you need them. For 6F6-6K6—to 4 ohm voice coil—size 2" x 1 1/4" x 1 3/4". 50L6-35L6-25L6 to 4 ohm voice coil 1 1/2" x 1 1/2" x 1 3/4". Specify quantity of each type you need at..... **49c**



Order from the Ad
Write - Wire - Phone

PHONO PICKUP CRYSTALS

Standard types—Set Manufacturers dose-out—All Guaranteed



Webster F2—Replaces L26-L40-L70 etc.—pin type terminals—1 oz. pressure—1 volt output—5000 cycle cutoff. List price \$5.00—you pay us..... **149**



SHURE P93—W57A—pin type terminals—3/4 oz. pressure—1.6 volt output—6000 cycle cut off. List price \$4.45—our Special..... **198**



Astatic L-70—new post war design—solder terminals—1 1/4 oz. pressure—1 volt output—4000 cycle cutoff. List price \$5.55—we quote you... **198**

PHILCO BEAM OF LIGHT

Selenium cell only, no holder, postpaid... (Puts new life into Philco Changers) **180**
Sapphire needle only, no mirror, postpaid..... **120**

ALL RUBBER LAMP CORD



Underwriters Approved brown rubber covered insulated parallel Cord—"zips" apart easily—non fraying—deluxe—way above average quality. 500' Roll..... **989**

MULTI-USE WIRE



Stranded No. 22 tinned wire—glass "ROCKBESTOS" 1000 volt insulation—greproof aircraft wire—a war-time development—at this low price you can use the best—

100 feet..... **45c** 1000 feet..... **389**

JEWELLED PILOT LIGHT ASSEMBLIES



- Candelabra screw base for 110 volt lamp.
- Mount in 1" hole.
- Lamps removable from front of panel.
- Available marked 1-2-3 or 4 on back of white lens.

YOUR CHOICE net..... **19c**

Include full remittance with orders of \$3.00 or less. Include 25% deposit with all C.O.D. orders of \$3.00 or more. Prices subject to change without notice.

SEND FOR FREE CATALOG

RADIO SUPPLY & ENGINEERING CO., Inc.

125 SELDEN AVE.

DETROIT 1, MICH.

NO OTHER SERVICE GIVES YOU THESE EXCLUSIVE PHOTOFACT* ADVANTAGES

PHOTOFACT FOLDERS are based on OUR actual study of the equipment covered. We **ORIGINATE** information — we do not copy it! Every fact is quadruple-checked for accuracy. **NO OTHER SERVICE COMPARES WITH PHOTOFACT.**



PHOTOFACT VOLUMES I and II

The first 20 Sets of PHOTOFACT Folders are now available in Two Volumes—Think of it! Almost 3800 pages, covering approximately 1800 NEW 1946 & 1947 Models and Chassis designations—Yours for only \$18.39 each. If you prefer drawer filing, order any or all of the 20 individual sets of folders @ \$1.50 per set—Less than two cents a model.

HOWARD W. SAMS & CO., INC.
Indianapolis 6, Indiana
My (check) (Money order) is enclosed.
Send Vol. I () Vol. II ()
Set No. ()

Name _____

Address _____

City _____

State _____

PHOTOGRAPHS
Top-Bottom and Other Views
of Every Instrument
Large, Clear with
Each Part Coded

CODED SCHEMATICS
For EVERY Receiver
Keyed to Complete
Parts List

DIAL CORD DATA
For EVERY Receiver
PRODUCTION CHANGES
The Only Service That
is Always Up-To-Date

MOST ACCURATE!
Based On Study of
The Actual Equipment
MOST COMPLETE!
Gives You All
The Data You Need
MOST UNIFORM!
Data is Always in The
Same Place
Easiest to Use

COMPARE BEFORE YOU BUY

Ask to see PHOTOFACT VOLUMES I and II the next time you visit your parts distributor. Look through the books. Notice these Points: The same complete data always in the same easy-to-find-location! The schematic and pictorial diagrams for every Post War set—**BIG, CLEAR, ACCURATE PICTURES**—Each with its simple coding system keyed for instant reference to

complete parts lists for every instrument! The full alignment and circuit data! The disassembly instructions! The Dial Cord Drawings. And, even **RECORD CHANGERS** are completely diagrammed.

Now put any other service beside PHOTOFACT and compare—That's all we ask. Use PHOTOFACTS once—You'll use them forever.

YOU'LL WANT PHOTOFACT

Individual PHOTOFACT Folder Set #20 available June 15 at the same low cost of \$1.50. Order PHOTOFACT Volumes I

and II or the individual sets of Folders from your distributor, OR directly from us.

ASK THE MAN THAT USES PHOTOFACTS

*Reg. U. S. Pat. Off.

HOWARD W. SAMS & CO., INC.

INDIANAPOLIS 6, INDIANA

Export — Ad. Auriema — 89 Broad St., New York 4, N. Y. — U. S. of America
Canada — A. C. Simmonds & Sons, 301 King St. East — Toronto, Ontario

PHOTOFACT SERVICE

"The Service that pays for itself over and over again"

SILVER

"906"

AM-FM SIGNAL GENERATOR

90KC—170MC-AM

90KC—210MC-FM

89.90
NET

A SIGNAL GENERATOR OF LABORATORY CALIBER

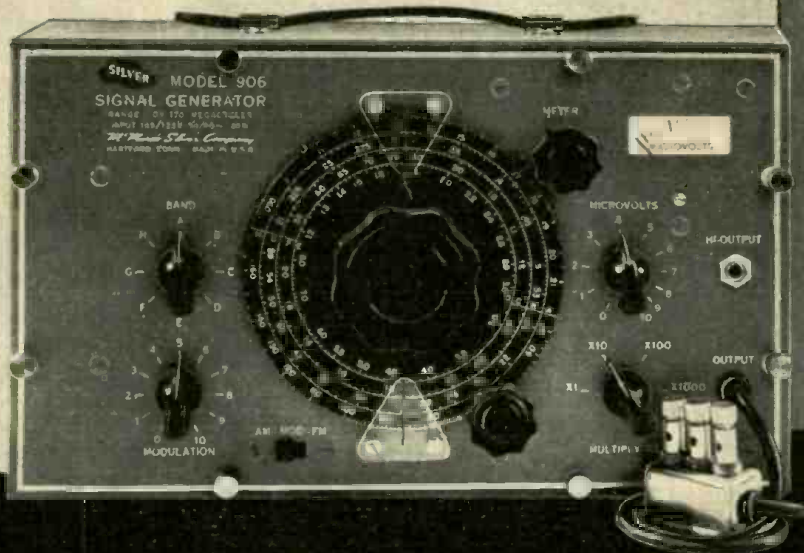

MODEL "906" Signal Generator carries to new heights the SILVER tradition for the finest in test equipment at prices so low as to be impossible to any other manufacturer.

Eight fundamental ranges, direct frequency calibrated to $\pm 1\%$ accuracy, cover 90 kc. through 170 mc. A three tube R C a.f. oscillator provides 400 cycles AM modulation, panel variable from 0 to nearly 100%. Panel switch shifts to FM, 90 kc. through 210 mc., with MODULATION knob setting built-in electronic FM sweep anywhere from 0 to 500 kc.

Output is continuously variable from less than 1 microvolt, including strays through 20 mc., to

over 1 volt. Microvolt meter, dual variable and 4-position ladder attenuators; complete multiple shielding, 4-section line filter, all add up to a signal generator utterly without equal today.

Add size and style matching famous "VOMAX", "SPARX" Dynamic Signal Tracer and MODEL 904 Condenser Resistor Tester and you have unmatched value. Yet volume production, carefully controlled SILVER manufacturing costs, bring you MODEL "906" at only \$89.90 net.

Better get yours now, for production can't catch up with demand upon this truly superb laboratory instrument for months to come.

Mail postcard for NEW 16-page catalog just released.

OVER 36 YEARS OF RADIO ENGINEERING ACHIEVEMENT

McMurdo Silver Co., Inc.

1249 MAIN STREET • HARTFORD 3 • CONNECTICUT

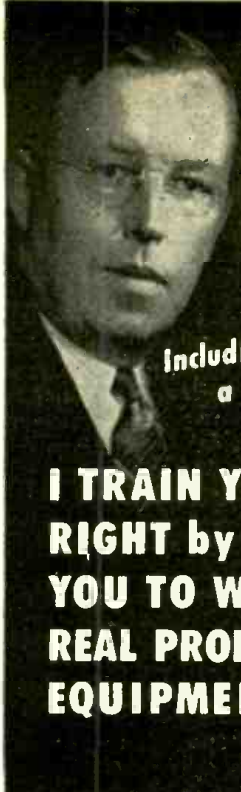

NOW! An Amazing Opportunity to LEARN RADIO AT HOME

I SEND YOU 8 BIG KITS OF RADIO PARTS

Including a **COMPLETE 6 TUBE SUPER-HETERODYNE RECEIVER**

I TRAIN YOU RIGHT by PUTTING YOU TO WORK with REAL PROFESSIONAL EQUIPMENT!

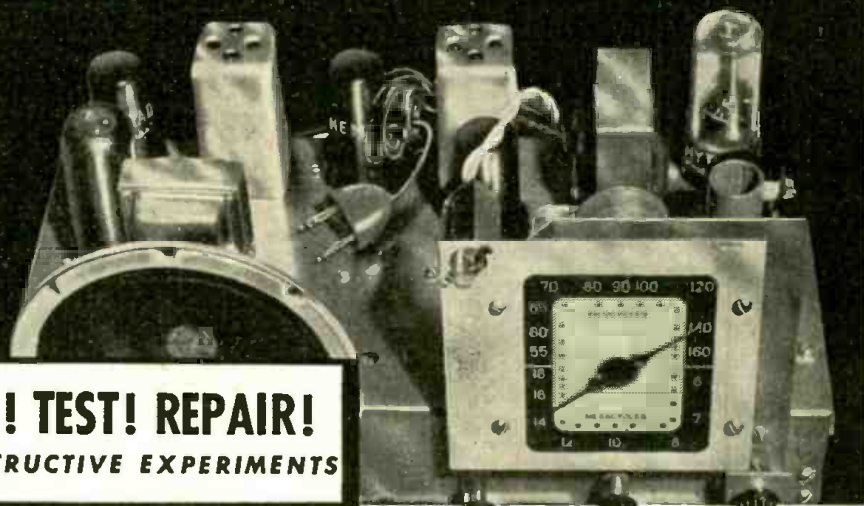

LEARN HOW TO BUILD CIRCUITS! TEST! REPAIR!
YOU DO OVER 175 INSTRUCTIVE EXPERIMENTS



HERE'S THE EASIEST, MOST PRACTICAL WAY OF ALL TO PREPARE FOR GOOD PAY in RADIO ELECTRONICS and TELEVISION!

I train your mind by putting you to work with your hands on a big 6-Tube Superheterodyne Receiver. And, believe me, when you get busy with real Radio Parts — 8 big Kits of them — you really LEARN Radio and learn it RIGHT! You get the practical stuff you need to be useful in Radio, and that's what it takes to make money. You don't have to worry about what to do with these 8 Kits of Parts. Step by step, I show you how to build circuits, test, experiment, trouble-shoot. And you don't need any previous experience. The Sprayberry Course starts right at the beginning of Radio! You can't get lost! Simplified lessons, coupled with real "Shop" practice, makes every subject plain and easy to understand and remember. Soon after you begin Sprayberry Training, I'll send you my sensational BUSINESS BUILDERS.

A BUSINESS OF YOUR OWN . . . OR A GOOD RADIO JOB
You'll find out how to get and do neighborhood Radio repair jobs for nice profits and rich experience while learning. This sort of work can easily pave the way for a Radio Service business of your own. But with Sprayberry Training, you're not limited. You can swing into any one of the swiftly expanding branches of Radio-Electronics INCLUDING Radio, Television, FM, Radar, Industrial Electronics. Be wise! Decide now to become a fully qualified RADIO - ELECTRONICIAN. Get full details about my Training at once! Mail coupon below for my 2 big FREE Books.

YOU BUILD THIS USEFUL TEST EQUIPMENT!



I give you a fine, moving-coil type Meter Instrument on Jewel Bearings — with parts for a complete Analyzer Circuit Continuity Tester. You learn how to check and correct Receiver defects with professional accuracy and speed.

Soldering, wiring, connecting Radio parts . . . building circuits — you can't beat this method of learning. When you construct this Rectifier and Filter, Resistor and Condenser Tester, etc., you get a really practical slant on Radio.

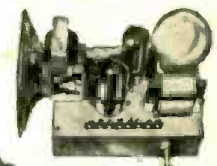

You'll get valuable experience and practice building this Signal Generator and multi-purpose Tester. Makes a breeze out of fixing Radios and you don't have to spend money on outside, ready-made equipment.



RUSH COUPON!

SPRAYBERRY ACADEMY OF RADIO
F. L. Sprayberry, President, Room 2077, Pueblo, Colorado
Please rush my FREE copies of "How to MAKE MONEY in RADIO, ELECTRONICS and TELEVISION," and "HOW to READ RADIO DIAGRAMS and SYMBOLS."

Name Age

Address

City State

(Mail in envelope or paste on penny postcard)

GET THESE VALUABLE FREE BOOKS

"How to Read Radio Diagrams and Symbols"

Here's a valuable and wonderfully complete new book which explains in simple English how to read and understand any Radio Set Diagram. Includes translation of all Radio symbols. Send for this volume at once. It's free! Along with it, I will send you another Big Free book describing in detail my Radio-Electronic Training.

Belltone
TRUE FM

TELEVISION **KIT**

**EVERYTHING
COMPLETE** and
Ready to Assemble

\$159.50

including complete
**DIAGRAMS AND
INSTRUCTIONS**
large and easy to follow
**CHASSIS AND FRONT
PANEL INCLUDED**

**26 SQ. INCH PICTURE!
6 CHANNELS!
17 TUBES!..**

including 7" Dumont Cathode
Ray Picture Tube
OPERATES ON 110 VOLTS
50-60 CYCLE
SINGLE PHASE A.C.



MODEL 500-T

Here is the finest TELEVISION kit ever offered at ANY price . . . yet THIS price is LOW . . . and you'll see HOW LOW when you examine the many HIGH-QUALITY features. It's TRUE FM sound, with exceptionally brilliant vision. The kit can easily be constructed by ANYONE who can follow a radio circuit diagram. Hundreds have already been assembled by radio students and are in continuous operation. No holes to drill. Completely punched and drilled 17" x 15" x 4" chassis and front panel supplied. This is a wonderful opportunity for you to own a GOOD television receiver. The sooner you send your order, the sooner you can begin enjoying Belltone television reception.

CHECK THIS LIST OF QUALITY FEATURES

- ★ 3.5 MC bandwidth giving beautiful picture definition.
- ★ 25.75 MC trap-tuned, high gain video I.F. transformers.
- ★ Exclusive TRUE FM sound circuit. We DO NOT use slope detection.
- ★ 3 stages of video I.F. amplification. 2 stages of video amplification.
- ★ Extremely stable hold circuits.
- ★ Includes 17 tubes (counting 7" Dumont cathode ray tube.)

USE THIS ORDER COUPON ▶

F. O. B. New York City

BELLTONE RADIO & TELEVISION CORP.
583 Avenue of the Americas, New York 11, N. Y.

BELLTONE RADIO & TELEVISION CORP. 583 Ave. of the Americas, New York 11

Please send..... BELLTONE TELEVISION KITS @ \$159.50 ea.

Check or Money Order enclosed.

NAME

STREET

CITY

STATE

RCJLY

RADIO-CRAFT for JULY, 1947

CHICAGO
ILLINOIS

DE FOREST'S TRAINING, INC.

AFFILIATED WITH DE VRY MOTION PICTURE COMPANY, CHICAGO



Step Out in Front in RADIO-ELECTRONICS ...LET US SHOW YOU HOW!

VETERANS!

Distinguish yourself as a leader. Get the real money, the better opportunities which go with leadership and initiative. Let us show you how you may find all of these things in the opportunity-packed fields of Radio and Electronics. Begin your training today so you will be prepared for leadership and opportunity tomorrow — either on a payroll or in a profitable business of your own.

Whether you are an ex-G.I., a teen-age youth or an older man, there can be a place for you in these fascinating fields.

Mail coupon below right now for late facts about the exciting events in F.M. Radio, Broadcast Radio, Motion Picture Sound, Electronics, Sound Recording, the future developments in Radar and other branches.

You don't have to know a thing about Radio and Electronics. Over a period of 15 years, DeFOREST'S TRAINING, INC. has perfected a method of home training that GETS RESULTS.

We provide, for use in your own home, a BIG FOUR method that includes (1) commercial type Radio-Electronic parts and assemblies for valuable "LEARN-BY-DOING" experience at home; (2) a 16 Mm Motion Picture Projector and 12 reels of action-packed "LEARN BY SEEING" instructive movies to speed your understanding of important principles at home; (3) many easy-to-read loose-leaf lessons illustrated with handy fold-out diagrams; and (4) an effective EMPLOYMENT SERVICE to help you get started toward a good Radio Job when trained — or to assist you in starting your own Radio Business.

Both the Home Study and Chicago Laboratory courses of DeForest's Training, Inc. are accepted for your training. If you qualify under the "G.I. Law," you may obtain either training without cost to you.

No previous radio or electrical experience is necessary.

YOU CAN BUILD 7 DIFFERENT RADIO RECEIVERS

You "Learn-By-Doing" at home from 8 big Kits of radio parts and assemblies (similar to the equipment shown here). You build 7 different radio receiving circuits and dozens of other fascinating projects.

EMPLOYMENT SERVICE

Our effective Employment Service goes to work immediately upon the completion of your course to help you get started.

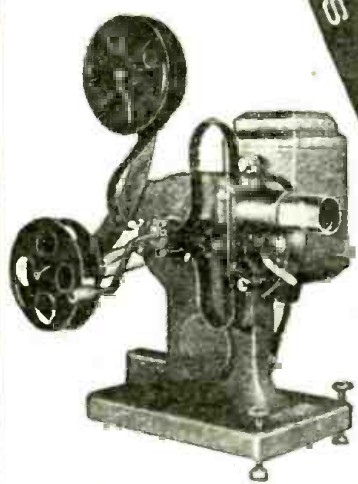

YOU CAN BUILD 133 FASCINATING EXPERIMENTS

You use "learn-by-seeing" movies. We supply you with a 16mm Motion Picture projector and 12 reels of information-packed film.

DeForest's Training, Inc. includes instruction in motion picture sound equipment, F.M. Radio and Television. In addition to our Home Study courses, RESIDENTIAL TRAINING is available in our new, modern Chicago laboratories. Ask us for information regarding same.

DeFOREST'S TRAINING, INC.
2533-41 N. Ashland Ave., Dept. RC-D7.
Chicago 14, Illinois, U.S.A.

Send me your big book "VICTORY FOR YOU" showing how I may make my start in Radio-Electronics with your modern home training plan. No obligation.

Name _____ Age _____
Address _____ Apt. _____
City _____ Zone _____ State _____

- If under 16, check here for special information.
- If a discharged veteran of World War II, check here.



Editorial: "Brand" vs. "Orphan" Radios	by Hugo Gernsback	17
Radio-Electronics Monthly Review		18, 19
The Crystal Radio Makes a Come-Back	by Harry Winfield	33
Customers and Laughs	by Raymond E. Wice	47
Radio Thirty-Five Years Ago		80

Electronics

French Radio-Model Auto	by Simon Coudrier	21
Television Over a Light Beam (Cover Feature)		22
Color Television, Part II	by H. W. Secor	24
An Electronic Photometer	by J. G. Reed	27
Antenna Principles, Part VIII—Metallic Lens and Electromagnetic Horn Antennas	by Jordan McQuay	39

Amateur Radio

250-Watt FM-AM Transmitter, Part I—The FM Modulator and Stabilizer	by Harry D. Hooton, W3KPX	31
V.F.O. Exciter or Transmitter, Part II—Constructing the Transmitter ..	by I. Queen, W2OUX	32
Parasitic Oscillations	by I. Queen	37
"Q"	by Raymond G. Johnson	38

Servicing

Radio Service Set Data—Browning FM-AM Tuner RJ-12		34
Improving the Midget Radio	by John Kwietinkes	51
Notes on Servicing	by Harry A. Nickerson	58
Guillotine for FM		70

Sound

Dynamic Pickup	by P. H. Russell	28
A Small Recording Studio, Part V—The Commonest Recording Troubles ..	by J. C. Hoadley	36

Test Instruments

"Submarine" Signal Tracer	by M. E. Blaisdell	26
Rapid Checker for Capacity-Continuity	by Alfred Shortcut	37

Construction

Reflexed Four-Tube	by W. T. Connatser	20
Narrow-Band FM for Ham Radios	by Norman L. Chalfin	23

Departments

Transatlantic News	by Major Ralph Hallows	40
Radio-Electronic Circuits		42
Technotes		44
Question Box		46
New Radio-Electronic Patents	by I. Queen	48
New Radio-Electronic Devices		50
World-Wide Station List	Edited by Elmer R. Fuller	52
Try This One		54
Communications		76
Book Reviews		79



Incorporating
SHORT WAVE CRAFT TELEVISION NEWS
RADIO & TELEVISION

HUGO GERNSBACK

Editor-in-Chief

FRED SHUNAMAN, *Managing Editor*

M. HARVEY GERNSBACK,
Consulting Editor

ROBERT F. SCOTT, W2PWG,
Technical Editor

I. QUEEN, W2OUX, *Editorial Associate*

ELMER FULLER, *Shortwave Editor*

ANGIE PASCALE, *Production Manager*

G. ALIQUO, *Circulation Manager*

JOHN J. LAMSON,
Advertising Director

ALFRED STERN, *Promotion Manager*

In A Future Issue:

Versatile portable recorder
Increasing repair volume
Ultrasonic circuits

On THE COVER:



Allen B. DuMont and the Photovision transmitter. Upper picture is relayed by Photovision, lower is direct from transmitter.

Chromatone by Alex Schomburg from photo by Warren Z. Iles.



Member Audit Bureau of Circulations

RADCRAFT PUBLICATIONS, INC. Hugo Gernsback, President; M. Harvey Gernsback, Vice President; G. Aliquo, Secretary

Contents Copyright, 1947, by Radcraft Publications, Inc. Text and illustrations must not be reproduced without permission of Copyright owners.

RADCRAFT PUBLICATIONS, INC. • PUBLICATION OFFICE 29 Worthington Street, Springfield 3, Mass. • EDITORIAL AND ADVERTISING OFFICES 25 West Broadway, New York 7, N. Y. Telephone REctor 2-9690.

BRANCH ADVERTISING OFFICES: Chicago: 308 W. Washington Street, Suite 1413, Chicago 6, Ill. Tel. Randolph 7363. Cleveland: Burdette Phillips, Manager, 405 Erie Bldg., Cleveland, Ohio. Tel. Main 9645. Detroit: Frank Holstein, Manager, 307-8 Boulevard Bldg., Detroit, Mich. Los Angeles: Ralph W. Harker, Manager, 606 South Hill St., Los Angeles 14, Calif. Tel. Tucker 1793. San Francisco: Ralph W. Harker, Manager, 582 Market St. San Francisco 4, Calif. Tel. Garfield 2481.

RADIO-CRAFT, July, 1947, Volume XVIII, No. 10. Published Monthly on 28th of month preceding date of issue. Allow one month for change of address. When ordering a change, please furnish an address stencil impression from a recent wrapper. All communications about subscriptions should be addressed to the Circulation Manager, Radio-Craft, 25 West Broadway, New York 7, N. Y.

SUBSCRIPTION RATES: United States and possessions, Mexico, Central and South American countries, \$2.50 a year; \$4.00 for two years; \$6.00 for three years. Canada, \$3.00 a year; \$5.00 for two years; \$7.50 for three years. All other foreign countries, \$3.25 a year \$5.50 for two years; \$8.25 for three years. Special rates for members of the Armed Forces in U.S., or those addressed by A.P.O. or F.P.O. mail, \$2.00. Entered at Post Office, Springfield, Mass., as second-class matter under the Act of March 3, 1879.

FOREIGN AGENTS: Great Britain: Atlas Publishing and Distributing Co., Ltd., 18 Bride Lane, Fleet St., London E.C.4. Australia: McGill's Agency, 179 Elizabeth Street, Melbourne. France: Brentano's, 37 Avenue de l'Opera, Paris 2e. Holland: Technisch Bureau Van Baerle, Bemelmans & Co., Heemsteedsche Dreef 124, Heemstede. Greece: International Book & News Agency, 17 Amerikis Street, Athens. So. Africa: Central News Agency, Ltd., Cor. Rissik & Commissioner Sts. Johannesburg; 112 Long Street, Capetown; 369 Smith Street, Durban. Natal. Universal Book Agency, 70 Harrison Street, Johannesburg. Middle East: Steimatzy Middle East Agency, Jaffa Road, Jerusalem. India: Magazines Distributors, 5 Bombay Mutual Annexe, Gunbow Street, Fort, Bombay 1.

Grasp the **NEW OPPORTUNITIES** in

RADIO ELECTRONICS AND TELEVISION NOW!

Modern Radio — FM Broadcast and Reception —
Television — Industrial Electronics; Power,
Control, Communications — new equipment
and methods demand new technical ability and
experience. Keep up to date with the latest.

**MODERN RADIO
EQUIPMENT FOR YOU
TO USE AND KEEP**

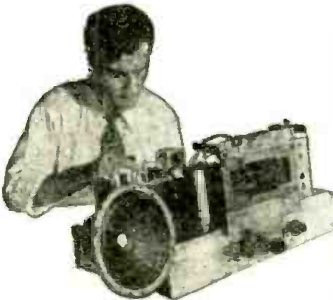

The very essence of National Shop Method Home Training is **EXPERIENCE**. You get actual experience by working with modern Radio and Electronic equipment—building many types of circuits. You may build a fine, long distance **MODERN SUPERHETERODYNE**, signal generator, miniature radio transmitter, audio oscillator etc.—many other standard actual operating pieces of equipment—conduct cathode ray and other experiments. This practical work advances with your training—**YOU LEARN BY DOING!**

**SEE WHAT NATIONAL TRAINING
HAS DONE FOR THESE MEN**

**COLLEGE PROFESSOR
APPRECIATES COURSE**

"I want to take this opportunity to tell you how much I appreciate this Course. Since being here at the College I have been able to put the theory to very good use. I have installed a P.A. system in the students' dining hall; today I am purchasing the required equipment to install a similar system in the large assembly hall; and at all of the large meetings held so far I have been assigned the task of setting up the portable P.A. system. I have also repaired several Radios for the boys and the professors, including car Radios. So once again, thanks for a fine Course. I am looking forward to the rest of the training with pleasure."

BROTHER V. BENEDICT,
Saint Mary's College,
Saint Mary's College, Calif.

**NOW MANAGER OF SERVICE
DEPARTMENT**

"I am really proud to be a National Graduate — It has helped me to hold my present position. Now manager of service department for Valley Music Company. Times have changed since I enrolled for National Training. I have an amateur Radio station to keep up on experiments in that field. WTHLF. Plus many, many sound installation problems. I have no time to call it "spare time" anymore —

thanks to National Schools."
DWIGHT J. ALBRIGHT,
Medford, Oregon

**FINDS A PLACE IN RADIO
BROADCASTING**

"I graduated from National three years ago at the age of 34. Since then I have been employed at Western Electric Co. and Federal Mr. Co. On April 30 I joined the engineering staff of WKNE in Keene, New Hampshire, as Transmitter Engineer. Prior to my starting your course I didn't know a thing about Radio. My rapid rise in this field is evidence of what your school can accomplish with anyone who is willing to spend a few hours a day with your training. May I express my sincere thanks to you and the faculty at National Schools."

FRANK J. SAMMER,
Keene, New Hampshire

**MORE THAN PAID FOR
COURSE IN SPARE TIME**

"I can sincerely say that my association in a few months with National Schools had paid off in dividends far greater than the tuition which is charged for the entire course, while at the same time increase my savings. Since beginning your Course, I have received two promotions and at the present hold the position of Radio Communications Chief full time."

FRANKLIN A. HILL,
Indianapolis, Ind.

Shop Method Home Training

By a Real Established Resident Trade School
With Its Own Television and Broadcasting Studios,
Shops and Laboratories

**TRAIN WITH ADVANCED
TECHNIQUE**

The good jobs in Radio Electronics now go to the men who are equipped to handle them. It takes training and experience. National Schools, one of the oldest and largest trade schools in the country, makes it possible for you to get this training right in your own home **IN YOUR SPARE TIME.**

National maintains modern resident training Studios, Shops and Laboratories where instructors and engineers are working constantly to improve training methods. **SHOP METHOD HOME TRAINING** is a logical extension of this practical system.

A **FREE** lesson that shows you how practical and systematic this new training method is will be sent you without obligation. You may keep and use this lesson to prove to yourself just how practical National Training really is.

Get one of the many **NEW JOBS** that demand new techniques and methods in Modern Radio. Get your share of the **NEW BUSINESS** that is settling the new sets and equipment demands. Experts agree that Radio, Television and Electronics present opportunities

**APPROVED FOR
TRAINING
UNDER GI BILL**

much greater than ever before!

Radio is expanding with far-reaching improvements in reception. No one knows yet how great the Television market will be. Electronics will touch almost every walk of life—in industry and in the home.

TURN YOUR INTEREST IN RADIO INTO A CAREER THAT WILL ASSURE YOU SUCCESS AND SECURITY.

**FIND OUT WHAT NATIONAL
TRAINING CAN DO FOR YOU**

Where do you stand today in modern industrial progress? What does the future hold for you? You owe it to yourself to investigate this opportunity. With National Training **YOU GET AHEAD FAST**—you may step into a good position or start a business of your own, with little capital, even before you complete your National Course.

Fit yourself for a career of independence, good earnings, success and security in one of the fastest growing fields in industry. For full information, just send your name and address on the coupon and mail it **TODAY.**

**Get This Book
FREE**

This big book presents the facts about the field of Electronics and your opportunities in it together with full information about the advanced National Training. Read it and make up your own mind that National Training will equip you for a great future. No salesman will call on you from National. The book is **FREE** with your sample lesson. Clip and mail the coupon **TODAY!**

FREE LESSON

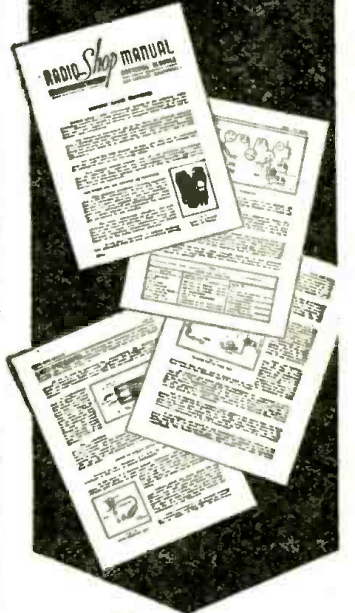

NATIONAL SCHOOLS

LOS ANGELES 37, CALIFORNIA EST 1905

MAIL OPPORTUNITY COUPON FOR QUICK ACTION

National Schools, Dept. 7-RC
 4000 South Figueroa Street, Los Angeles 37, California (Mail in envelope or paste on penny post card)
 Mail me **FREE** the two books mentioned in your ad including a sample lesson of your course. I understand no salesman will call on me.
 NAME AGE
 ADDRESS
 CITY STATE
 Include your zone number
 Check here if veteran of World War II



ESSE Specials!

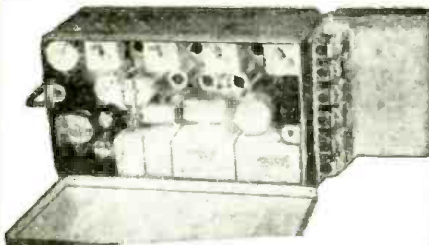

GLIDE PATH RECEIVER R 89/ARN 5 A
Formerly used for blind landing but adaptable to many other uses such as receiver for new police or citizen's band. Band of operation 326-335 MC on any of three pre-determined crystal controlled frequencies. Contains eleven tubes, 6 relays and other valuable parts. For 24 V DC operation. Size 13 3/4" x 5 1/4" x 6 3/8". Price, complete as shown **\$6.45**



13.2 MC-IF TRANSFORMERS
Slug tuned. Packed two per carton. Size 3" high overall with 1 3/8" x 3/4" mounting base. Price per pair **\$1.25**

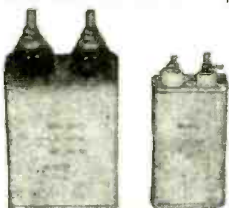

CAPACITORS
Cornell-Dubilier TJH-40010 G, 1 mfd, 4,000 V. Brand new. Price, each **\$4.85**
Cornell-Dubilier 4 mfd, 1,000 V. Brand new Price, each **\$2.25**

Aerovox—288 A, 2mfd, 600 V. Brand new—packed two per carton. Sold only in pairs. Price, per carton **\$1.95**

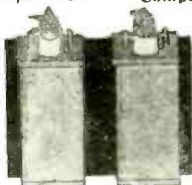

Potentiometers—Choice of 12 . . . \$2.85



Here is your chance to obtain good potentiometers at unbelievable prices. Any 12 of the listed controls \$2.85.

1. 500 M ohm CTS 1 1/4" dia. control with 3/8" shaft.
2. 3,500 ohm CTC 1 1/4" dia. control with 1/2" shaft.
3. 1,000 ohm CTC 1 1/2" dia. control with 3/8" shaft.
4. 100 ohm 1 1/4" dia. control screwdriver adjustment.
5. Dual 25,000 ohm Clarostat 1 5/8" dia. with 3/8" shaft.
6. 50,000 ohm AB 1 1/8" dia. control screwdriver adjustment.
7. 25,000 ohm dual 1 5/8" dia. control with 3/8" length shaft.



CAPACITOR KIT #1

Contains assortment of 25 various condensers, including two—2 mfd, 600 V. filters, one—1,000 mfd, 15 V. filter, four—1 mfd, 400 V. paper by-pass, three—3 gang midjet trimmers and assortment of micas and metal cased types. Complete Kit of 25 New Condensers **\$2.95**



KIT #2—50 PIECES, COILS and COIL FORMS

Practically everything ever desired from high voltage R.F. chokes, R.F. antenna coil for 550-1,500 KC. to ceramic and lucite coil forms. Complete 50 Piece Kit of New Make **\$1.35**

KIT #3—Twelve Frequency Crystals

Contains assortment of frequencies picked at random in the range of between 3,000 and 8,000 KC. Mounted in FT 243 holders. Price per Kit **\$2.95**

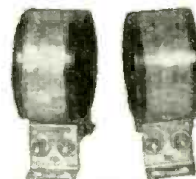

TUBE HEATERS

110V. AC or DC 100 Watt Heater. Ideal for many uses—such as line resistance, glue pot heater, baby bottle warmer, etc. Brand new—packed two per carton. 2 1/4" diameter. Price, per pair **75c**



MICRO SWITCHES

R-RS. brand new in original box. Packed 10 per carton. SP type normally closed. Price per carton **\$2.35**

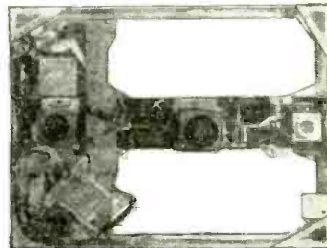

RACK UNIT FOR SCR-522

Contains—relays, ratchet motor jones and amphenol connectors, switches, condensers, etc. Brand new in original box. Motor will operate on from 6-24V. DC. Price **\$1.85**

**TERMS:
CASH
with
ORDER**



Radio Company
130 W. New York St. • Indianapolis 4, Ind.

Here are THE FACTS for the Radioman Who Cares about Tomorrow.

**CREI Offers the Modern Technical Training You Need
to Qualify for the Good Jobs — Good Salaries —
Secure Futures That Can Be YOURS**

Face the Future and Face the Facts. Radio is moving at a pace so fast, that it is far beyond the expectations of the most optimistic authorities a short time ago. New receivers contain FM, standard and short wave AM, Television—phonographs with automatic record changers. Projection Television receivers employ 20,000 volt power supplies—some have in excess of 40 tubes. Two-way installations are becoming standard equipment on buses, trains, trucks and taxicabs. Many industrial plants have over 40 different electronic devices. These are the types of jobs you'll have to service from now on. Such rapid expansion makes progressive servicemen realize the need for authoritative training. It should be a timely warning to others that they must "re-tool" their technical knowledge in order to keep pace.

The Industry has advanced so rapidly—that, while it has created good jobs and remarkable opportunities—most of them are "over the heads" of the average radioman.

That's why it is so important, if you have an "ounce of ambition", to prepare now. You can increase your technical ability with the thorough, practical technical training for which thousands have enrolled with CREI since 1927. CREI home study courses in Practical Radio-Electronics and Television Engineering offer you the chance to acquire the profitable knowledge and ability to enable you to keep pace with this zooming industry.

You owe it to yourself — to your family—to equip yourself with the ability to go after and get the good jobs that are actually "going begging" for adequately trained men. You can start training NOW in your spare time, but you must be ambitious and willing to study seriously. Technical education is one of the very best investments you can make. It will pay you dividends all the rest of your life. It costs only a postage stamp and a few minutes' time to write for the interesting facts. Mail the coupon today.



SURVEY PROVES FACTS!

The following are excerpts from comments made in a survey of CREI graduates recently completed. The original names and statements are in our confidential records.

"The course has been very helpful in the everyday things that crop up in the broadcast field and is especially useful to one employed in a broadcast station."
—A Chief Engineer—4.23.47

"My CREI training has helped me with radio theory so that I was prepared to undertake problems in design, construction installation and maintenance as they came along."
—A Chief Engineer—4.24.47

"I found CREI even more than I expected; I have gained confidence and respect for my fellow workers as well as my employer, and will always feel that CREI has given me the foundation necessary for whatever I may accomplish in radio."
—Maintenance and Operation—4.23.47

"Radio is changing so fast today that without the clear, concise training that CREI provided, I would never be able to look such things in the "teeth", as FM, Facsimile and Television."
—A Chief Engineer—4.22.47

"As far back as I can remember in my "radio" life one eternal question mark has been before me—WHY DOES IT WORK THAT WAY? Many seem content to take another's experience and word as Gospel, but all that did for me was to make me wonder the more. Truthfully, CREI opened many doors, and things which were beyond comprehension to me when I began my Radio Electrician career in the CAA are now not only acceptable without question but fully understood."
—A CAA Radio Electrician—4.28.47

"The knowledge gained from study of the CREI course is valuable to me in my daily work. I expect to take a written examination sometime this summer for probational appointment to the position of FCC Radio Engineer, and if I pass the exam as I hope to, considerable credit will be due CREI training."
—A FCC Radio Inspector—4.29.47

Mail Coupon Today For This 24 Page Free Booklet!

If you have had professional or amateur radio experience and want to make more money, let us prove to you we can give you the training you need to qualify for a radio job. To help us intelligently answer your inquiry — PLEASE STATE BRIEFLY YOUR BACKGROUND OF EXPERIENCE, EDUCATION AND PRESENT POSITION.

VETERANS! CREI TRAINING AVAILABLE UNDER THE "G. I. BILL!"

Capitol Radio Engineering Institute

An Accredited Technical Institute

DEPT RC-7 16TH AND PARK ROAD, N. W. WASHINGTON 10, D. C.

Branch Offices: New York (7), 170 Broadway • San Francisco (2), 760 Market St.



CAPITOL RADIO ENGINEERING INSTITUTE

16th & Park Rd., N. W., Dept RC-7, Washington 10, D. C.

Gentlemen: Please send me your free booklet, "CREI Training for Your Better Job in RADIO-ELECTRONICS", together with full details of your home study training. I am attaching a brief resume of my experience, education and present position.

CHECK PRACTICAL RADIO ENGINEERING COURSE PRACTICAL TELEVISION ENGINEERING

NAME _____

STREET _____

CITY _____ ZONE _____ STATE _____

I am entitled to training under the G.I. Bill.

SPECIAL VALUES ... for immediate delivery!

CONDENSERS

Cat. No.	Cap. MFD.	Working Volts	Your Cost
C110	1	5000 Oil	\$ 3.95
C111	3	4000 Oil	\$ 4.95
C112	1	1000 Oil	44c
C114	8	600 Oil	95c
C115	2	600 Oil	49c

Westinghouse 1 MFD 6000 volts WVDC \$7.95
 Westinghouse 1 MFD 10,000 volts WVDC \$12.95
 General Electric 25 MFD photo flash pyranol capacitor, 2000 VDC—INT. 14.95
 IRC type ME resistor 200 wt. taped at 3000, 7500, 23, 750 ohms. Brand new 49c
 144 MC. Radar Osc. uses 15E or with variable coupling. Complete less tube \$ 3.95
 Thordarson 300MA Power Transformer 110 or 220 V 60 cy. Input. Secondary 550/550 tapped at 450/450 Extra bias winding 200/ct/100 at 50ma. 18 lbs. \$ 4.95
 BC 191E less tubes and tuning units. \$14.95
 5V Filament Transformer 60 amps. 22 lbs. \$ 5.95
 Ear Phones. 2000 ohms, used—in good condition. 95c
 Ass'd resistors 1/2 watt fully insulated, in popular ohmages. Cat. No. R-5 per 100 \$ 1.49



NEW BC 223 AX TRANSMITTER

801 Oscillator and 801 Power Amplifiers, 2-46 Modulators and 1-46 Speech Amplifier 4 Xtal Frequencies and Master Oscillator on selector switch. 10 to 30 watts output. Tone Voice or C.W. Mod. Ideal for 80 meter band. Comes with 3 coils TU 17A 2000-3000 Kc. TU 16 3000-4500 Kc. TU 25 3500-5250 Kc. Black wrinkle case. Includes 2 separate cases to store extra coils. Frequencies chart and tubes included, packed in original cases, less crystals at this low price. Cat. No. MT-100... Shipping weight 125 lbs. **\$29⁹⁵**

MICA CAPACITOR .002 MFD 3000 VDC. Cat. No. RT-101... 49c
IF TRANSFORMER Mounted in aluminum shield can. 1500 KC, with air trimmer, impedance coupled type. 95c
30 MC IF Transformer in square aluminum can, silver slug tuned 29c

PHOTO FLASH TUBE
 12,000,000 lumens light output. Ignition coil included. 10,000 Flashes. Dia. 8.88". 828's, 805's, 2037's. grams turn, on request. **\$8⁹⁵**

FILAMENT TRANSFORMER
 Thordarson Pri. 110 V 60 cy.—Sec. 6. 3V, 6A, CT. Cat. No. FT12... **\$1⁴⁹**

MINE DETECTOR
 SCR 625 used. Brand new... **\$49⁹⁵**
 69.00
 Ass't mica condensers, Cat. No. C-12—per 100... \$ 1.95
 Wafer Sockets, 4-5-6-7 and 8 prong. Cat. No. WF-4—Per 100... \$ 2.95
 12" Utah P. M. Speaker, Alnico No. 5 with 6F6 output transformer. Cat. No. ST-100 \$ 6.95
 Ass't knobs push on wood and plastic. Cat. No. KP-100—per 100... \$ 1.95
 Johnson sockets No. 210-25W. Cat. No. JS-210... 49c
 Sockets for acorn tubes. Cat. No. AT-10... 19c
 Jacks PL 55, PL 68... 15c
 Powdered iron slug with solenite coil form to match, ideal for broad tuning. E. C. O. Powdered 3/8 slug... 23c
 1 Meg. Shalleross Acra—Ohm wire wound resistors ± 1W... 10c
 89c

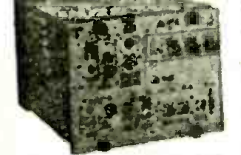

Transmitter & Receiver

The famous boat anchor, widely used on the 144 MC band. Complete power supply 110V—AC. Less power transformer and tubes. Shipping weight 100 lbs. **\$14⁹⁵**

MODULATION TRANSFORMER 1KW \$14⁹⁵

Shipping weight 52 lbs.
 RCA modulation transformer is conservatively rated at 550 Watt audio to modulate that new KW rig. Really rugged construction with protective flashover gaps, which are adjustable. Terminals and gaps are mounted on a "Mycalex" terminal board. The laminations that make up this transformer are of high audio quality and are extremely thin, making it impossible for the core to "chatter or talk".
 Audio Watts—550 Sec. #1-450 Mils Sec. #2-80 Mils Turns Ratio—Pri. Sec. #1-1:1 Pri. Sec. #2-5:1 Pri. Sec. #2 Tap-25:1. Impedance Ratio—Pri. #1-1:1 Sec. Pri. Sec. #2-25:1 Pri. Sec. #2 Tap-625:1. DC Resistance—Pri. 135 ohms Sec. #1, 112 ohms; Sec. #2, 99 ohms. Transformers insulation tested: Pri. 8000V.; Sec. #2-2000V. to the rest of the coils and core. Primary center tapped for Class "B" modulators. Secondary #2 will carry 80 Mils to modulate screens of beam power or screen grid tubes. Primary will match any Class "B" tubes up to 10,000 ohms plate to plate, such as 810's, 75T's, 8005's, 2B120's, 203's, H512's, 211's, 813's, 828's, 805's, 2037's. Size 9 1/2" wide, 7 1/2" deep, 7 1/4" high. Heavy channel iron mounting brackets. Weight approx. 40 lbs.

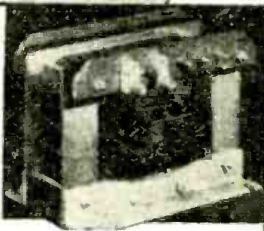

BC 654 TRANSMITTER & RECEIVER

Frequencies range 3800-5800 KC.—calibration every 10 KC.—with crystal oscillator checked every 200 KC. Power output 17 watts, voice or CW. Complete with tubes and 200 KC. X-tal.

\$14⁹⁵
CHOKES

THORDARSON T48003
 2H—7H 550 MA swing choke. Size 4 1/2 x 5 1/2 x 5 1/2. Square black crackle case. Cat. No. FC-205. **\$5⁹⁵**

Thordarson 8HY 150M choke, Cat. No. FC201—95c
 Thordarson 8HY 175 Mchoke, Cat. No. FC202—\$1.49
 Thordarson 12HY 25M choke, Cat. No. FC203—39c
 Thordarson 8HY 350M choke, Cat. No. FC204—\$4.95

Receiver & Transmitter
 SCRS22, 100-156 MC. Used, in good condition. Complete with 18 tubes and crystals. **\$29⁹⁵**



BUTTERFLY Condensers

Oscillator butterfly assembly condenser 76 to 300 megacycles with acorn tube socket. Mounted on condenser. Catalog No. BC 3. **\$1⁹⁵**
 Type B—frequency range 300 to 1000 megacycles to be used with 368 AS dorknob tube. Cat. No. BC2. **95c**

Sockets part of assembly

TUBES	TUBES	TUBES
813 \$ 5.45	IT4 354	IRS
RK60 1.25	IS5 6SL7	6SA7
VT127 2.95	3Q4 65N7	65A7
VR150 .69	6SN7 65A7	
829 2.45		
872 1.95		
211 1.45		
654 1.50		
656 .95	955 .65	9004 .65

59c each

BRAND NEW SCR-269-F AUTOMATIC DIRECTION FINDER RADIO COMPASS

COMPLETE WITH COMPONENT PARTS **\$75⁰⁰**

The radio compass SCR-269-F was designed to be the primary radio navigation compass for the United States Army and Navy Air Forces. Constant reception is possible day or night so that fixes can always be made to establish the plane's or ship's location. The azimuth indicator is divided into 360 degrees and is connected to the loop antenna, therefore making it possible to navigate the ship in any direction as preset on the dial. Plotting fixes is accomplished by selecting two or more stations and plotting these on the navigation map. The point of intersection of these lines, indicates the location of the craft.
 This equipment comes complete with 17 tubes superheterodyne receiver which is tunable from 200-1750 KC in three bands. A complete Instruction Book for operation and maintenance accompanies this equipment.

- Commercial air lines
- Air charter planes
- Yachts
- Fishing vessels
- Home radios
- Ham operators
- Air freight planes

- 1 Radio Compass Receiver BC-433-F
- 1 Radio Control Box BC-434-F
- 1 Mounting FT-213-A
- 1 Mounting FT-224-F
- 1 Loop LP-21-F (includes Dehydrator)
- 1 Cord CD-365-A
- 1 Indicator I-81-F
- 1 Relay SW-172
- 1 Plug PL-112
- 1 Plug PL-118
- 1 Plug PL-122
- 1 Dehydrator Hose, Fitting & Clamps 10 foot length
- 1 Operating & Maintenance Handbook
- 1 Coupling MC-136
- 1 Tuning Shaft MC-124 (300')
- 1 Insulator IN-79
- 1 Insulator IN-81
- 1 Shaft Casing and Spline Drive
- 1 Shafting F/MC-124 (300')
- 5 Nut F/MC-124
- 5 Spline F/MC-124
- 5 Sleeve F/MC-124
- 1 Transformer C289A5-R16-F

WRITE FOR

HRC

FREE BULLETIN



RADIO COMPANY
 5249 GRAND RIVER - DETROIT 8, MICH.

Minimum Order \$2.00 F.O.B. Detroit

Mich. Sales Add 3% Sales Tax

20% DEPOSIT REQUIRED ON ALL C.O.D. ORDERS

Rectifier Transformer

117V AC input, 62V output at 3.5A.
Rectify and use with filter and
rheostat to run your 12 and 24 volt
equipment \$3.95

"Communications"

Has the Electronic Equipment You Need

GN-45 Hand Generators

Plate & Fil Supply Output
500 VDC 140 ma and 6V 3A.
8"x8"x6" \$4.95

Selections From Our Huge Microwave Stock

10 CM. PLUMBING

Sand Load—Wave guide section. App: 23"
high with cooling fins (Dummy Ant.) \$35.00
Wave Guide to Coax, with flange Gold
plated 10 CM 25.00
Standing Wave Detector, rigid coax
58 ohm 5.00
Coax rotary joint, with mounting plate
Wave guide (16 ft. lengths) per foot
10 CM 2.00
Heavy Flange for mounting wave guide 2.00

3 CM PLUMBING

Wave guide 90° bend E Plane, 18" long \$ 4.00
Wave guide, 18" long S curve, cover to
choke 3.50
Rotary coupler, wave guide in and out,
choke to choke 6.00
Duplexer section using 1B24 10.00
Wave guide 5 ft. length, per ft. 1.95

SEND FOR OUR NEW

1.25 CM. PLUMBING

T section choke to cover \$ 4.50
Flexible section choke to cover 3.00
Mitered elbow and S section cover to choke 3.50

MICROWAVE TEST PARTS

SPECIAL—3 cm. vernier drive dial, and
resonant cavity Macquire Wavemeter
#1539TFK, 21GA \$20.00
4 inch directional coupler, 20Db drop 3 Cm
—in and out, coax probe 5.50
8" long directional coupler, CU-90/UP-
20Db drop has short right angle (10 cm) 5.50
1-222A Signal Generator—8-15 MC and
150-200MC 5 MC crystal osc. for calibration
power input 115 volts, 60 cycles AC 47.50
W.P. Signal Generator 1-138 A (10 cm)
indicator is a 0 to 200 microammeter.
Value \$400. Our price 75.00

MICROWAVE FLYER

TUNING UNITS Ideal for E.C.O. Rig



From BC191 and 375—contains coils,
chokes, dials, condensers; send your
frequencies \$2.75

TRANSMITTER BC 375

Air Corps version of the famous BC-191.
Used; supplied with one tuning unit,
meters, coils, condensers, etc. Special \$9.95

SO RADAR

10 CM SURFACE SEARCH RADAR SETS
SO-9 new with spares—complete installations.
SO-13 used, in excellent condition.
WRITE FOR PRICE AND DETAILS

RADAR UNITS

SN Radar, complete, very compact,
portable, new \$650.00
RC 148 IFF, includes trans. rec. BC1267
and pwr. unit RA105-A. Operation:
117v/60c—157 to 187 MC 47.50
SA RADAR, PPI Unit, from SA-2 Radar
RCA 7 in scope 165.00
SQ RADAR Complete Console, GE. B.
PPI, or A. Presentation 250.00
SLA ppi console, WE Radar, good cond. 225.00
AN/APG-5 Trans.-rec. 2500MC Range
radar uses lighthouse tubes 100.00
SCR 518 RADAR ALTIMETER—20000
ft. range 3" calibrated scale, 515MC,
complete installation. New 279.00
RANGE UNIT SCR268—Radar.
115v/60c 15.00

MAGNETRONS

3131 (1 cm) Magnetron \$20.00
3131 Fil. Transformer \$6.50
2132 (JAN) 10 cm,
300 Kw peak pulse
listed \$200. OUR
PRICE \$25.00
720—BY MAGNETRON
W.E. \$25.00
ELECTRO - MAGNET
for 720-BY \$13.50
QK59, QK60, QK61,
QK62. Pkgd. Mag-
netrons 10 cm Band



\$45.00 each

Magnets for Magnetrons \$12.00
KLYSTRON oscillator tubes 2K25/723 ab
designed for 3 cm operation. New. With
complete data. Listed at \$38.00, re-
duced to 7.75
McNally Klystron 707B (10 CM) with
cavity 15.00
Tunable Cavity for 707B 3.50
Thermistor Beads (D-170396), for use with
UHF and Micro-Wave Equipment (List
\$7.00). In separate sealed containers95
Thermistor Buttons D 16839195
Magnet for 3 centimeter magnetrons, in-
corporating a magnetron stabilizer cav-
ity, Cinnagraph Type UC 210 22.50
W.E. Converter BC 437A 19.00
Parabolic Reflector—Ribbed—For opera-
tion in 3000-4000 MC Range. Made by
Budd. Has Mounting Neck. New 85.00
Dipole—Can be used with above 5.00

DIRECTION FINDER

Designed for Marine Use

Navy DP12, covers broadcast and
marine frequency bands, 100-1500
UC. Complete installation with ac-
cessories and spares. Operation:
115V AC or battery pack. Loop
can be operated remotely \$195.00

H. V. TRANSFORMERS



AMERTRAN PLATE
TRANSFORMER, 115 v
—60-cycle primary, 6200
volt-ct-700 mil secondary.
Size
11"x14"x10". \$39.95

AMERTRAN CHOKE—RMS test 15KV,
1 H. 3 amp. DC, DC resistance 7.5 ohms \$8.95

Power and Filament All Primaries: 117V 60 Cycles Secondaries

#5084—1000V CT and 3800V CT at 250
ma, and 6.3V at 1.5A \$6.95
#5114—1500V CT at 200ma and 5V at A 6.95
#5054—980V at 450ma—\$4.95. Per pair 9.00
#5109—6180V at 200ma 14.75
#5057—6.3 CT 1A, 5V CT 3A, 5V CT 3A 2.75
#5104—6.3V at 1A, 6.3V at 1A, 6.3V
at 1A 2.45
#5126—5V CT 3A, 5V CT 3A, 5V CT
at 6A 3.25

CHOKES

8.5hy, 125ma, 1780V test \$1.45
Dual: 7hy, 75ma, 11hy 60ma, 1780V test 1.95
Very conservatively rated

Sonar Sound Detection Unit!

Ideal for detecting under-
water sounds, such as fish
swimming in schools, with-
in a 15 mile area. Using
a Rochelle salt crystal,
which is about 1000 times
more sensitive than quartz,
as the active unit the
sound is transmitted up a
60 ft. length of cable. It
is completely enclosed in a
solid rubber sheath whose
physical size is: 16 1/2" L,
3 1/2" dia. This sound de-
tector was originally used
in harbor defense. Coupled
to an audio amplifier, this
can be found to have many
valuable applications.



\$6.95

Similar to above but 3 times longer and
with more crystals for greater sensi-
tivity. Model JR \$12.50

HEADPHONES

8,000 ohms impedance, complete
with 6 ft. cord, plug, detach-
able cushions, leather head-
band. Brand new \$4.95
Used, in good condition 1.00



RECEIVERS

NEW ARC-5 SUPERHETS... \$6.00

Tubes (included) 3-
12SK7; 1-12K8; 1-
12SR7; 1-12AG. Ranges
(Specify freq. desired)
1500-3000 Kc; 3-6 Mc;
6-9.1 Mc. Power: 24-28
VDC for only, new \$6.00
Extra—To Go With
ARC-5 Dynamotor \$1.95
Control Box \$1.00
Control drive cables 1.50
Single mounting rack 1.00
Double mounting rack 1.65
Shock mounts95



All parts interchangeable with SCR-274-N

RCA 12-TUBE SUPERHET

Frequency: 100 to 1500KC. Used but in
excellent condition. Power supply 115V
AC 24" L x 18" W x 13" H \$29.95

That Condenser You Need

Oil Type

1 mf 300 vdc	\$.20
2 mf 300 vdc25
4 mf 300 vdc30
4 mf 400 vdc50
5-5 mf 400 vdc	1.05
1 mf 500 vdc G.E.25
2 mf 500 vdc25
.25 mf 600 vdc20
.85 mf 600 vdc25
1 mf 600 vdc30
8-8-1 mf 650 vdc	1.45
1-1 mf 700 vdc G.E. Prr.	2.00
2 mf 800 vdc35
4 mf 800 vdc60
10 mf 800 vdc85
1 mf 1000 vdc75
1 mf 1000 vdc25
2 mf 1000 vdc89
4 mf 1000 vdc	1.00
19 mf 1000 vdc	1.40
1 mf 1500 vdc95
4 mf 1500 vdc15
2 mf 660 ac/100085
4 mf 1500 vdc	1.20
1 mf 2000 vdc	1.00
1 mf 3000 vdc	4.95
1 mf 7500 vdc	12.50
.25 mf 20,000 vdc	17.50
10-10-10 mf Synchro cap 90v/60c	2.50

SANGAMO CAPACITORS

C-3 .005 10KV \$17.50
.0001 10KV 15.50

We have a wide selection of 120 watt resistors.
Send your requirements.

ALL MERCHANDISE GUARANTEED. MAIL ORDERS PROMPTLY FILLED. ALL PRICES F.O.B.
NEW YORK CITY. SEND MONEY ORDER OR CHECK. SHIPPING CHARGES SENT C.O.D.

SEND FOR FLYER

COMMUNICATIONS EQUIPMENT CO.

131-C Liberty St., WH 4-7658, New York City 7, N. Y.

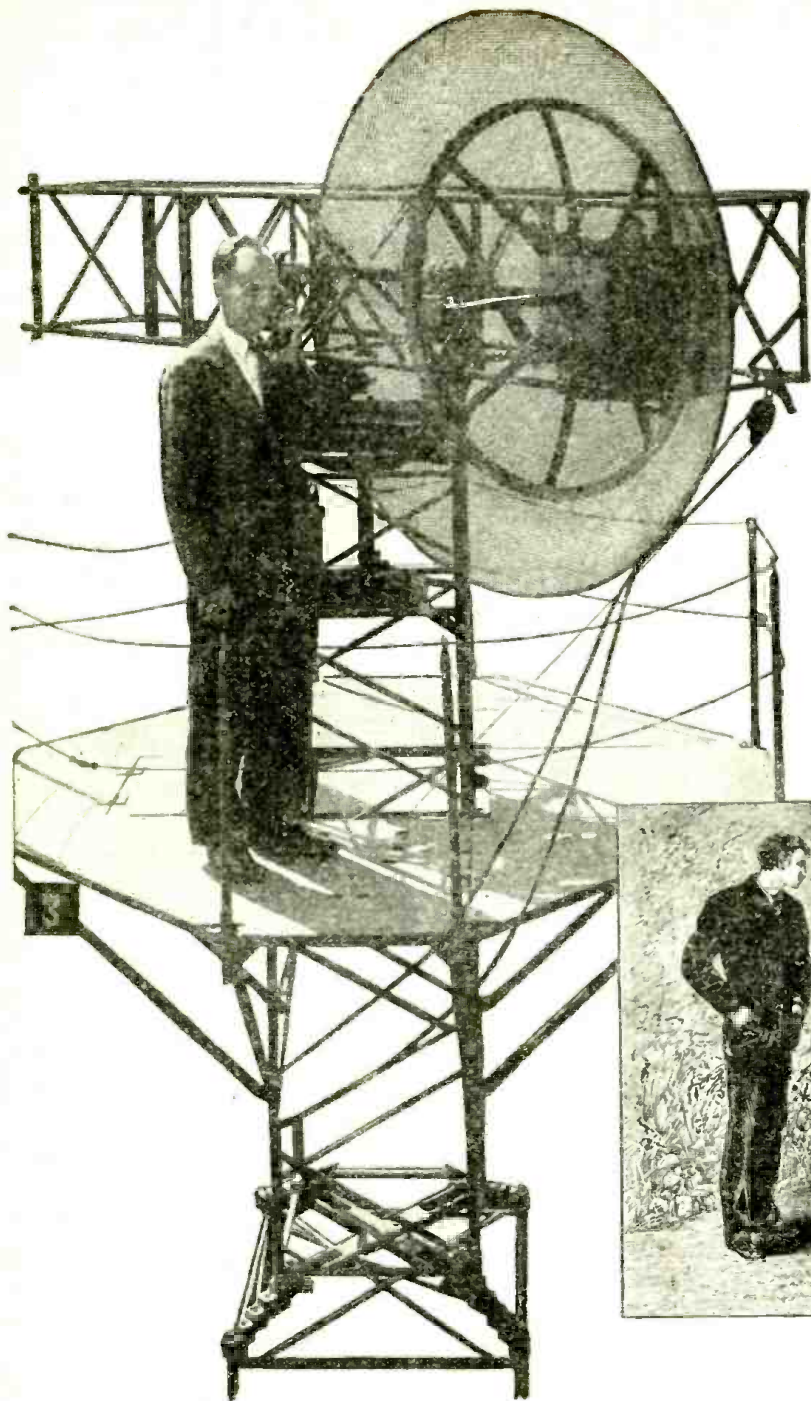

Words that rode on a beam of light

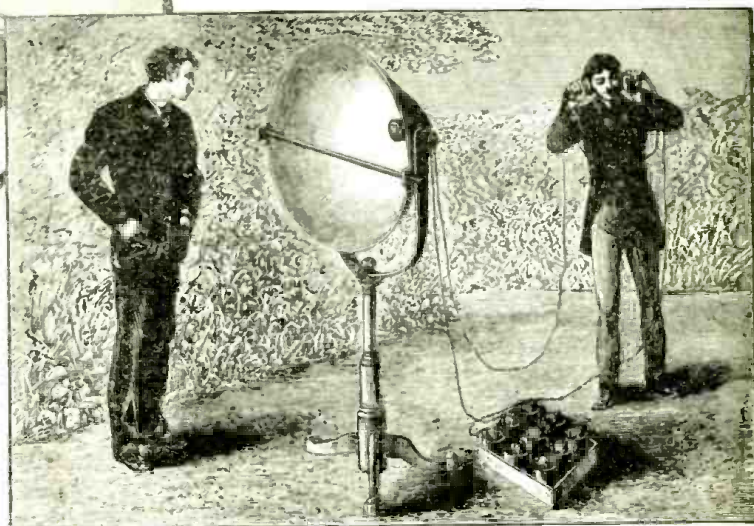

If Alexander Graham Bell could look at the microwave antenna in the illustration, how quickly his mind would go back to his own experiments, 67 years ago!

For in 1880 the inventor of the telephone had another new idea. Speech could be carried by electric wires, as Bell had demonstrated to the world. Could it be carried also by a light beam?

He got together apparatus—a telephone transmitter, a parabolic reflector, a selenium cell connected to hand-phones—and “threw” a voice across

several hundred yards by waves of visible light, electromagnetic waves of high frequency.

Bell's early experiment with the parabolic antenna and the use of light beams as carriers was for many years only a scientific novelty. His idea was far ahead of its time.

Sixty years later communication by means of a beam of radiation was achieved in a new form—beamed

microwave radio. It was developed by Bell Telephone Laboratories for military communication and found important use in the European theater. In the Bell System it is giving service between places on the mainland and nearby islands and soon such beams will be put to work in the radio relay.

In retrospect, Bell's experiment illustrates once again the inquiring spirit of the Bell System.

BELL TELEPHONE LABORATORIES



EXPLORING AND INVENTING, DEVISING AND PERFECTING FOR CONTINUED IMPROVEMENTS AND ECONOMIES IN TELEPHONE SERVICE

"BRAND" vs. "ORPHAN" RADIOS

The Trend of Price Structure in Radio Receivers

By HUGO GERNSBACK

IN the postwar readjustment period through which the country is now passing the radio industry is caught in the same predicament as are all other major industries in the United States.

Due to the high price scales engendered by World War II in the period between 1941 and 1945, the cost of commodities has practically doubled in the United States.

The inheritance of the war price structure is still with us and it will take considerable readjustment before a lower price trend can again be achieved.

In the meanwhile, the many strikes which have upset the economy of the country have taken their toll with the result that earning power has been curtailed while the savings of the workers have approached the vanishing point. The consequent result is that the purchasing power of a large cross section of the country has been seriously impaired. The high prices on almost all commodities make it impossible for the greater proportion of the population to buy the merchandise which it needs, simply because the spiraling price structure outruns the earning power of most of the population today.

As in previous periods of inflated prices, the increasing resistance of the buying public has reached its zenith, so that only necessities are bought now. This resistance will continue until the adjustment period has run its course.

It would also seem that for the time being general wage increases have largely ceased. We will probably soon see stabilization of wages and income of the greater percentage of the population in this country, and a downward adjustment of our price economy, thus making further immediate wage increases unnecessary.

All of this is not new—it has been said time and again by many economists in the country—and it would seem reasonable to expect a slow downward trend of prices from now on. There may be exceptions in certain luxury and allied industries, but the main industries know now that the public will not come back into the market to buy merchandise on a large scale until it is priced within the reach of the majority in this country.

The radio industry is in no different position than other major industries and the buying resistance of the public necessarily includes radio as well.

The radio industry, too, is in the unhappy position where their cost of raw materials, parts, etc., and their wage cost is at an all-time high, making it at the moment almost impossible to reduce prices without bankrupting many firms. All materials, parts—with practically no exceptions—that go into the making of radio sets are at present—or have been until very recently—at their peak. The same is true of wages, coupled with the fact that the daily output of the workers nowadays is generally below what was par before the

war—thereby distorting and aggravating the condition still more.

The radio industry is further bedeviled by the additional fact that many of the newer and smaller firms could not withstand the buying resistance of the public and had to throw upon the market, in some of our large centers, a certain amount of distress merchandise. This aggravated the picture because when large advertisements appeared in the newspapers offering radio sets and other radio merchandise at greatly reduced prices, the public jumped to the conclusion that all reputable set makers would have to follow suit and reduce their prices drastically, too. This, however, did not prove to be the case, because many of the responsible old line manufacturers prefer to fill warehouses with radio receivers rather than see them sacrificed below their cost.

That the large radio set manufacturers mean what they say, and that they do not contemplate immediate large scale price cuts, is best reflected in a statement from one of the foremost radio manufacturers, who issued the following statement just as we go to press:

"Although no price changes are contemplated at this time, should any downward revisions in price occur, the trade is guaranteed to be rebated for the difference between old and such new prices as may be established."

According to this manufacturer, the guarantee covers inventory purchased (by dealers) between the dates of April 15, 1947, and December 31, 1947.

Dealers and radio stores in many U. S. centers, it appears, have recently refused to buy standard brand radio receivers because they were afraid to stock up on leading brand radios which they felt would soon be offered at reduced prices.

It is necessary, however, for the dealer and storekeeper to stay in business, therefore he must buy some merchandise that he can turn over quickly. So we now have again—as even before the war—the spectacle of a number of "no-name" brands, that is, unknown radios which are flooding the market in earnest. Such receivers are often advertised for less than one-half of the price of established makes of similar sets. That does not mean that they compare in quality or performance with standard brands. Often many of these unknown receivers are thrown together by so-called "bed-room manufacturers," of whom there are many hundreds in this country.

These firms buy war surplus and other odd parts wherever they can be found at a price. The cabinets usually are of unseasoned, poor-grade wood and will not stand up for long, nor will the sets themselves. There is very little real factory inspection or testing and as the parts are not uniform and often include discards and "seconds," the receivers themselves are no bargain no matter at what price they are offered.

(Continued on page 71)

RADIO-ELECTRONICS

Items Interesting to

RADAR has been recognized by the Civilian Aeronautics Administration, it was revealed last month. In a move which came as a distinct surprise even to its own field personnel, the Administration abandoned its previous policy of considering ground-controlled approach (GCA) radar as a purely "supplemental" aid in bringing aircraft safely to earth under instrument-weather flying conditions and issued instructions that it may be used as a primary airport-approach system.

This step reverses the CAA's steadfast earlier assertion that its new GCA installations at La Guardia Field, Washington and Chicago would be utilized only to monitor aircraft let-downs through soupy weather on the CAA-sponsored runway localizer and glide-path radio beams of the instrument landing systems (ILS) already installed at dozens of air terminals throughout the country.

TWO AND ONE-HALF WATTS is the power of an FM broadcast transmitter installed last month at Syracuse University. Proposed, designed and installed by General Electric Co. as a suitable unit for intra-mural broadcasting, it was the object of a special visit of the FCC. The Commissioners are very much interested in the possibilities of low-wattage university and school FM transmitters.

The establishment of such stations on a wide scale would encourage adult as well as student educational programs and at the same time help train thousands of students to help meet the demand developing for commercial FM station personnel. With this low-powered equipment designed to assist educational institutions with limited budgets, it will be possible for many schools to get on the air quickly, G-E officials believe.

Under average conditions, the range

from the antenna point of the transmitter provides an excellent signal in all parts of the campus and surrounding student living centers.

FM broadcast stations would continue and extend the present system of "college broadcasting" now carried on at several universities with carrier current sent over electric light lines, or in some instances, over heating-pipe systems.

TELECOMMUNICATIONS proposals by the United States delegation to the International Telecommunications Conference now meeting at Atlantic City, New Jersey, include a Central Frequency Registration Board and permanent International Radio Consulting Committee. A third proposal is that emergency administrative radio conferences be called from time to time to deal with problems requiring immediate solution.

The Atlantic City conference, which opened May 12, has the important work of revising the Cairo Radio Regulations, which have guided international radio since 1938. Fifty-nine nations and 8 international organizations were represented by more than 700 delegates at the opening session.

SUPERSONIC LAUNDRIES may be the next development in the application of this branch of electronics to industry. The possibility of using supersonics to wash clothes was revealed last month by Sir Edward Appleton, radar pioneer and secretary of the British Department of Scientific and Industrial Research.

Sir Edward explained that dirt is held to fabric by electrical attraction. Soap and other solutions, called detergents, are now used to break this electric bond.

If current research is successful, sound waves may do part of the job in the future. Supersonic vibrations are being used to shake out the dirt particles from clothes. Sound waves would also emulsify the dirt in the cleaning solution to keep it from getting back on the clothes.

The idea of using sound waves to shake dirt off fabrics was developed from the wartime Asdic submarine detector.

COMMUNICATIONS EXPANSION in the vehicular field is so great as to require a special FCC hearing, which has been set for September 8.

The common carrier type of mobile service is expanding at "a very rapid" rate, according to the FCC. Common carrier highway service is proposed for 79 cities on the mainland of the United States and 2 in Hawaii. More than 3,000 mobile units have been authorized in this class. These, together with associated fixed stations, represent an investment of \$4,500,000.

Urban automobile units have been authorized to the number of 5,600 mobile units. The total investment in this field is estimated at about \$6,000,000. Expansion is delayed only by the inability of radio manufacturers to furnish the equipment as rapidly as desired.

The telephone companies propose service which will extend wire telephone communication to and from land, sea or air vehicles. Three types of common carrier service are in prospect: communication between any regular telephone and any mobile unit; special two-way dispatch service between a central office and specified mobile units; and a one-way signalling service to mobile units.

RADIO LISTENERS want high fidelity, Dr. Harry F. Olson, head of the acoustics research laboratory, RCA Laboratories, reported last month. Recent surveys have shown that persons listening to music reproduced through standard amplifiers and loudspeakers have not expressed preference for full-range fidelity. Therefore certain engineers hold that full-fidelity is unnecessary and merely adds to cost of amplifier equipment. Others hold that the results were not due to a preference for restricted-range music, but to imperfections in reproduction which were reduced with reduction of audio frequency range.

Dr. Olson made his tests with a live orchestra, eliminating all factors which could be introduced by amplifiers or speakers. Tests showed that 75 percent of listeners between 30 and 40 years of age preferred full frequency range. Among listeners between 14 and 20, only 59 percent expressed an appreciation for the unrestricted tonal range in this classification of music.

"The listeners in the latter age group," Dr. Olson stated, "are probably influenced by listening to radios, phonographs and juke boxes rather than orchestras and are, therefore, conditioned to a restricted frequency range."



The 2½-watt transmitter used to broadcast to the student body of Syracuse University.

MONTHLY REVIEW

the Radio Technician

Radio Items of the Month

Smallest 3-way portable is claimed by Sentinel, who offer a 4 x 4 x 8-inch model. The little set is a regular 5-tube and its performance is comparable to that of larger radios, according to the manufacturer.

Radio life-saving is not all confined to the distress frequencies, says Arthur Magee, New Jersey commissioner of motor vehicles. The 15-minute broadcast series, *Highways to Safety*, released by NBC, coincided with the lowest fatal accident record for 14 years. The radio broadcast "has undoubtedly contributed materially to this record," says Mr. Magee.

David Sarnoff, president of the Radio Corporation of America, was elected president of the Army Signal Association at its recent Fort Monmouth convention.

Milk and beer are now being pasteurized by a continuous radio heating process. Milk treated electronically, says George Brown, RCA electronic heating authority, keeps longer than ordinary pasteurized milk.

Russia plans to put 28 new and powerful radio stations into operation by 1950, the Soviet Communications Minister reported last month. He announced that Russia is now broadcasting in 30 foreign languages, as well as 70 languages used by native inhabitants of the Soviet Union.

Overproduction of small table models and erratic parts production have been the cause of dealers' and manufacturers' greatest difficulties, delegates and visitors at the recent Radio Parts Show were told.

Estimates of FM receiver production for 1947 were revised downward last month by the RMA. Earlier estimates of 2,500,000 for the year were cut to "between a minimum of 1,800,000 and a maximum of 2,100,000 receivers."

Columbia's color television research is being "drastically curtailed" according to company officials. The company will concentrate its efforts for the time being on actuality broadcasts such as sports and special events.

Heavy water, used in atomic research, and so important a short time ago that military expeditions were organized to destroy places where it was prepared, can now be bought by research workers from the Atomic Energy Commission for \$15 an ounce—less than the price of high-class perfume.

GEORGE P. ADAIR resigned last month as chief engineer of the FCC, after an association with the Commission which goes back to 1931. He will open offices as a radio engineering consultant.

Accepting his resignation with regret, the FCC announced the appointment of George Sterling, wartime head of the Commission's radio intelligence division, as Mr. Adair's successor.

SIGNAL STORAGE used during the war by the Germans enabled them to transmit a dozen or more messages in a fraction of a second, the U. S. Department of Commerce reported last month.

Submarines in dangerous waters would surface and send all their messages almost instantaneously, cutting down the possibility of being intercepted and located by Allied search equipment. The signals were received, amplified and projected on the screen of a cathode-ray tube of such persistence that *the signals could be stored for three weeks, if necessary.* Thus the receiving operator could decode them at his convenience.

The cathode-ray tube beam in this equipment scans a plate covered with a layer of microscopic quartz particles embedded in a photoelectric base. The particles of quartz hold a charge which varies with the intensity of the scanning beam. To transcribe the stored record, a beam of "black light" (either infra-red or ultra-violet, to avoid visible interference) is directed at the photoelectric plate, each point of which emits electrons in proportion to the charge at that point.

An electromagnetic lens focuses the streams of electrons on a fluorescent screen. The screen produces a visible image, which will last for 15 minutes, provided the plate continues to receive ultra-violet or infra-red light. However, the image can be wiped off the screen at any time by turning the light off and scanning the plate with an electron beam of uniform intensity.

PRICE CUTS on radio receivers have been announced by two leading companies. Emerson has announced reductions ranging from \$3 to \$20 on 9 table radio and radio-phonograph combinations. Admiral has slashed prices from 20 to 25 percent on its new 1947 line of receivers.

The trend was also noted by Majestic Brands, Inc., in a message to dealers which assured them that they would be rebated should the prices be reduced on any Majestic models authorized or established by the company or by Majestic Radio and Television Corporation.

In other quarters denials that radio prices are headed lower were heard, though it is generally admitted that prices may fall on the present stock of small table radios, which were produced in large quantities in 1946. Console models are largely unaffected by the price cuts, which have hit most directly on table and portable models.

MAJOR GENERAL H. C. INGLES, who served as Chief Signal Officer of the United States Army from July, 1943, to March, 1947, has been elected President and a Director of RCA Institutes, Inc., it was announced last month by David Sarnoff, President of the Radio Corporation of America.

As Chief Signal Officer, General Ingles was responsible for the Army's world-wide communication system, the enormous supply program of communication and electronic equipment for the Army, as well as the Signal Corps' research and development program.

His achievements in these fields of military activity are revealed in the citation accompanying the award of the Oak Leaf Cluster.



The citation reads, in part:

"Technological advancements made under his direction included the application of communications equipment in the field of psychological warfare, the development of radar to a degree which made it one of the most formidable of weapons, the use of radio relay systems for bridging inaccessible terrain, the use of panoramic reception for visual monitoring over wide frequency spectrums, the adoption and extensive use of teletypewriter and radiophoto transmission equipment and the use of highly secret cryptographic systems."

PRODUCTION of FM-AM receivers rose notably in the first part of the second quarter of 1947, the Radio Manufacturers stated last month.

The April output of FM-AM receivers was 47 percent over that of March, and production of all types of receivers in April was higher than during the first quarter of the year.

Estimated April production of all types of receivers by Association members was 1,548,540, compared to 1,337,269 in March. Total for the 5 weeks from March 31 to May 2 was 1,759,723, the highest 5-week production in all the history of radio.

Television receiver production for April was 7,886, an increase of 1,247 over the figures for March.

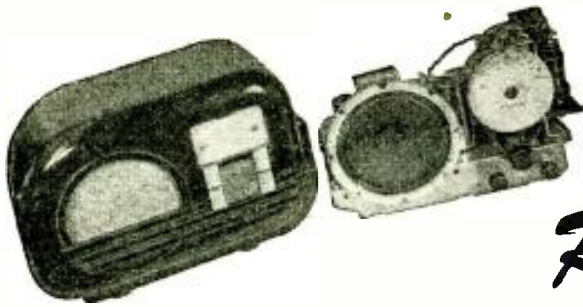

This receiver embodies a new and rarely-used principle in its method of detection.

Reflexed Four-tube

By W. T. CONNATSER

YOU will enjoy building and be proud to own this 4-tube super-heterodyne a.c.-d.c. broadcast receiver. A minimum of other parts are necessary for its construction, and the total cost should not be too high. Or an existing set may be readily modified to include the excellent second detector feature of this set.

The set is built around the demodulator (second detector) circuit invented

of illustration, and the hookup and functions of the 7E7 and directly related components are explained in some detail.

Obviously the 6A8 converter, the 6K7 i.f. amplifier, and the beam-power amplifier and B-voltage rectifier may be replaced by any combination of tubes that will serve the purposes. As to the 7E7, it may be replaced by any triode or pentode with the necessary diodes. The inventor of this detector circuit expresses a preference for a medium-mu triode of the 6SR7 type.

coil or a loop may be of use instead.

The oscillator coil L2 is standard for the 6A8 type tube, and is for 456 kc.

The padding condenser C4 generally will be about 350 μ f for a 456 kc i.f. It is best to use an adjustable padding condenser. The tuning condenser C2 is a 360- μ f, 2-gang unit.

The hookup of the 32L7 beam-power amplifier and B-voltage rectifier is conventional for this tube.

Negative bias for the 6A8, 6K7, and 7E7 tubes is obtained from the oscillator grid of the 6A8 tube (pin 5). This negative voltage is dropped through R2 to bias the 7E7 tube, and is further dropped through R4 to the a.v.c. circuit to bias the 6A8 and 6K7 tubes.

The a.v.c. circuit is made up of R7 and R8, and C6 and C7, and is of superior type. This network maintains volume level as between stations of varying power, and is designed to filter out all pulsating currents that might prevent good reception. Furthermore, it effectively isolates the 6A8 and 6K7 tubes from the 7E7 tube.

The resistors R10 and R11 in the plate and screen-grid circuits of the 7E7 tube, because of the low B-supply available in this set, must be the lowest values that will not short-circuit the audio signal or adversely affect the tonal quality of reception when the reflex feature of the set is used. When no reflex is to be used at all, then the plate of the 7E7 tube is connected directly to the B-plus supply and by-passed to ground by a large condenser, and an appropriate resistor and by-pass con-

(Continued on page 66)

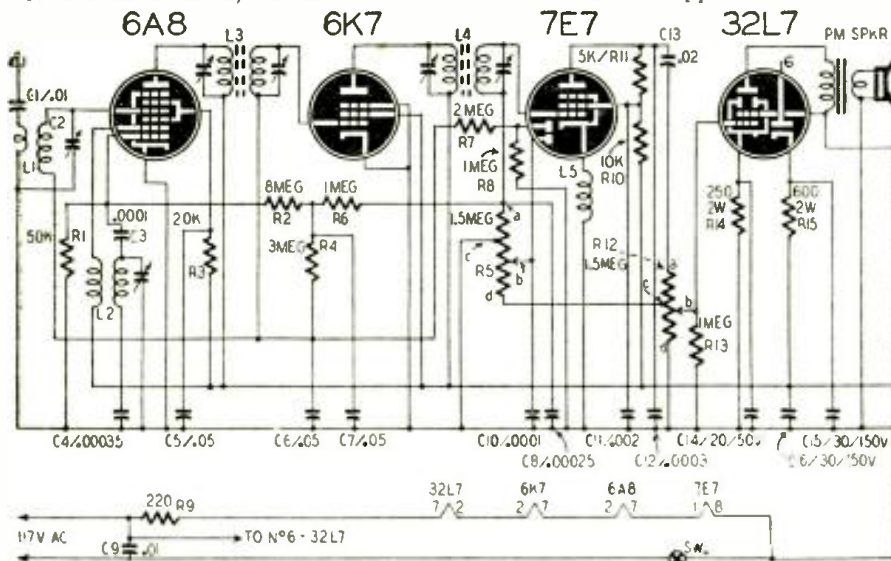

The queer-looking detector circuit is explained by the coil L5.

by Frederick C. Everett (Pat. 2,361,616). This patent was reviewed by RADIO-CRAFT in the March, 1945, issue.

A complete set is here shown by way

of illustration, and the hookup and functions of the 7E7 and directly related components are explained in some detail. Obviously the 6A8 converter, the 6K7 i.f. amplifier, and the beam-power amplifier and B-voltage rectifier may be replaced by any combination of tubes that will serve the purposes. As to the 7E7, it may be replaced by any triode or pentode with the necessary diodes. The inventor of this detector circuit expresses a preference for a medium-mu triode of the 6SR7 type.

In the set here shown a high-impedance-primary antenna coil L1 is used, which permits the use of almost any length of antenna. Of course a single

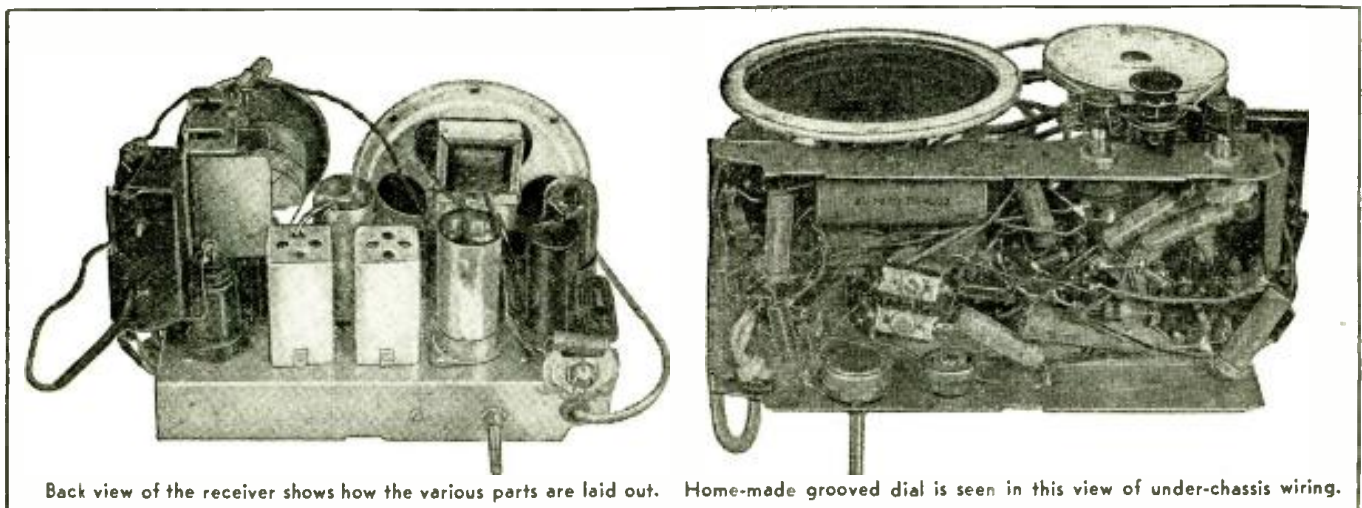

Back view of the receiver shows how the various parts are laid out. Home-made grooved dial is seen in this view of under-chassis wiring.

RADIO CONTROL is coming sharply into the public eye. We hear much in the press of radio-controlled airplanes, as at Bikini. Directed by radio at a distance of several miles, they were able to penetrate the radioactive clouds created by the explosion and furnish important photographs of yet little-known phenomena.

The factories in which the atom bombs were built also used electronic remote controls which permitted operating dangerously radioactive equipment from a distance of several hundred meters.

During the war of 1939-1945, remote-controlled radio tanks and planes appeared in action. Pocket tanks used by the Germans at Anzio served as mobile mines and moved at a speed of more than 15 miles per hour. Radio-controlled planes and rockets were used by both sides in the latter stages of the war.

Finally, the Americans developed jet-propelled aerial torpedoes. These were released from airplanes, whose occupants could direct them to their target by modifying their trajectory with radio-controlled rudders.

Already in France certain laboratories are studying pilot models of remote-controlled vehicles and planes, and several amateurs have constructed models of boats, gliders, and automobiles which are controlled by radio.

A photograph shows a radio-guided automobile built by a 28-year-old French constructor, M. Roveyaz. Of reduced dimensions, it can be driven in any desired direction, at a speed which can be controlled remotely by the operator with the radio transmitter shown in the photo on page 74.

This development is all the more interesting because of the small size of the model. The reader will understand that the difficulties increase in inverse ratio to the size and weight. With such an automobile, weighing 5½ pounds and measuring 20 inches, it is hardly possible to send it out to the country to forage for food, while the owner, defying the thunders of the Minister of Supplies, remains comfortably seated in an armchair, and controls the speed and direction of his machine by pushing several buttons on the small box! But anything that is possible for a model of reduced dimensions is an assured fact for an automobile of normal dimensions, except of course the question of visibility. This makes it necessary to perform all maneuvers within the field of vision (up to 600 meters in our case) and often makes it preferable to employ a model of a ship maneuvering on a large body of water (or the edge of the sea) or a remote-controlled plane. There can be no question of installing a television on a small model.

Construction of the model

Before studying M. Roveyaz' model, let us remember the exact definition of remote control. It is putting into operation at a distance, at the will of the operator, electrical apparatus, without having recourse to wire.

The transmitter works on a wave

FRENCH RADIO-MODEL AUTO

By SIMON COUDRIER

length between 4 and 6 meters. Experience has shown that medium power (between 15 and 30 watts) is sufficient for reliable radio control up to a distance of at least two miles.

The oscillator section is of the classic type. Fig. 1 is the schematic. It uses two 6L6's, as oscillator and power amplifier, the transformer TR permitting connection of a modulator. Construction of this equipment presents no difficulty, but it demands material of the highest quality.

Another system employed by M. Roveyaz consists in using a 1-tube transmitter, operating on different frequencies, spaced several centimeters apart, and modulated by applying an audio-frequency signal to the grid. Each wave length then corresponds to the control of one operation.

The skilled constructor no doubt will have his own ideas as to the coils and capacitors, but the following may serve as a guide.

L1—6 turns No. 14 wire on 1-inch

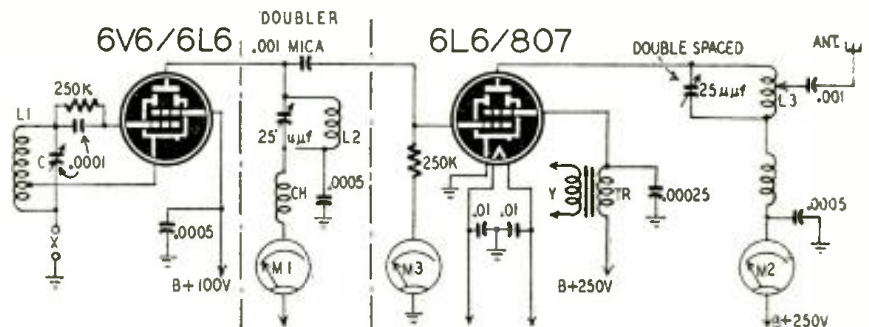
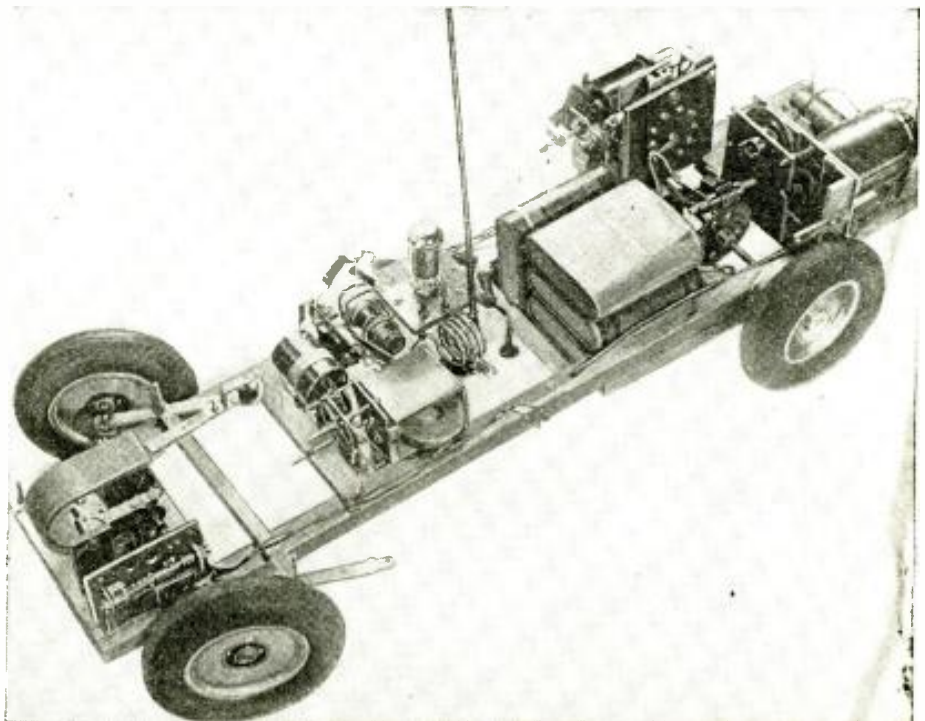

Fig. 1—Transmitter used for control by varying signal length. Modulator connects at YY.

Control is effected at X by a system which, by contactor, key, or automatic telephone dial, gives a signal whose duration is more or less variable, depending on the operation to be performed.

form spaced to occupy ¾ inch. Cathode tap 1¼ turns from ground end.

L2—5 turns No. 14 wire on 1-inch form spaced to occupy 1¼ inch. Air-wound. (Continued on page 74)



Model automobile chassis used by M. Roveyaz, with the receiver which controls its operation.

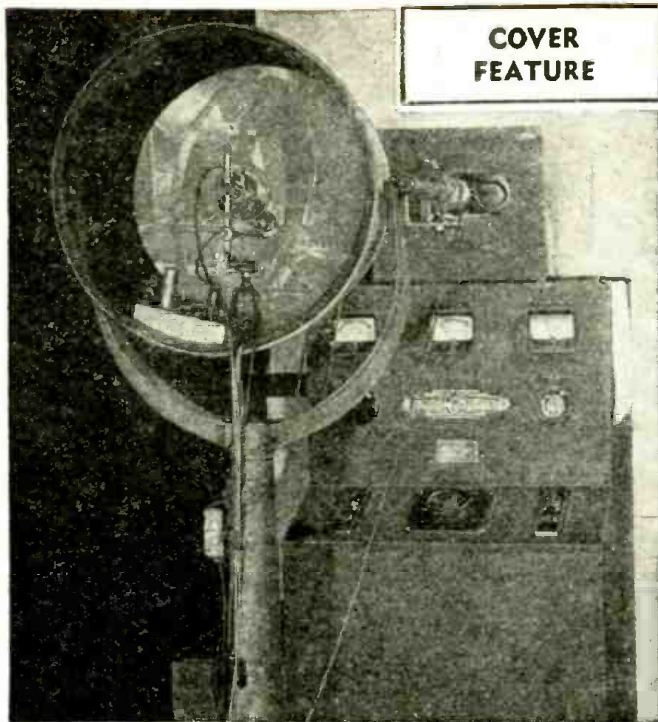

COVER
FEATURE

Television Over A Light Beam

Light offers several advantages for
directional television and radio relays

The transmitting end. Equipment is mounted in a parabolic reflector, like that of the receiving unit, which is shown on the cover.

THE history of radio communication is a history of ever-higher communication frequencies. The recently announced color television service, for instance, will work in a band near 500 megacycles. But the apparatus pictured on our cover operates at 600 million megacycles! Yes, the only possible explanation is, of course, that these ultra-frequency waves are ordinary light!

Light offers several advantages for short-distance relaying of television programs, and possibly for other forms of dispersing information ordinarily carried by radio. Among the most important for television is the elimination of "ghosts," which are one of the worst bugbears at lower frequencies. Another advantage is privacy. Because of the extremely directional qualities of a ray of light, the beam can be focused exactly on the receiving station, with no possibility of undetected interception. This would adapt it especially to such applications as the transmission of television programs from a central light transmitter to local motion picture theaters for showing of pictures on ordinary theater screens. This even could be done in such complete secrecy that the program could not be snatched off the air by unauthorized receivers.

Although first demonstrated last November before the American Institute of Electrical Engineers and more recently before the Federal Communications Commission, photovision as a basic idea harks back to 1934 when Patent No. 1,984,673 was issued to Allen B. DuMont of Upper Montclair, N. J. That invention relates to electro-optical systems and particularly to a direct-vision television system quite independent of the usual electrical transmission channels. A feature of the invention is the employment of a high-powered light source which is capable of being viewed over very long distances. The light

source is modulated in accordance with television signals. Originally Dr. DuMont proposed to use a high-powered light source such as a water-cooled neon lamp, or a lamp such as used for aerial beacons, and which are visible over distances of 15 to 25 miles.

With the advent of electronic scanning, Dr. DuMont revised his invention to transmit electrical signal-element equivalents in the modulated light beam. Such signal elements now comprise not only the modulation for lights and shadows of the image, but also the synchronizing pulses for the positioning of the pictorial lights and shadows on the usual cathode-ray screen, with the full wealth of detail which electronic scanning provides.

Special cathode-ray tube

Since the practicality of *photovision* depends on a powerful yet highly responsive light source, it was necessary to develop an entirely new type of cathode-ray tube with a fixed, intensity-modulated beam that can be varied up to 5,000,000 times per second. In the earlier demonstration equipment, this tube, which is shown at right, produces a dull, light-green spot less than 1 inch in diameter on the fluorescent screen. It seems uncanny that such a source of illumination can transmit television pictures over considerable distances despite full daylight.

The phosphor used for the screen is one of the new materials under development, with a delay time less than one-tenth that of calcium tungstate (P5), heretofore the fastest standard phosphor. The screen has an efficiency approximately 60 percent that of the highly brilliant P1 phosphor. However, other phosphors capable of producing far greater intensities—yet with the necessary extreme response speed—are under development in the DuMont Labora-

tories for the full commercialization of photovision. In addition to greatly increased illumination levels for the transmitter light source, more refined optical systems such as critical reflectors or veritable searchlights, as well as focusing lenses, are now under consideration.

Receiving equipment

The receiving end of photovision is a simple photoelectric cell on which the intercepted light beam is focused, by suitable reflectors or lenses or mirrors. This cell converts the modulated light beam into corresponding electrical values which reproduce the transmitted image on the usual cathode-ray tube screen. Thus the receiving circuit is vastly simplified by the elimination of all r.f. and i.f. stages because the output of the photomultiplier cell or tube is sufficient to modulate a picture tube directly.

The photocell is shown in its position inside the large parabolic mirror housing. The strange distorted reflection in



The special cathode-ray transmitting tube.

the mirror will be seen to be the image of the cell's shield can, with its corrugated top and lens opening on the inner side.

The equipment shown on the cover and in the photographs represents a workshop setup, and the informal position of the photocell is due to the fact that it is most convenient not to have a permanent mounting during experimental work. Amplifier equipment, mounted for convenience in the transmitting parabola housing, of course would be mounted below or behind the parabola in permanent equipment.

Meanwhile the sound component of
(Continued on page 69)

NARROW-BAND FM FOR HAM RADIOS

By NORMAN L. CHALFIN

MANY amateur operators are now transmitting narrow-band FM. These signals are received on a standard AM communications receiver by "side-slope" detection. The receiver is detuned slightly, so that the frequency modulation results in changes in the received amplitude of signal. A positive frequency shift causes a rise in amplitude and a negative frequency shift causes a fall. This pickup method does not permit making a center-frequency adjustment or measurement. To tune the signal "on the nose" a discriminator is required. Discriminators can be built into or attached externally to standard communications receivers. For the more ambitious operator these can be wired in with a change-over switch.

The discriminator with crystals is shown in Fig. 2. The major advantage of the crystals is that they may be wired right into the transformer can along with all other components as shown in the photograph.



Attachment to receiver

One of these discriminator units may be wired into a commercial receiver in one of several ways. The unit may be wired to a capacitor coupled to the plate of the i.f. amplifier tube just preceding the detector as shown in Fig. 2. A double-pole, double-throw switch is installed, with the arm connected to the audio input so that it can be switched from the AM to the FM detector outputs, as shown in Fig. 3. The AM detector wiring should be left intact so that the a.v.c. is retained. The second pole of the switch can be used to ground the cathode of the last i.f. tube. This will give some limiter action. Also some limiter action was obtained with the switching circuit of Fig. 3 on a commercial receiver when the last i.f. amplifier tube was changed from a remote cutoff type to one with a sharp cutoff. The replacement for a 6SK7 would be a 6SJ7. For the 6SG7 a 6SH7 may be substituted. Any of the above changes will

tion will vary with the sets into which they may be connected.

Tuning indicator

A center-frequency indicator can be connected to the detector system, as shown in Fig. 2. This would be a zero-center meter with about 100 or 200 microamperes on either side. When the carrier center frequency is tuned to the intermediate frequency the meter indicates zero. The limiting resistor is inserted to prevent banging the sides of the meter with high-level signals.

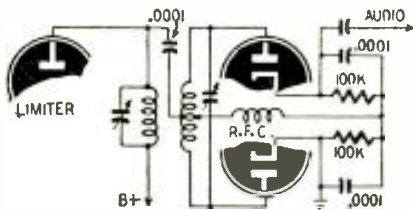

Fig. 1—Standard Foster-Seeley discriminator.

The circuit diagram of a standard Foster-Seeley discriminator for FM detection is shown in Fig. 1. It can be made from a center-tapped-secondary i.f. transformer. Several of these full-wave detector i.f. transformers are on the market. In place of the duo-diode a pair of germanium crystal rectifiers may be used. The Sylvania 1N35 is a commercially available matched pair of crystals. These are quite expensive. Two 1N34's can be used as well and are available at lower cost. The 1N21 works equally well.

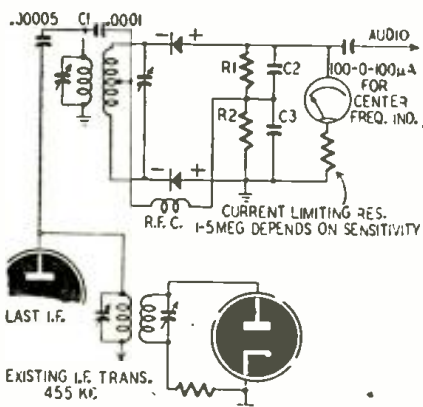

Fig. 2—Discriminator circuit with crystals.

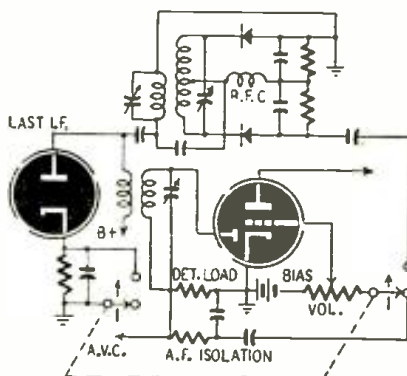

Fig. 3—Application to a standard receiver.

necessitate realigning the i.f. transformer to correct for the detuning caused by the new circuits. A more ambitious project would be to add a limiter stage and make the add-on unit a 2-tube affair. Or, if a crystal diode discriminator is used, there would be but one tube plus the diodes. A circuit arrangement for this is shown in Fig. 4. The arrangement is left to the ingenuity of the individual user, because the physical posi-

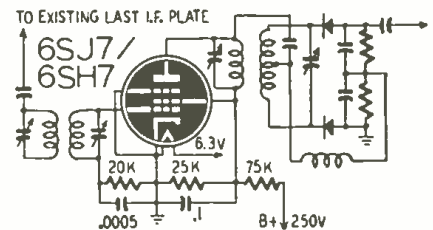

Fig. 4—Crystal discriminator plus limiter.

If a center-tapped i.f. transformer is not available a single-ended transformer may be used, as shown in the basic circuit of Fig. 5. This arrangement obtains its center-tapping through two resistances and application of the r.f. energy from the preceding tube plate to both ends of the secondary winding. This method of discriminator connection is employed where slug tuning is desired. The parts values, other than those shown in previous figures, appear in Fig. 6. Where a band-pass type of transformer is available, its tertiary

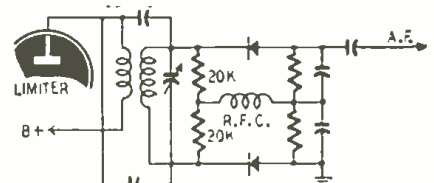

Fig. 5—How to use a single-ended secondary.

winding can be employed for the discriminator connection, as in Fig. 7.

(Continued on page 72)

COLOR

TELEVISION

By
H. W. SECOR

PART II

ONE of the most interesting color television devices recently demonstrated to the FCC is the *Trichroscope* picture tube. This tube, as Fig. 1 and Photo A show, has three electron guns built into it, one gun for each color to be reproduced. This tube may solve many problems for the simultaneous as well as the

Each color signal is injected into its respective gun in the new Du Mont tube. The three electron beams from the guns are focused on a special prismatic screen at the large end of the tube. The screen has myriads of small facets, shaped like pyramids, pressed on its inner surface. Each of the three sides of a pyramid is treated with a phosphor coating that glows with a different color (red, blue, or green) when the beam from its associated gun strikes it. When the various prismatic surfaces are illuminated by the modulated electron beams, a single image in natural color results. Pictures of great brilliance and contrast are produced by this tube, says Dr. Du Mont.

A unique method of producing color in movies from black and white images (on positive film) was recently demonstrated before the FCC in Washington by the inventor of the system, Richard Thomas. Its adaptation to television has not been demonstrated to date.

As Fig. 2-a shows, three black-and-white images are printed on a standard movie film, each image be-

ing graded for *color tone* by passing it through accurately balanced, red, blue, and green filters. The three images in each frame are picked up by a Thomas-

color *optical color analyzer* unit as shown. For producing color movies, this lens and filter unit restores color to the three images and blends them into a *single* color image, which is projected onto the movie screen.

The optical color analyzer unit comprises a series of lenses, prisms, and color filters, which split the image into three new black-and-white images, corresponding in color value to red, blue, and green. A single lens in the optical color analyzer picks up the image or scene and splits it into three color tone images, which emerge from the unit through three separate lenses, as the diagram shows. See photo B.

At the projection end the action is reversed. The position of the color filter unit is such that the three color tone images picked up are resolved by colored filters into one image in full restored color. This image is projected onto a screen.

In its proposed adaptation to television, the optical color filter unit breaks up the image into three color images—red, blue, and green. These three color images are projected onto the mosaic screen (photoelectric) of an

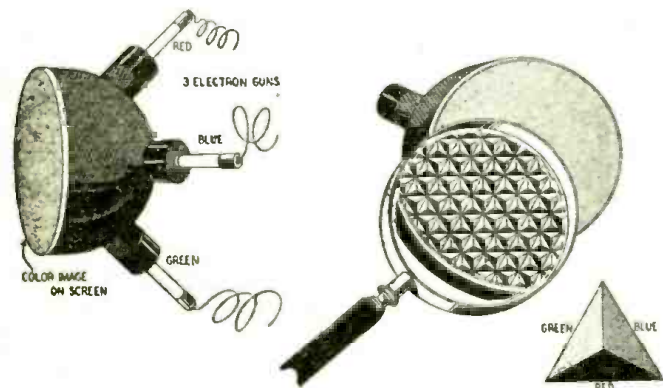

Fig. 1—The Trichroscope. Magnified section is interior of screen.

sequential devotees. For one thing it does away with the fussy adjusting and focusing of three separate cathode-ray tubes.

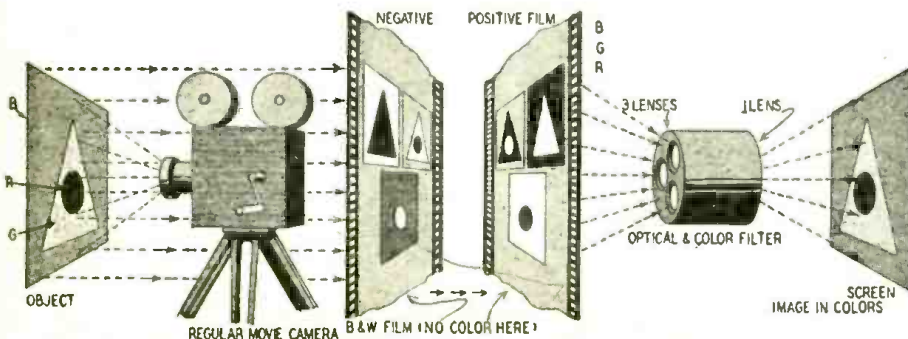

Fig. 2-a—The Thomascolor process, as applied to moving pictures.

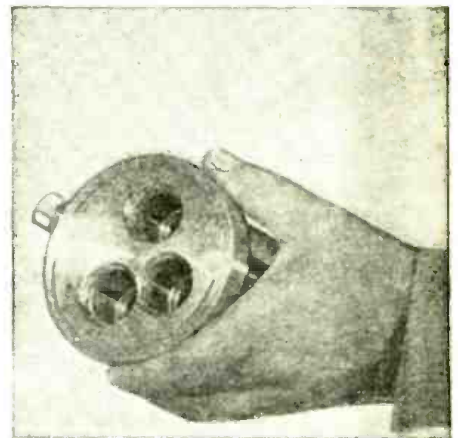

Photo B—The Thomas optical color analyzer.

orthicon tube (See Fig. 2-b). Here the electron scanning beam within the tube scans the three images as *one* picture and sends the resulting signals (or modulated current) to the television transmitter.

The picture is transmitted the same as any ordinary black-and-white television image. At the receiver a kinescope tube reconstructs the image (really three color tone or monochrome images; they have no color yet). A second Thomascolor optical and color analyzer unit (*in reverse*) is placed in front of the kinescope screen. As the three images corresponding to red, blue, and green are passed through the analyzer, color filters restore color to each. A single color image emerges from the color unit and is projected onto the screen.

This system should be particularly well adapted to the simultaneous method of television. As the three separation images are spatially identical both in film and on the orthicon tube, they can be scanned as one, permitting transmission on *one* carrier. This means a great saving in the frequency band width required and merits the close study of television engineers.

It should be noted that one of the Thomascolor features is the fact that a movie (in black and white) can be taken of fires and other news events (which could not be approached by cumbersome television trucks). After rapid development of the film, it can be rushed to a television station and broadcast.

Sleeper color system

Two patents have been issued to George E. Sleeper (Nos. 2,389,645 and 2,389,646) on a simplified system of color television. Fig. 3 shows the principle of the Sleeper system, which employs black and white transmission up until the time the image is finally thrown onto the receiver screen. This system has not been demonstrated, to our knowledge.

The object is picked up by the *quadchromatic* lens, which projects four images of different color onto the photoelectric screen in the camera tube. These images are scanned in a group as *one* picture, in the same manner as a black-and-white image. The picture (with its four color tone components) is transmitted as *ONE* black-and-white image, thus requiring but *one* carrier.

At the receiver a single cathode-ray tube reproduces in *black and white* (with graduated grays, whites, and blacks—tones corresponding to the four respective color values) four separate images, similar to those observed in the camera tube at the transmitter. These images at the receiver lack color so far, but they do possess the correct detail and intensities corresponding to the four colors. Color is now restored to each image (red, blue, yellow, and green) by collecting the images through a color filter and lens system. This unit is arranged in *reverse* order to the one at the transmitter, and projects the four blended color images onto the screen as a single image in full color.

The quadchromatic color filter unit contains lenses for picking up the images (or image, depending upon which function it is to perform—i.e., convert one image into four or the reverse), plus suitable prisms and color filters, as shown in Fig. 4. A simplified sketch of

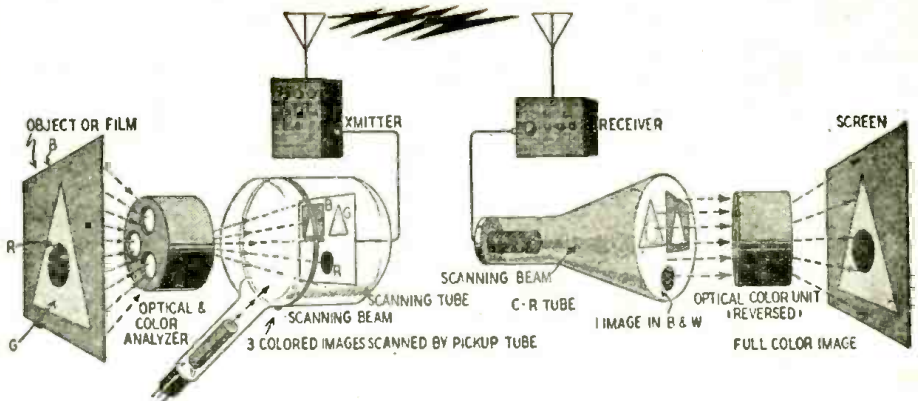

Fig. 2-b—How the Thomascolor process is applied to transmission of television signals.

such an optical system, using four separate lenses and four color filters, Fig. 5, will aid in making the process clearer. As in the Thomas color system, no color is actually transmitted, only the shaded or toned images corresponding to each color.

video band width. As Dr. Goldmark points out, the visual acuity or perception of detail is fairly well saturated at 525 lines. At least 50 percent more lines would have to be added to realize a noticeable improvement in definition. If 750 lines are used, as some

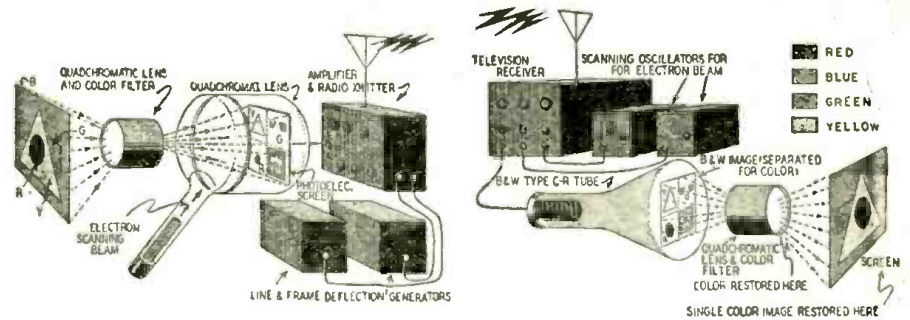

Fig. 3—The proposed Sleeper color television system separates and re-unites four colors.

How the systems compare

Considerable criticism has been leveled at the mechanical (revolving) color filter used in the sequential apparatus. Dr. Goldmark in his report to the FCC illustrates and describes a full electronic sequential system which employs no mechanical color filters.

The 525-line standard proposed in the CBS report to the FCC has been attacked by some experts, who advocate a greater line-age. Here is some interesting data on this controversial phase of color television.

The 525-line image approaches 16-mm movie performance, with regard to the resolution or detail of the image. A noticeable increase in definition is obtainable only at the expense of appreciably greater

advocate, the necessary band width is doubled and each station's channel will be 27 mc wide. The number of channels available in the high-frequency television band will be reduced to 16. If 750 lines and 60 color frames per second are used instead of 48, there will be required a video band width of 25 mc and a chan-

(Continued on page 59)

Photo A—Typical Trichroscope in the experimental laboratory. Card board models of the inside screen surface are to be seen nearby.

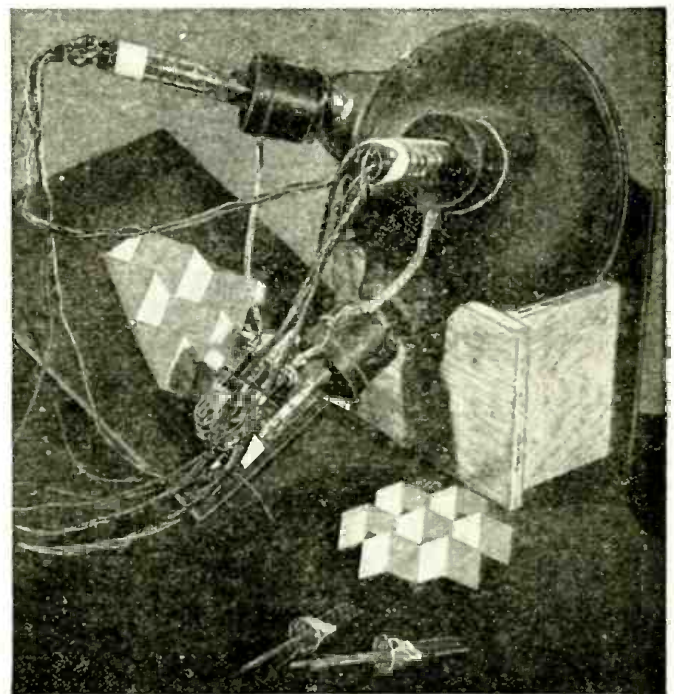

An Electronic Photometer

Some interesting information on photometry is also included in this article.

By J. G. REED

LORD KELVIN very aptly stated, when it is possible to measure a quantity in any experiment, it can be stated safely that there is an understanding of the problem. Photometry is a science in which the subject matter, light, appears at first sight to be an intangible something as elusive as the will-o'-the-wisp, and not likely to yield easily to quantitative measurement. Simple oil-spot photometers are very useful in comparing light intensities, and it was such an elementary device, intended for the measurement of light delivered by a photographic enlarger, that first received the author's attention. A series of developmental experiments culminated in the production of the *phototube photometer* described in this article.

With this knowledge it is an easy matter to make a simple oil-spot photometer that will make photo enlargement a much easier process. While not eliminating experience and empirical judgment, work will be placed on Kelvin's truly scientific basis of measurement of a factor—light—which heretofore has been a photographic ingredient over which writers have skipped in haste.

Take a piece of good drawing paper, and with a pin dipped in light machine oil, place a spot on the paper. This spot looks darker than the surrounding paper if light is on the same side as the observer, and changes to a bright spot if the light source is on the opposite side. This is because the treated paper is relatively transparent at this spot. In the first instance less light is reflected, and in the second, more is transmitted by the spot than by the surrounding paper.

Mount the photometer disc on a simple stand—or for a preliminary test it may be held in the hand—and with a table lamp on either side, move the disc back and forth. With two lamps of equal candlepower, and the disc not central between them, if the observer is on the side nearest lamp A of Fig. 1 the oil spot will appear as a dark patch. If the observer's position is changed to the side of lamp B the oil spot will be bright. Now if the photometer disc is slowly moved away from lamp A there will be a critical point where the transmission of light through the oil spot from one lamp exactly balances that lost by non-reflection of the other light, and the oil spot will disappear. Depending on the relative opaqueness and transparency of the untreated and treated paper, the point of balance will be quite marked.

If a small housing is put at the rear of the photometer disc, and lamp B is

replaced by a radio dial lamp or clear Christmas-tree light controlled by a variable resistor, we have the basis of a simple photometer.

With precautions taken to counteract the color change of the spot as the brilliancy of the lamp is varied, a very use-

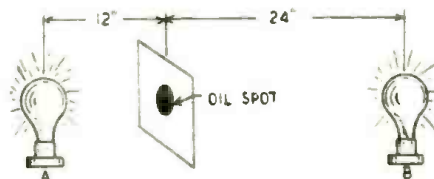

Fig. 1—Principle of the oil-spot photometer.

ful darkroom instrument may be constructed. Fig. 2 is a suggested construction for this simple photometer. Dimensions may be varied to suit available material.

For long life and constancy of calibration the photometer lamp should be underrun. If a 6-volt, 3 candlepower auto lamp is used, the maximum voltage should not exceed 5 volts, while for the standard 14-volt Christmas-tree light, 10 volts will be found sufficient.

A synthetic oil spot

The detailed drawing, Fig. 3, indicates the composition of the translucent area, which in a permanent instrument must be something more substantial than an oil spot. Use a small square of

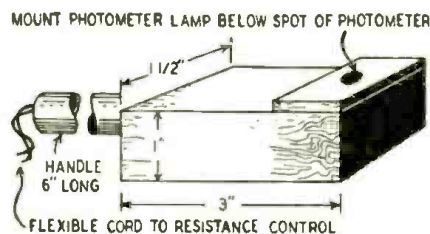

Fig. 2—Practical type of optical photometer.

photographic ground glass for the cover glass. Immediately below have a layer of thin white card or heavy typewriter paper. The paper should have a hole in it about one-eighth of an inch in diameter. Below that place a layer of green-blue tinted cellophane. This tinting is chosen for two reasons; one to neutralize the reddish light from the lamp when at low brilliancy, the other to provide a light to which the eye has maximum sensitivity at low illumination levels. Have the hole through which the light from the lamp passes about five-sixteenths of an inch in diameter so that it will form a halo around the central light spot through the white typewriter paper. This will be found to im-

prove the balance of the spot to reflected and transmitted light conditions.

Cement the combination at the edges and to the body of the photometer with a light brushing of model airplane dope or coil cement, clamping it until dry to make a firm job.

The external control resistor should have a value about twice that of the hot resistance of the lamp, and should be wirewound. For a 6-volt, 3-watt lamp the resistor should have a value of 24 ohms approximately. One of the old-style 30-ohm filament control resistors as used in battery receivers will be found just right.

Having determined experimentally an acceptable exposure time, future exposures are simplified to a procedure in which the diaphragm of the enlarger lens is controlled to give just that light necessary to balance the photometer spot at a standardized setting of the resistor.

An electronic photometer

Being one of those individuals who secure as much, if not more, pleasure in building gadgets for the darkroom as from the photographs produced, the problem of calibrating the simple photometer so that it would read the actual candlepower of the incident light gave the author considerable food for thought. The outcome was the construction of a *phototube photometer* that completely eclipsed the simple oil-spot instrument for which it was originally intended merely as a calibration adjunct. The circuit of this *de luxe* photometer is that given in Fig. 4. It consists of a 3-tube power unit plus a phototube exploring head, the latter being connected to its amplifier through a shielded flexible cable. Light falling on the sensitive surface of the phototube releases electrons which generate a negative potential on the grid of tube V1 of the electronic indicator. Reliance is not placed on any calibration of vacuum tubes as in a tube voltmeter. The two tubes operate merely as couplers to the balancing meter, which in turn serves as a portion of the voltmeter to measure

(Continued on page 60)

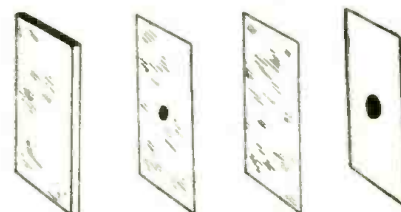
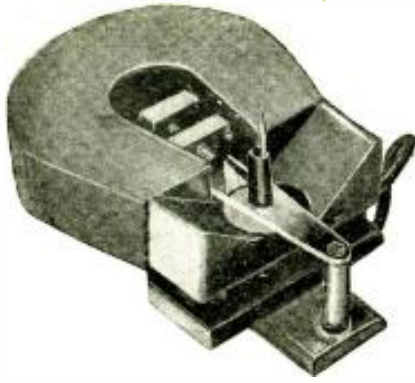

Fig. 3—How the synthetic oil-spot is made.



The skilled sound experimenter can construct this high-quality phonograph pickup himself, and obtain results comparable with those produced by commercial pickups.

Dynamic Pickup

By P. H. RUSSELL

THE moving-coil pickup, if properly designed and made, will take from the record exactly what is there. If the record is first-class and a true reproduction of what the recording microphone received, this pickup will pass to the amplifier a true electrical image of the groove on the record. If the record is poor and distorted, this pickup will show it as such. If the surfaces are bad, scratch will come through. It will reproduce exactly what is given to it. Oscillograph pictures of pure sine waves from constant-frequency records show pure sine wave output from its vibrating parts. It is, as nearly as possible, without character of its own, and is like a perfect mirror, reflecting truly the image presented to it.

The moving-coil pickup has only one very trifling weakness. Its output is low, therefore demanding great amplification.

The characteristics of a moving-coil pickup are essentially neutral—it has no characteristics. At its best, the frequency response is practically flat from 12,000 cycles down to 25 cycles per second. These frequencies are outside, above, and below any which are usually recorded. Its actual response runs down to 5 cycles per second, and up to 15,000 to 16,000. Thus it can take care of any improvements in recording which may be expected. It needs practically no damping. Indeed, for any but loud passages, damping can be omitted entirely. Hence the needle can float from side to side almost without force. These factors combine to enable this pickup to operate with as little as ¼ ounce weight on the record. It thus follows that record wear is

negligible, and surface noise is reduced to a minimum. Finally it is stable, not readily damaged, uncritical in the positioning of its parts, and the very light damping can be permanent, never needing attention or replacement. Needle changing becomes an occasional necessity instead of being a constant nuisance. Best of all, this pickup brings out all that there is in any record. Since using a moving coil, this writer has repeatedly heard from his records subtle effects and combinations of instruments that never before were heard when the finest crystal available was in use. The sounds heard can almost be described as stereophonic, as there is such a strong feeling of separation of the instruments. True stereophony cannot be had from a single speaker, but this is the nearest approach that can be conceived.

A pickup of this type can be made by any careful worker on any ordinarily equipped bench. The design shown gives results which not only are far ahead of any crystal so far heard, but compare well with the very fine (and expensive) pickup of commercial make which the writer has had in use for several months. It was made on the writer's home bench with only the ordinary very simple tools that every home mechanic possesses except for two. These two can be dispensed with, although they are so cheap and useful that they warrant spending the dollar or two they cost. They are, first, a set of 5 or 6 very small and fine needle files such as are used by jewelers, and second, a jeweler's saw

frame and a dozen or so of the fine wire saws to go with it. The cost of all will be \$1.50 to \$2.00 only, and these small files and saws have innumerable uses. (N.B. Mount the saws in the frame "pull-cut." Used "push-cut" they break as fast as you can put them in the frame.)

A warning here. Small tools cutting small work cut very fast. Work gently, and the material will yield. Work heavily, and it will tear and spoil.

Heart of the pickup

Figs. 1-a to 1-h show the first part to be made, the moving-coil former and chuck assembly. In working this out,



The completed pickup. Tone-arm weight is compensated by a spring.

care and the best accuracy you can apply are necessary. It is the heart of the instrument, and the more accurately and better balanced you make it, the better will be the results. It is made up of three pieces of metal lightly soldered together.

First take a piece of brass (shim stock from a garage is excellent) about 0.004-inch or 0.005-inch thick. ½-inch wide, and ⅞-inch or so long. Soften this with heat to remove all tendency to spring. Roll the brass around a piece of ¼-inch round rod, cutting the meeting ends and filing them with the flat needle file until they butt exactly. Work the

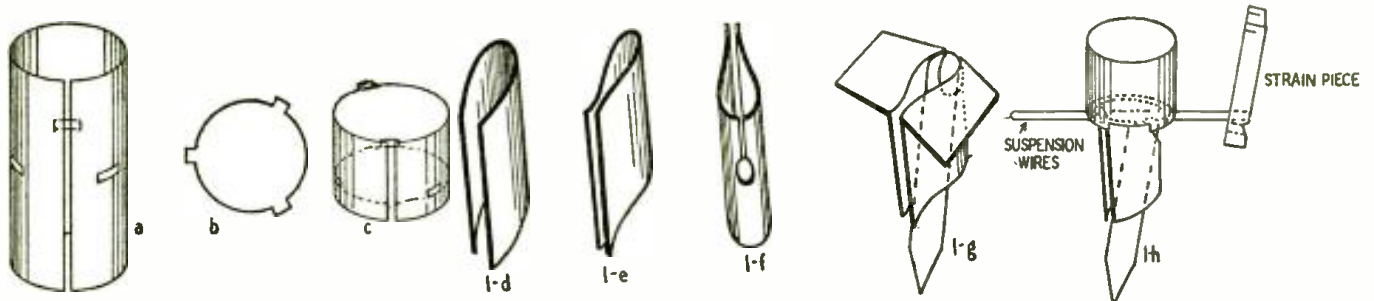

Fig. 1—Components of the moving element, shown in breakdown. Complete references and details of construction are given in the text.

brass into place with the pliers until a perfect cylinder results which fits the $\frac{3}{8}$ -inch rod exactly. Tie a piece of thread around the cylinder temporarily, and at equal intervals, at equal distances of $\frac{5}{32}$ -inch from one end, cut three very small slots through the wall as shown on Fig. 1-a. Use the rod on which you rolled the cylinder as a mandrel for this and for future operations when it is useful.

Take another piece of the same brass, softened as before, and well flattened. Cut a disc $\frac{1}{4}$ -inch in diameter to fit inside the cylinder you have made, and leave three lugs or ears, as shown in Fig. 1-b, which will correspond with the three slots you cut in the cylinder wall. With care partly unroll the cylinder, insert the disc, and roll and tie the cylinder again. Insert the mandrel and trim it up if necessary. Bend up the lugs until they are flush, remove the mandrel, and solder as lightly as you can, seeing that the solder runs well into the joints. Acid flux is best for this work, and a good hot soldering tip helps, too. Now replace the mandrel, setting it snugly against the diaphragm, or disc, you have just fixed, and trim the cylinder down to $\frac{5}{32}$ -inch on one side of the diaphragm and $\frac{1}{32}$ -inch on the other. This is shown in Fig. 1-c. The coil form is now complete, but the needle chuck must be attached to it. For this pickup we do not use the old-fashioned screw fastening. It is too heavy. The screw alone, apart from its mount, would weigh as much or more than the combined coil, chuck, and suspension. Instead we use a self-locking chuck. That shown was devised by the writer especially for this pickup.

Needle and chuck

Thin needles are lighter, and so are better. The movement is so light and free that heavy needles are a great disadvantage. The best alloy or chromium needles should be used. You may like a sapphire point better. It is very durable and, with the light weight of this pickup, very easy on records. So, if you decide on a sapphire, acquire one of the standard commercial needles with a round shank and get a jeweler or watchmaker to straighten it and cut it down on his lathe to $\frac{37}{1000}$ -inch thick and $\frac{3}{8}$ -inch to $\frac{7}{16}$ -inch long from point to the opposite end of the shank. A shoulder can be left near the point so that the setting of the jewel will not be disturbed.

Any needle will do, however, so long as you decide on the thickness of the needle you will use. This must be settled, since the very lightweight chuck to be used is built to take only needles of a specified thickness.

Having settled this point, take a piece of brass, or better, phosphor bronze (from an old switch for example, which is what the writer used) about 0.012-inch or 0.014-inch thick, $\frac{1}{2}$ -inch long, and wide enough to fold around the thickness of needle you have chosen, with a bit over for a "pinch." Select a piece of waste wire of the proper thickness and fold the bronze lengthwise

around the wire. Pinch the surplus in the vise. Take the round needle file and make an oval slot in the back, or folded part of the chuck so that one end of the slot is $\frac{1}{4}$ -inch from one end of the chuck. Cut a slit in the back from the slot to the other end of the chuck. These three steps are shown in Figs. 1-d to 1-f. Fold open *exactly evenly* the ends made by cutting the slot and the slit, making the bend at the slit end of the oval slot. Cut off these ends so that they will fit exactly into the $\frac{1}{32}$ -inch cup side of the former, exactly centering the chuck. Flatten the turned-down ends so that they face the diaphragm neatly. See Fig. 1-g. Cut tiny slits in the sides of the shallow end of the form below the diaphragm. Trim off the pinched metal. Then set the chuck in place in the form and turn down the metal where you cut the shallow side until the ears of the chuck are locked. Again using acid flux, solder the chuck in place. The appearance then will be somewhat as in Fig. 1-h, which shows the needle as it will sit in place and also the suspension wires which will be attached.

In mounting the chuck, arrange the ears with a slight bend so that when mounted the pinch side will make an angle of 5 to 7 degrees with the coil form. This simple chuck holds a needle thus: The needle enters the chuck freely. When the weight of the pickup rests on it, the needle rests on the diaphragm of the coil form, in the oval slot which was left, and against the pinch of the chuck, being lightly jammed so that no lateral movement of the needle in the chuck is possible. The drag of the record as it turns locks the needle firmly. Yet it can be slipped out easily for changing. The force of the magnet in the pickup keeps the needle from falling out of the chuck when it is removed from the record, and when it is replaced the weight of the pickup at once sets the needle back in the right place, which is the only place at which it can rest. Figs. 1-g and 1-h show the chuck with the needle as it will rest when in use. Fig. 1-h also shows the strain and suspension wires which will be discussed later.

Pole pieces and mountings

The next step will be to make the pole pieces. No dimensions can be given for these as they will depend on the magnet which will be used. Even the shape

shown in Fig. 2 may be varied, but that indicated suits very well the usual horseshoe magnet. The essential thing is a circular gap between the pole pieces in which the coil will be set finally, with room to vibrate in the magnetic field between the poles. The gap should be small enough so that as great a concen-

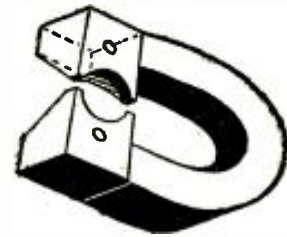
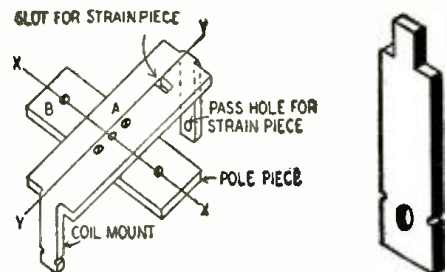

Fig. 2—Pole pieces should resemble these.

tration of magnetic lines of force as possible can be directed into the coil, and no larger than enough that the coil will not touch the pole pieces in vibrating. For our $\frac{1}{4}$ -inch form, $\frac{3}{8}$ -inch would be a trifle large. $\frac{5}{16}$ -inch does very well. Fig. 2 shows how they are made in the pickup designed here, but other patterns may be worked out. The faces of the pole pieces which meet the magnet should be ground flat on the whetstone so that close all-over contact is made. Neglect of this will result in loss of field strength. The inner faces of the pole pieces should be chamfered as shown so as to concentrate the lines of force in the gap.



Figs. 3 and 4—The mounting and strain piece.

The pole pieces now should be mounted. For this, cut a piece of $\frac{1}{16}$ -inch brass into appropriate size and shape to hold the pole pieces. Drill the mounting strip and drill and tap the pole pieces to correspond. Set in $\frac{1}{16}$ -inch or $\frac{3}{32}$ -inch spaces between the pole pieces and the mount. Figs. 3 and 5 will indicate the idea here.

Next will come the mount for the

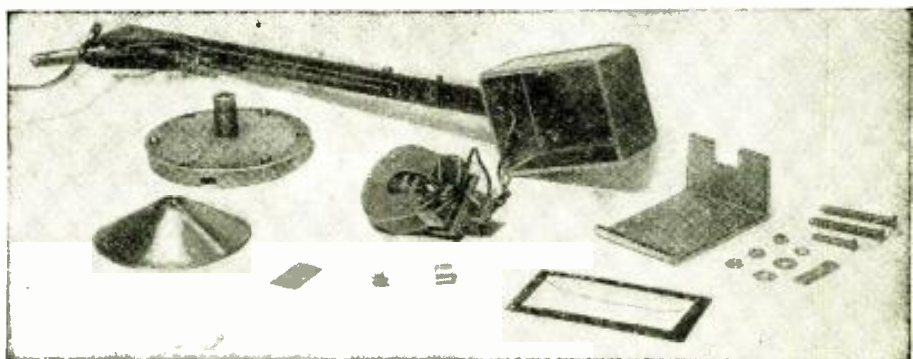

Exploded view of pickup. A piece of the metal ribbon is shown on bordered paper, foreground.

coil (A in Fig. 3). This will be another piece of 1/16-inch brass fastened centrally. It should be cut about 2 1/4-inch larger than the width of the pole pieces, leaving enough material for final trimming. Its exact length is not critical. It should be drilled with two holes and the pole piece mount (B in Fig. 3)

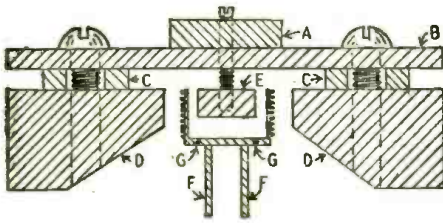

Fig. 5—Cross-section of completed assembly at line X-X. A—coil mount; B—pole piece mount; C-C—magnet spacers; D—pole pieces; E—magnetic core screw assembly; F—needle chuck and coil; G-G—Coil suspension wires.

drilled and tapped to correspond. Round-head screws should be used, and the holes in the coil mount should be about 1/16-inch large to allow for adjustment in case the coil, when finally mounted, is slightly off center. (Work in the home or small shop cannot be as accurate as that in a well-tooled machine shop.) Cut 3/8-inch from the center, toward one end, and bend the mount down at right angles. Cut the width of this turned down part down to 1/8-inch with the file or jeweler's saw. This turn down should be about 1/2-inch long. About 3/4-inch from the center turn down the other end and narrow only enough to permit it to clear the inner walls of the horseshoe magnet. This turn down should also be 1/2-inch long. In the top, and about 3/16-inch or so from the end just turned down, drill and file a rectangular slot 1/8-inch or so long, across the width of the coil mount, and a trifle wider than the thickness of the brass you are using.

Cut another piece of brass 3/16- or 1/4-inch wide, with a square-cut lug or projection on one end to fit loosely into the slot cut in the coil mount. This is shown in Fig. 4, the strain piece. Near the bottom of this strain piece drill and tap a hole for a small screw, and drill and file in a vertical direction a hole in the end of the coil mount on which the last work was done, as shown in Figs. 3 and 6, which show these parts clearly.

This work completes the mounts, except that for the coil itself. For this a loop of fine but strong wire is used. After a number of experiments, final settlement was made on a piece of a non-magnetic hairspring. A bent or broken hairspring should be obtainable from any watchmaker or repairer. Equally well would do the bronze wire used for the pin-springs in Yale locks. The choice of material does not matter so long as it is thin, nonmagnetic, and strong enough to take some tension without stretch.

Assembling the pickup

Mounting the coil needs care. First cut four tiny slits in the walls of the lower, shallow end of the form, just up

to the level of the diaphragm. These should be as nearly the size of the wire you are using as possible, and must be so cut that when the wire is laid in the slots it makes two parallel lines which are equidistant from, and parallel with, that diameter of the form on which lies the plane of the slope of the chuck. Figs. 1-h, 5 and 6 show how these wires are to be set.

Make a bend in the wire to fit around the end of the coil mount opposite the strain piece and bend the extreme tips of the ends of the wire so that they will fit around it when it is set about 1/8-inch from the coil mount. Solder securely to the strain piece and cut off any waste ends of wire. Slip the wire over the mount and tighten the strain piece gently, letting the wire find its place on the mount, parallel with its top side. Assemble with the pole piece mount with pole pieces in place. Slip the form into place, centering it in the gap in the pole pieces. Set the wire in the slots in the form. Slip some pieces of card between the form and the pole piece mount, just enough to hold the form against the wires. Then, see that all is secure and centered and solder the wires lightly in place in the slots. By this method of assembly in place, the desirable exact placing and centering of the coil can easily be arranged.

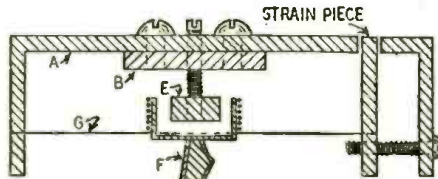

Fig. 6—Assembly cross-section at line Y-Y.

Disassemble the parts and with a sharp knife and fine file clean up the solder, removing all surplus to leave the form as light as possible. Gum a slip of cigarette paper around the form and wind on evenly 20 to 25 turns of the finest enamelled copper or aluminum wire you can obtain. The number of turns is not critical. Paint the wire with collodion (10 cents worth from the drugstore) or with a varnish made from a spot of Duco household cement and ether or acetone. Solder one end of the wire to the form itself, or to any part of the mount. This will be the low-voltage end of the coil. Leave the other end open for the moment.

From an iron rod or bolt 3/16-inch thick cut a cylinder 1/8-inch long. Drill and tap in the exact center for a small iron screw. Do not run the threads clear through. Take the corresponding screw and cut off its head. Drill and tap the pole piece mount and coil mount so that this hole is exactly centered over the middle of the coil form.

Attach the iron cylinder to the screw tightly (that is why the threads were not cut all through) and set it in place in the mount so that the cylinder will just fit inside the cup of the form with clearance all around and below. Fasten with a lock-nut above. This part is E in Figs. 5 and 6.

Attach to the mounts at any convenient place a slip of insulating material to which the high-voltage end of the coil can be attached.

Now everything should be ready for final assembly. To avoid spurious vibrations on loud passages, slight damping is necessary. For this purpose a very light grease is good. This can be prepared by mixing vaseline with machine oil so that the mixture will nearly but not quite—run. It is almost oil rather than grease when the texture is right—a sort of oily jelly. Fill the cup of the form with the mixture and spread it around the outside of the coil—enough to fill the space between the coil and the pole pieces. This damping will not deteriorate and will never need attention or replacement; but be sure that the mixture is not in the least stiff or the coil will not respond.

Attach the high voltage end of the coil, set the magnet against the pole pieces, and everything is ready for setting in a head case and tone arm. In assembling, tighten the coil mounting wires so that they are just taut and no more. Overstrain is needless; it may break the delicate wires and in any case puts unnecessary drag on the needle and record. When taut, put a speck of rosin on the screw at the strain piece and melt into the threads with a match held at the head end of the screw. The heat will run, melting the rosin, and lightly, but sufficiently, locking the strain piece. The case and arm can be worked out in any way that appeals to the maker, remembering that the pivoting in both directions must be very free. The final weight of 1/2-ounce or so on the record is so little that any binding will cause the needle to skip grooves.

In working out the tone arm, provide for a spring or weight counterbalance. The former is theoretically better, though not so easy to arrange. Fig. 7 shows one system of spring counterbalancing which works well.

The pickup head should be offset from the tone arm. Perfect tracking in a radial tone arm is not possible, but an offset angle of 23 degrees with a 10-inch
(Continued on page 62)

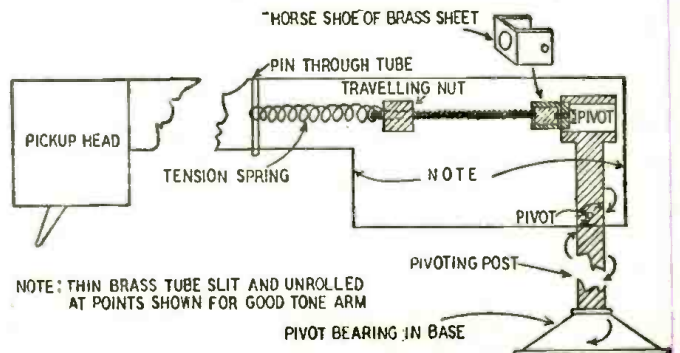
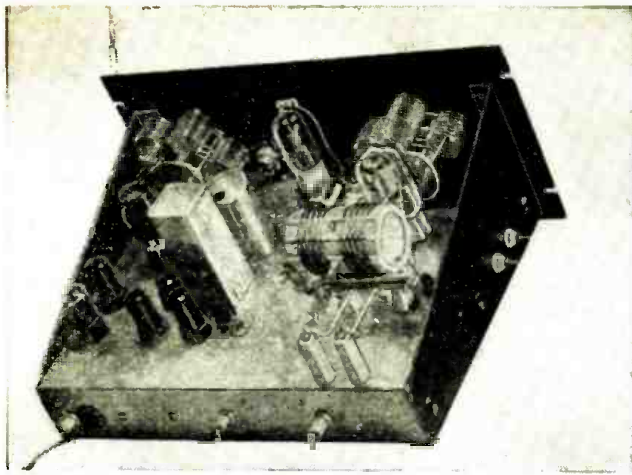
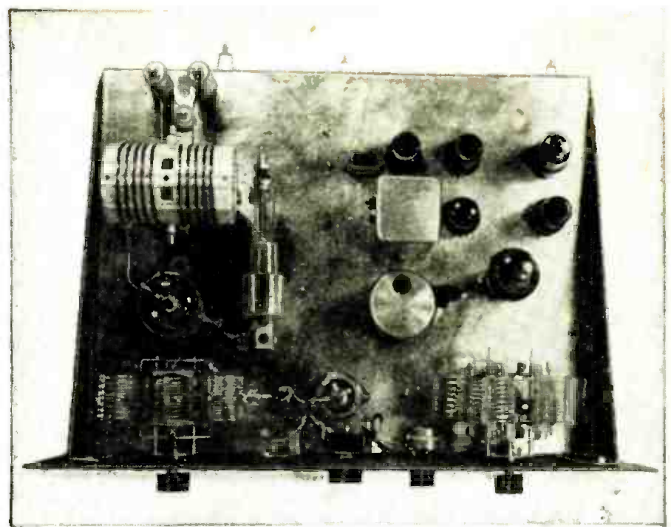

Fig. 7—A spring can be used as shown to counterbalance the head.



Rear and top views of modulator and oscillator sections. Tubes of the FM section shown in Fig. 1, are those nearest rear of chassis.



250-Watt FM-AM Transmitter

PART I--The FM Modulator and Stabilizer

By HARRY D. HOOTON, W3KPX

A 250-WATT amateur-band transmitter recently developed by the author is strictly post-war in its design and application. This transmitter has a medium-power, band-switching r.f. exciter and frequency multiplier stage using a Taylor TB-35 beam-power tetrode tube, and an HK-54 final r.f. amplifier. Either crystal or v.f.o. control may be used as desired, and there are provisions for either amplitude or frequency modulation.

The electrical circuit consists of a 6F6-G crystal-controlled or variable-frequency oscillator, a TB-35 buffer and frequency multiplier, and an HK-54 final r.f. amplifier. These will be dis-

cussed in Part II of this article. Shown in the schematic (Fig. 1) is a 6SN7-GT FM speech amplifier, a 6SJ7 reactance tube, a 6H6 discriminator rectifier, a 6SA7 mixer, and a 6C5 crystal oscillator. These tubes are a part of the FM circuit.

The 6SN7-GT, 6SJ7, 6H6, 6SA7, and 6C5 tubes and their associated circuits are used for FM only. The 6SN7-GT is a dual-triode and is used as a 2-stage resistance-capacitance-coupled a.f. amplifier. The 250,000-ohm potentiometer in the grid circuit of the 6SN7-GT second section should be referred to as a *deviation* control rather than a *gain* control. The adjustment of this potentiometer determines the FM band width

transmitted. Its indicating scale should be calibrated in terms of the deviation in kilocycles from the main carrier or unmodulated resting frequency.

The 6SJ7 is a reactance-tube modulator. In the circuit arrangement shown in Fig. 1, the 6SJ7 plate-cathode circuit is connected across the 6F6-G FM oscillator grid tank circuit. The plate of the 6SJ7 is connected, through a 0.005- μ f coupling condenser, to the hot side of the 6F6-G grid coil. Another 0.005- μ f coupling condenser transfers r.f. from the hot side of the oscillator tank coil through a 50,000-ohm resistor to the control grid of the 6SJ7. A current then flows through the 50,000-ohm resistor and the capacitor formed by the input capacitance and stray capacitance of the 6SJ7 grid circuit, producing a voltage drop across the capacitor. The value of the resistor is such that the r.f. volt-

(Continued on page 68)

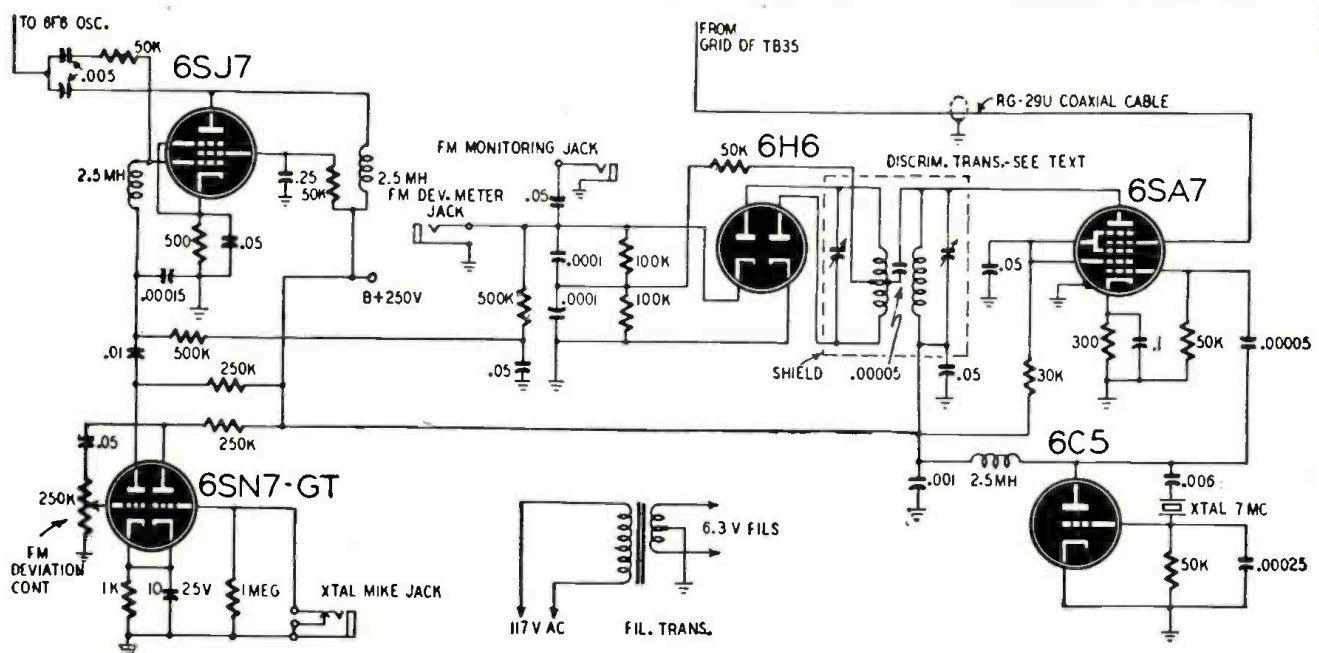
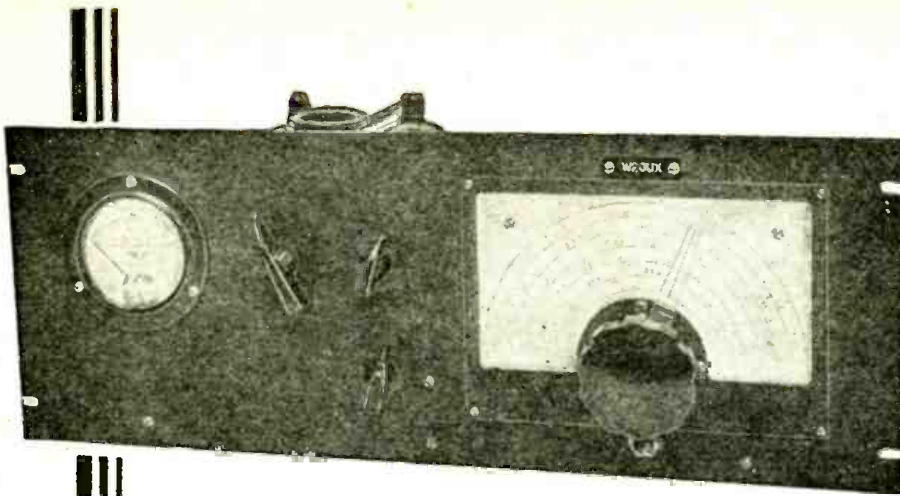

Fig. 1—The modulator. Note that the 6SA7 is wrongly drawn as a 6A7. Suppressor should be to cathode and TB-35 lead to pin No. 8. RADIO-CRAFT for JULY, 1947



V.F.O. EXCITER OR TRANSMITTER

Part II—Constructing the transmitter

By I. QUEEN, W2OUX

A COMPACT and easy to operate rig, this unit is highly effective as a complete transmitter or as an exciter for a multiband unit. The heart of the transmitter is the variable frequency oscillator exciter and many interesting features have been incorporated. Among them are:

band transmitter and require only a stable v.f.o. exciter unit. This portion of the transmitter is at left in Fig. 1. It features two stages, a 6SJ7 electron-coupled oscillator and a 6F6 buffer. Output is more than sufficient to fully excite a 6L6, 807, or similar type amplifier, doubler, or final stage. The signal quality is equal to that of a crystal and drift

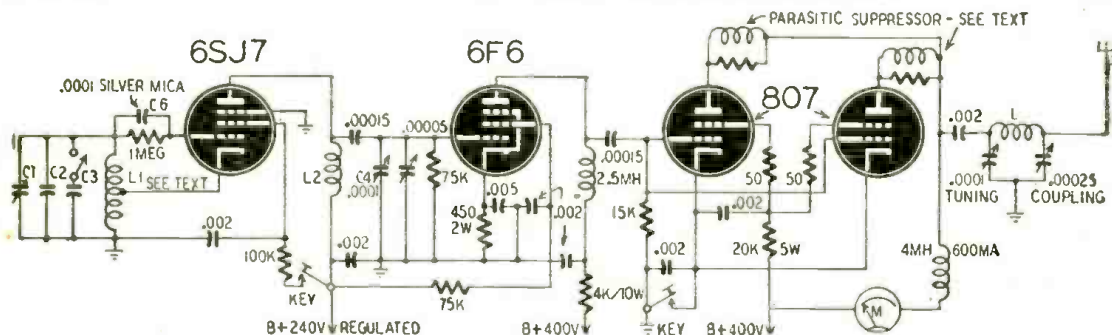

Fig. 1—Circuit of the exciter-transmitter. The e.c.o. is tuned to 160 meters, doubling in the plate circuit.

- V.f.o. circuit of high stability.
- Fundamental (80-meter) calibration covering approximately 19 linear inches.
- Good spread of other bands.
- Choice of oscillator or final keying.
- More than 50 watts output with only 400 plate volts.
- Panel meter calibrated in watts input to final.
- Only two major controls.
- Network matching any length antenna.
- Output continuously variable over wide range.
- Use as complete v.f.o. transmitter for 80 and 40 or as exciter for other bands.
- Break-in operation not affecting oscillation.
- Alternative crystal control.
- Many amateurs already have a multi-

is negligible after a minute or two. The high-C oscillator circuit uses a minimum of 850 μf capacitance (C2) made up of a 500- μf and a 350- μf condenser. These, together with the tuning coil, are enclosed in a shield can in one corner of the oscillator compartment (see photograph). The oscillator operates in the 160-meter band, for greater stability.

The coil is of the permeance-tuned type, 2 inches long

and $\frac{3}{8}$ inch in diameter. It was rewound with No. 28 wire to reach the 160-meter band with the iron core about halfway out. This required 40 turns, and the cathode tap is made 15 turns from the low end. After the exciter is completed and ready for calibration, the iron-core screw is adjusted to just reach 4 mc with the tuning condenser at minimum. This core adjustment is convenient for minor changes such as recalibration should such ever be necessary. Once set, it is locked by a nut tightened on it. The oscillator is tuned with a 140- μf mid-gate variable capacitor, anchored to the chassis and controlled by a National ACN dial.

In designing the electron-coupled oscillator, it was decided to concentrate all efforts on one tuned circuit for all bands which might be used rather than fall back on plug-in coils, switching arrangements or multiple-tuned circuits. On a percentage basis, the 80-meter is the widest. For example, of the entire 3.5- to 4.0-mc range, only the portion 3.5 to 3.65 doubles into the 40-meter band. Therefore if the 80-meter scale fills the dial, the 40 calibration is very crowded and occupies less than one-third of the scale. The situation is no better on other harmonic bands. The problem may be solved by using two sweeps of the dial to cover the 80-meter band.

As shown in the photograph, the outer scale covers from 3.5 to 3.73 kc, which multiplies conveniently. The second scale covers from 3.71 to 4.0 mc. To do this a fixed capacitance C3 is switched into or out of the oscillator circuit by the toggle switch under the dial, depending upon whether the lower or upper half of the band is to be worked.

A generous overlap is provided. This arrangement works out "fb." The excellent band spread makes it easy to zero-beat a signal and to estimate to about a kilocycle. With the smooth ACN vernier dial, the exciter becomes an accurate "signal generator" for amateur bands.

Adjustment of the high-frequency half of the band (from 4 mc) has been
(Continued on page 64)



Rear view of the unit. Note shunt across meter and jacks for keys.

THE CRYSTAL RADIO MAKES A COME-BACK

By HARRY WINFIELD

NOW that the fussy adjustment required with the old crystal detector has been done away with by the fixed crystal cartridge, the crystal receiver has had a rebirth. No batteries are required, and where a fairly long aerial can be used, the crystal receiver is quite satisfactory for picking up broadcast programs on a pair of headphones.

An aerial at least 75 to 100 feet long (longer if possible) and a good ground connection to a water pipe or other grounded metal system are essential. In some cases programs can be heard by simply connecting the aerial and ground posts of the receiver to a steam radiator and a metal bed or some other metallic mass. This is especially true near powerful broadcast stations. Of course the signals are much louder if an aerial is used, and increase directly with its length and height.

The crystal set does not amplify; therefore every bit of the original signal must be preserved and transferred to the crystal detector. One of the secrets of success with crystal sets is to use a pair of *highly sensitive* headphones.

The aerial wire can be of any convenient size, from No. 12 to No. 18 gauge copper. It should be as long and high as possible, and well insulated at each end. A length of insulated wire (such as bell wire) may be run along the baseboard or over the beams of an attic, to make an indoor aerial which

sometimes gives fair results. A ground clamp should be used to make *firm* connection to a water or steam pipe. In the country, when camping for instance, the radio may be grounded by connecting the ground wire to a piece

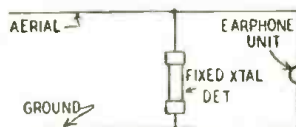

Fig. 1—Mystery radio's ultra-simple circuit.

of metal thrown into a stream. If a wire fence is handy, it may be tried as an aerial. Another way to pick up signals is to connect the aerial post of the set to one side of a condenser, the opposite terminal of the condenser being joined to one side of a telephone circuit.

Some of the new crystal receivers are illustrated on this page.

The mystery set

The simplest radio receiver imaginable combines a headphone with a crystal detector bridged across it. Such a combination is used in the "mystery" receiver illustrated in Photo A. The diagram of such a receiver (incidentally one of the first crystal sets ever used by the early experimenters) is given in Fig. 1.

The headphone in this receiver is a hearing-aid type and is so small that it fits into the ear. The fixed crystal detec-

tor fits inside the housing; all that remains are the 2 insulated wires with spring clips at their terminals. One clip may be connected to a water pipe and the other to an aerial wire or substitute metallic mass.

This set is useful as an emergency receiver or for other purposes, but has no tuner for selecting desired stations. The station intercepted will depend upon the natural frequency of the antenna system and the relative strength of local broadcast stations. If the aerial wire

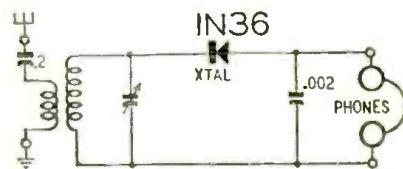

Fig. 2—The Revell radio circuit is standard.

is long, other stations may be tuned in by trying different size condensers in series with it. A variable tuning coil (one fitted with a slider) could be connected in series with the aerial and would provide some degree of tuning. A variable condenser in series with the aerial may also be tried.

Revell radar radio

A more ambitious crystal set is illustrated in Photo B. The diagram for this *tunable* receiver appears in Fig. 2. The drawing, Fig. 3, is a sectional view of the ingenious variable condenser used
(Continued on page 63)

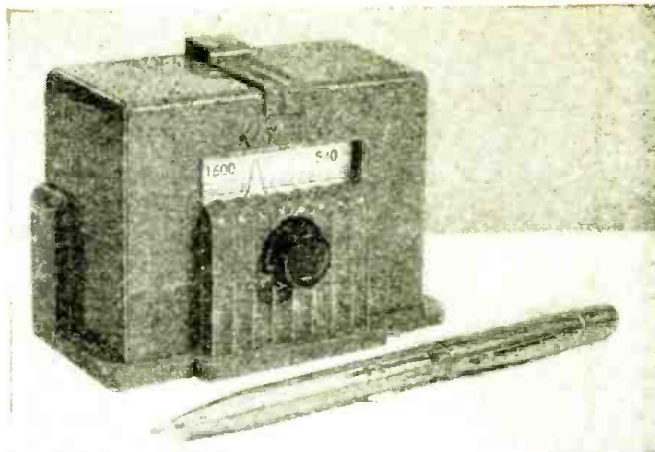

Photo B—The Revell radio is a highly-finished miniature receiver.

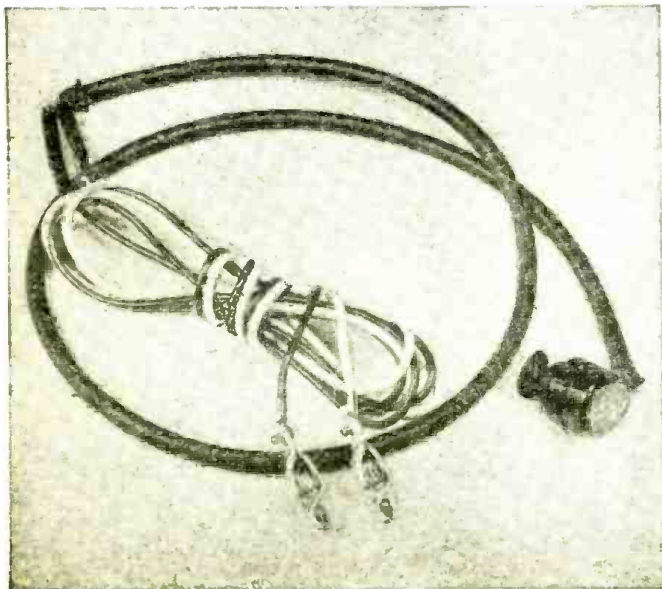
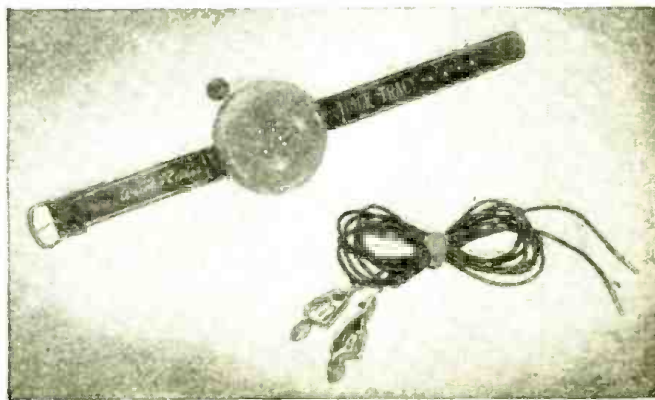
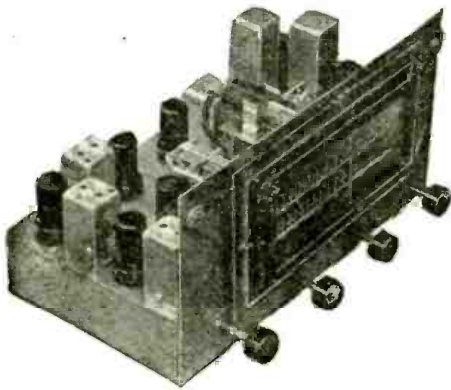

Photo A, left—Taybern Equipment's Mystery radio plugs in the ear. Photo C, below—Atomic radio, made by Da-Myco, is tuned by the stem.



RADIO SERVICE SET DATA



Browning FM-AM Tuner R-J-12

rack-mounting counterpart, the Model RJ-14, has a panel for mounting in a standard relay rack for laboratory or special installations.

The chassis consists of separate superheterodyne FM and AM circuits. The AM section tunes the broadcast band from 540 to 1650 kc and the FM section from 88 to 108 mc. The detection systems are connected alternately to the volume control through a section of the band switch and will give good results with an a.f. amplifier that will work with 0.1 volt input or more.

An audio amplifier, loudspeaker, antenna, and a power supply delivering 250 volts d.c. at 65 ma and 6.3 volts a.c. at 4 amperes are required to complete the installation. All voltage and control leads are brought into a terminal strip at the bottom of the chassis. If the

voltages cannot be supplied by the amplifier, a Browning Model PF-12 power supply, Fig. 2, can be used. A high-fidelity amplifier such as the Model RJ-12 amplifier, Fig. 3, is recommended for use with the tuners.

The tuner has a 4 x 8 inch slide-rule dial with separate 6 1/4-inch calibrated scales for FM and AM bands. Four walnut-colored bakelite control knobs are located symmetrically across the bottom of the chassis.

Although the RJ-12 is essentially two separate receivers, the circuits are arranged so that only four controls are used. The on-off switch, on the left side of the chassis, is connected to the terminal board so that it can make or break the a.c. power line to a power supply and amplifier that may be located some distance from the tuner. The sec-

THE Browning Model RJ-12 FM-AM tuner is one of the first of its kind to appear on the postwar radio market. It is supplied by the manufacturer as a chassis 7 3/8 inches high, 13 1/2 inches wide, and 9 inches deep, designed to be fitted into bookcases, shelves, drawers and other built-in installations in the home or office. Its

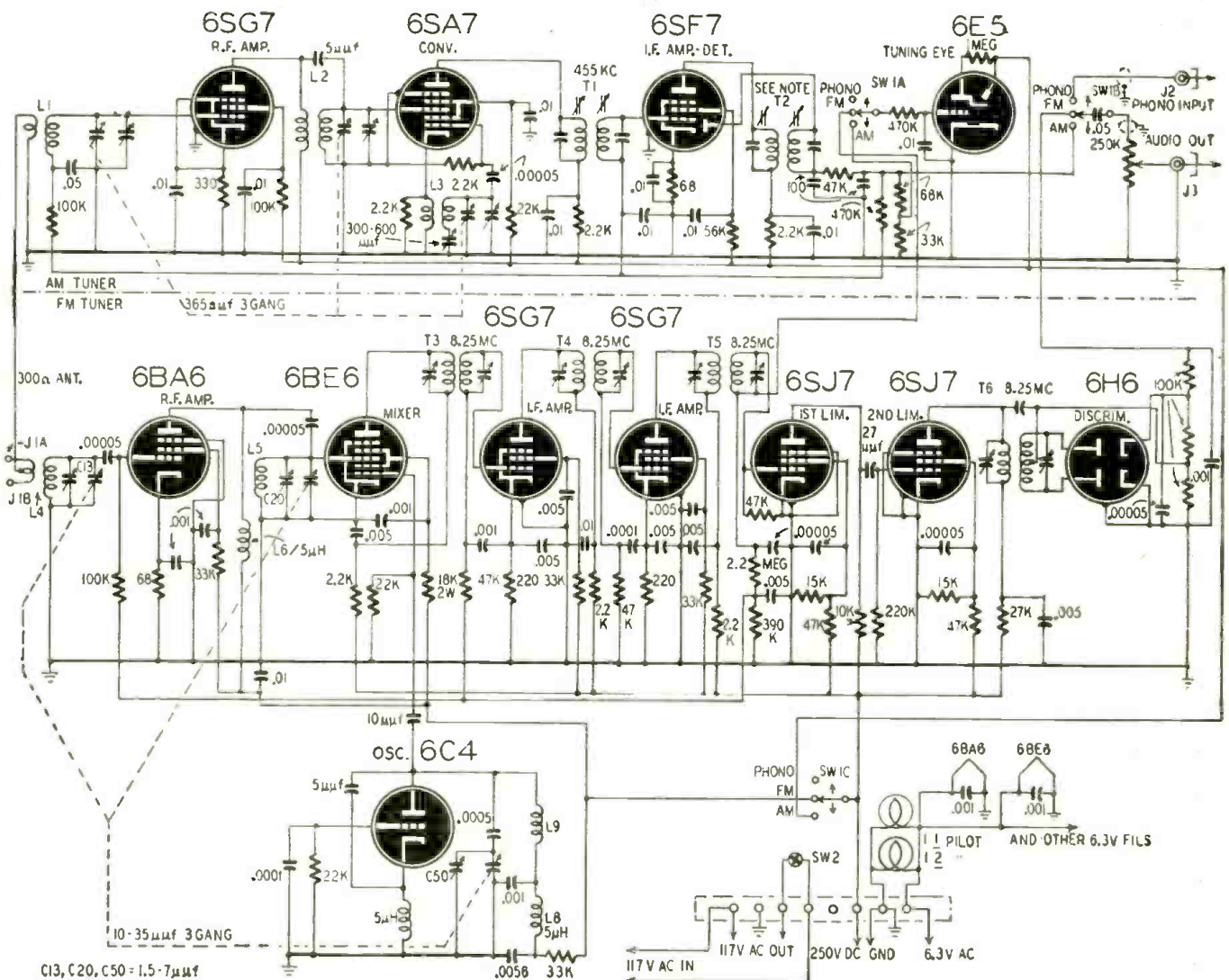

Fig. 1—This tuner is 2 receivers, using separate components throughout. Only the power supply and the volume control are common.

RADIO-CRAFT discontinues with this issue the Radio Data sheets. Printing 12 (or even 144) circuits a year has become meaningless. New models have been turned out literally by the hundreds. Means of securing information

about them by servicemen is excellently organized. The space will in the future be devoted to articles about new and different receivers and other radio equipment, new servicing methods (FM, etc.) and topical servicing subjects.

may well be applied to the same grid as the FM signal, to furnish a center marker. The discriminator is aligned in standard fashion.

An AM generator and a high-resistance voltmeter in the grid return of the first limiter is a less satisfactory alignment equipment, but can be used if better apparatus is not available. The

ond knob is the tuning control. A slow-tuning drive mechanism, requiring 10½ turns for complete band coverage on either band, is ganged to the tuning condensers of the FM and AM sections so that both are tuned together.

The band switch is the third control from the left. Its setting is indicated by markings on a scale visible through a small aperture in the center of the dial. In the FM position B-plus voltages are removed from the AM section. In the AM position, B-plus voltage is removed from the 6C4 high-frequency oscillator. In the phono position, plate voltages are removed from both tuners. Other sections of this switch connect the 6E5 tuning indicator and volume control to the section in use. The volume control—the right-hand knob—is connected through the switch to a phono input jack on the rear skirt of the chassis so that it can be used to control the volume of any phono attachment that may be used with the amplifier.

The circuit and tubes

The AM section consists of a 3-tube superheterodyne circuit using a 6SG7 r.f. amplifier, 6SA7 mixer-oscillator and a 6SF7 455-ke i.f. amplifier, diode detector, and a.v.c. voltage source for the i.f. and r.f. grids. The circuit is highly sensitive—the manufacturer claims a sensitivity of 1 microvolt or better over the entire band. The selectivity leaves little to be desired, even on the crowded high-frequency end of the band. The response curve seems to be sufficiently wide to pass the side bands of the average broadcast station and still provide adequate station separation.

The FM circuit is designed to work from a suitable antenna coupled to the input of the tuner through a 300-ohm line. The entire antenna system, dipoles and transmission line, is the antenna for the AM section. The front end of the FM tuner uses three of the new miniature tubes. They are: 6BA6 r.f. amplifier, 6BE6 mixer, and 6C4 separate oscillator tuning 8.25 mc higher than the signal frequency. The 6BE6 is followed by a 2-stage i.f. amplifier using 6SG7's, according to the schematic. The model tested used two 7AG7's in this position. The i.f. transformers are over-coupled to provide a band-pass of approximately 150 kc. They are followed by a 2-stage cascade limiter using 6SJ7's. These circuits are adjusted so that complete limiting takes place with a signal input of less than 15 microvolts. The limiter stages work into a Foster-Seeley discriminator using a 6H6. High-frequency de-emphasis is used on the output of this circuit to compensate for pre-emphasis at the transmitter.

Tested in a Manhattan office building with an indoor antenna, the FM tuner proved to have the expected wide-range audio response typical of FM. Since all FM stations heard were of good intensity it was impossible to make a sensitivity check on weaker signals. On AM, high-frequency audio response was definitely lower than on FM, as expected, because of normal side-band cutting. The AM sensitivity seems to be better than average for a set of this type.

When the tuning indicator is used on the AM channel, minimum shadow indicates correct tuning. On the FM band, the indicator beam overlaps and exact adjustment must be made by tuning for minimum background noise.

Servicing angles

The AM intermediate frequency is 456 kc, and alignment is standard. To align the FM section, a frequency-modulated signal generator and an oscilloscope is required for best results. The generator should have a sweep well in excess of 200 kc each side of the 8.25 mc i.f. General principles of visual FM servicing were discussed in the March, 1946, issue of RADIO-CRAFT. Note that this receiver is over-coupled to give a double-humped curve with a slight dip at the center frequency.

An AM signal of exactly 8.25 mc

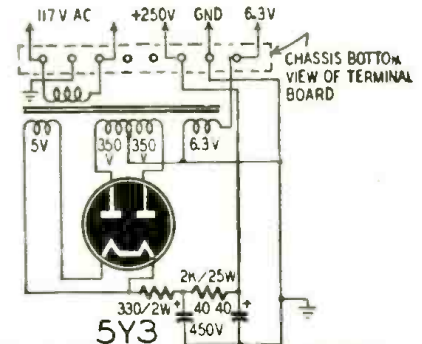
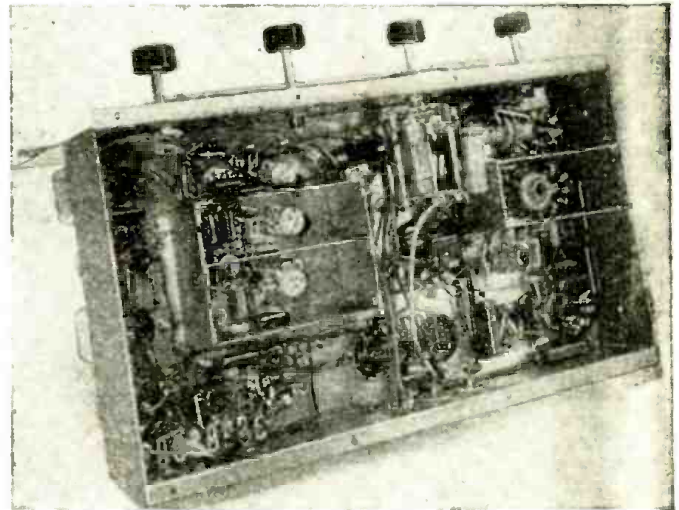

Fig. 2—The power supply for the FM-AM tuner.

method is to adjust to maximum meter reading (working back from the last i.f. transformer) at 8.25 mc. The generator is then varied in steps of about 20 kc each side of the center frequency, adjusting for a symmetrical curve, humped equally on each side of the center frequency.



Under side of the tuner. The shields in center enclose FM coils.

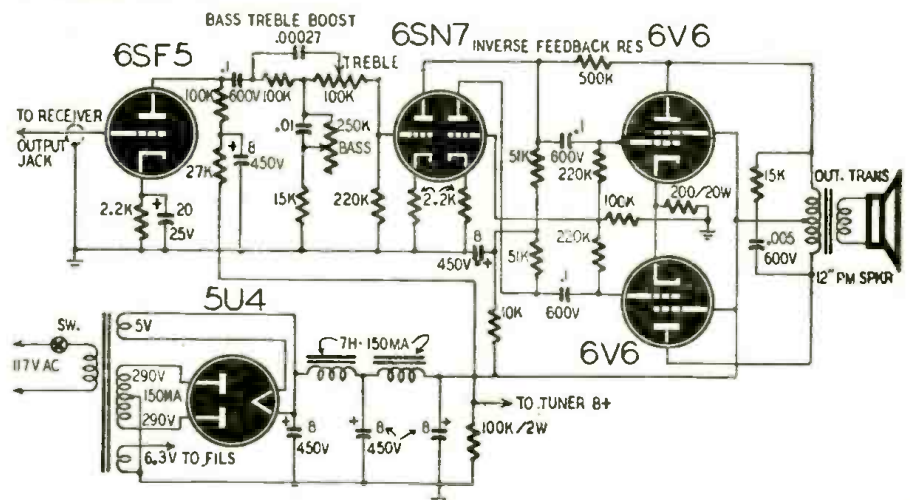
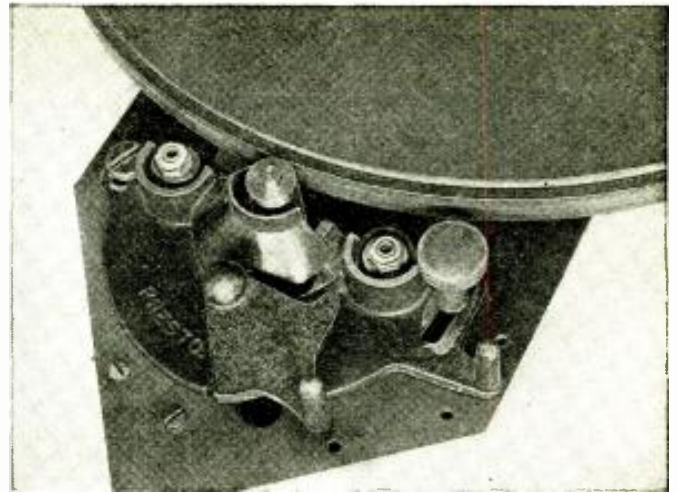

Fig. 3—Any good amplifier may be used with the tuner. This circuit is the Browning RJ-12.



Recorder working well, chip thrown clear and moving toward center.



Drive roller and rim must be kept free from dirt, damage or wear.

A Small Recording Studio

Part V — The commonest recording troubles

By J. C. HOADLEY

THE recorder who understands the fundamentals of his art will recognize most recording troubles as they appear. As a refresher for the skilled technician, and as a help to those who have not reached the professional stage, the following check list is appended. It contains the commonest causes of poor recordings, as well as the simplest methods of correcting them.

1. *Vibration being transferred from the drive motor to record.* This is evidenced by the appearance of spokelike or wavy patterns on the record, which herald rumble or wow or both.

It may be that the motor has excessive vibration because of improper centering of the armature, worn bearings, poor balancing of the armature, or an off-center drive pulley on the motor shaft. If the motor is mounted in rubber, it may be touching some part of the motor board, or the rubber may be hardened by age, oil, or heat. The motor may be adjusted too tightly against the rubber idler wheels so they do not reduce the vibration transmitted to the turntable.

The motor board may not be securely screwed down to the cabinet in which it is mounted. The plate on which the recording mechanism is mounted should be secured to a solid base, so that it cannot vibrate. Any vibration picked up by the motor will appear in the playback as a 60-cycle hum, which may vary in intensity throughout one revolution of the turntable.

Other record patterns can be caused by misalignment of any part of the overhead mechanism so that binding occurs. This can be so serious as to slow down the turntable for a small part of one revolution of the turntable. This will result in a very low frequency rum-

ble. It is too low to be heard as such but will cause a modulation of the higher frequencies, producing a noticeable wow. The ear is particularly sensitive to a change in pitch of a given tone, so even a very small variation in speed of the turntable during one revolution will result in a particularly displeasing effect.

Another noticeable pattern is an apparent difference in the spaces between the grooves, caused by inexpensive, poorly made, or defective lead screw or half nut follower, or both. There should be no play in the cutter carriage when it is lowered onto the lead screw. *It is wise to wiggle the carriage sideways to be sure the half nut is seated in the lead screw, as it is very disconcerting if it seats itself in the middle of a recording and ruins the disc.*

2. *High scratch level when recording is played back.* The most obvious cause is a dull cutting stylus, although it can be caused by a stylus set at the wrong cutting angle, by a poor quality blank, too hard material on the surface of the blank, or too deep cutting. Surface noise results also from a defective playback needle or one which does not match the groove radius. Dust is a common cause of surface noise, and casually wiping a disc builds up a static charge on its surface which makes the dust adhere more tenaciously. Discs should be kept in their envelopes when not being played.

A chipped sapphire playback stylus will ruin a disc with one playing, as the edges of the chipped spot are as sharp as a razor, due to the crystalline structure of a sapphire. A so-called permanent needle should never be removed from and later replaced in a playback pickup which has a needle chuck. It is almost impossible to put the needle back in the

same position. If it is rotated only slightly, it will present a sharp cutting edge to the record and ruin it.

3. *Playback pickup jumps grooves or skids across the surface of a recording.* The most prevalent cause of this ill is too shallow grooves. Playback pickups vary considerably in their ability to track a record. This ability is inherent in the design of the pickup and includes the compliance of the moving assembly, diameter of the stylus, point pressure, needle point impedance, design of the arm, and quality and freedom of the arm bearings.

Inexpensive pickups of the low-pressure type have difficulty in tracking high-amplitude low-frequency passages. This characteristic should be taken into account when a disc is made for a customer. It is wise to cut a record a little deeper and refrain from extreme low-frequency boosting when making a recording for someone who is going to play the disc back on a home radio-phonograph combination.

Groove jumping is caused also by too thin walls between grooves, particularly when played back with a lightweight pickup.

4. *Distortion which was not present in the material recorded.* Distortion may be caused by overloading the cutter head. This is particularly likely to happen when boosting the high or low frequencies. The recording level indicator cannot follow the peaks, which may be several times as high as the average recording level. It is wise to record at a level well under the maximum the head and grooves will stand.

Distortion can be caused by a recording amplifier which is defective or of insufficient power capability to have low distortion on the peaks. It is wise to have at least three times as much power available as the maximum level the head will stand.

Too light a cut will cause distortion because the needle cannot accurately

(Continued on page 57)

Rapid Checker For Capacity-Continuity

By ALFRED SHORTCUT

FOR the past five years a mechanic has been bringing me his condensers and coils for testing. Each time I have put the condensers on my Solar CC-160 and checked for leakage, then capacity. With my Weston 772 I have then determined if the coils were open. Since my friend is a washing-machine mechanic, specifically a Maytag mechanic, all the condensers are the same capacity and all coils the same value. Invariably, when this mechanic finds a motor that will not start he finds the cause is a coil (secondary open) or a leaky condenser.

Over a period of years of this testing, I have learned to make the tests quickly, and since the mechanic is my friend, there has been no charge. However, over this period of years, it has represented wasted time. The other day he asked, "Why can't you make a little gadget I can test these with?" I started thinking, and the unit which is the basis of this article was worked out.

There are hundreds of cases where a simple tester is needed to show leakage and if a condenser or coil is open this tester will serve that purpose.

While capacity of electrolytic condensers decreases as the electrolyte dries out, this is not the case with paper condensers. They usually have their rated capacity or are open. This characteristic makes them easier to test, especially in my specific case. For reasons of economy the instrument had to be a.c.-d.c., and for both economy and simplicity, it had to dispense with meters. With this in mind the circuit of Fig. 1 was dreamed up.

A receiving triode is used as a rectifier since the B current is negligible. Any type will do. A Type 37 was chosen because there were plenty of 5-prong sockets in the junk box. Because of the low current drain a simple R-C filter composed of R2 and C1 is sufficient.

The leakage-checking section is the familiar relaxation oscillator. With S DOWN, filtered d.c. is fed to the terminals. If a condenser is connected to the Cx terminals, any leakage in the condenser will allow a current to flow and charge C2. When C2 has charged to a voltage sufficient to ionize the neon bulb V2, it will flash and discharge C2 and the process will repeat itself. How often this occurs depends on the size of C2, the ionization voltage of V2, and the leakage resistance of the condenser under test. V2 and C2 are chosen so that the light will flash only at long intervals if the leakage of Cx is negligible.

The capacity-analyzing circuit of the tester is the really unique part. Since

it is necessary to know only that the condenser has capacity and not necessary to know how much capacity, as explained above, the circuit was made very simple.

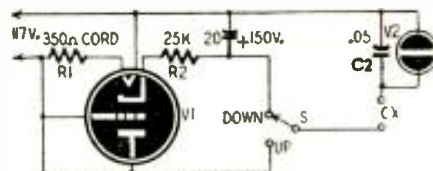
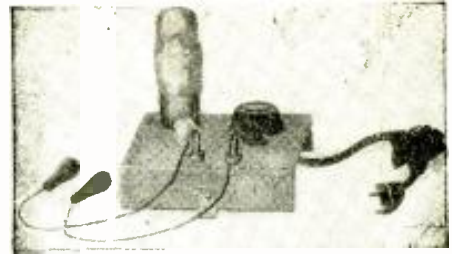

Fig. 1—Circuit diagram of the quick checker.

When S is UP, a.c. is fed to the Cx terminals. Since a good condenser will pass a.c., Cx and C2 act as a voltage divider. If Cx is large enough then the neon bulb lights, indicating Cx has capacity. If Cx is open or very low in capacity, there will not be enough voltage to cause V2 to light.



In using the checker, always check for leakage with S DOWN first. The neon bulb should blink only at very long intervals. If it blinks frequently or glows, discard the condenser. If this test is O.K. put S in the UP position. The neon bulb should glow.

The instrument can also be used as a continuity checker.

In my particular case, S is closed and the Cx terminals connected to the magneto coil to test it. Good coils cause the neon bulb to glow brightly. Defective coils cause a faint glow or blinking of the light, while coils entirely open produce no glow.

Construction of the instrument is very simple, and the figure and photograph are self-explanatory. For safety's sake, the circuit is insulated from the chassis, and the test clips insulated with rubber boots.

Parasitic Oscillations

MANY amateur rigs and even commercial transmitters are subject to parasitic oscillations unless proper precautions are taken. A parasitic is due to feedback from circuits or circuit elements of the transmitter. It can result in overheated tubes and components, poor efficiency, raspy signals, and undesired radiation. If the circuit responsible is concentrated (such as a choke coil) the parasitic frequency is much lower than the operating frequency. If it is distributed (as in conducting leads) the parasitic frequency is much higher.

A parasitic is heard as a rough, unstable signal when tuned in on a receiver. Its approximate frequency can be determined by tuning to the lowest frequency at which it appears, but this shaky note often comes and goes rapidly as the result of vibration or hand capacitance. A more definite indicator is a neon bulb held near the plate or grid lead of the suspected stage, with excitation off. It will glow yellow if the frequency is relatively low and will show red or purple on very high frequency. An incandescent bulb with the usual single-turn loop also can be used to detect the r.f. In many cases a milliammeter connected in the grid or plate head will show undesired oscillations.

Eliminating the parasitic is generally a cut-and-try procedure. Certain rules apply in every case. During attempts to reduce the oscillation the bulb or meter should be left connected so that improvement can be seen immediately if it occurs.

If the parasitic is known to be a low-frequency one it is due to the design of the set (type of components used, their position or their arrangement in the circuit).

It is preferable not to use choke coil coupling in both input and output. If it is necessary these chokes should not be alike. Tapped coils as in Fig. 1 also give trouble. By-pass condensers can resonate with chokes or coils to generate the low frequencies. Note in Fig. 2 that RFC1 and RFC2 make a t.p.t.g. circuit when tuned by circuit capacities and their own distributed capacitance. A good system is to short (or remove the tap) from one coil at a time and note the dif-

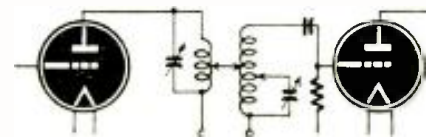
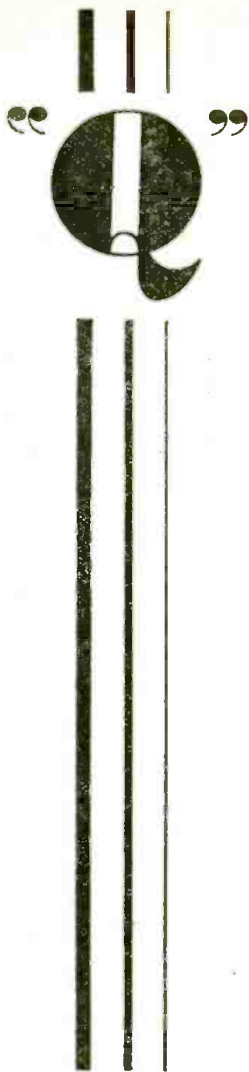

Fig. 1—Tapped coils are a source of trouble.

ference. The position of the coil sometimes makes a difference in the parasitic.

If there are no choke coils or tapped coils in the circuit the parasitic is likely to be a high-frequency oscillation. This can occur in any type transmitter since it is due to resonating leads. By-pass condensers should be connected directly at tube elements or power supply terminals. Even an inch or two of wire can set up a stubborn parasitic. Grid

(Continued on page 56)



Some facts on a much used, but not always well understood term, the "figure of merit" of a coil or other inductive element.

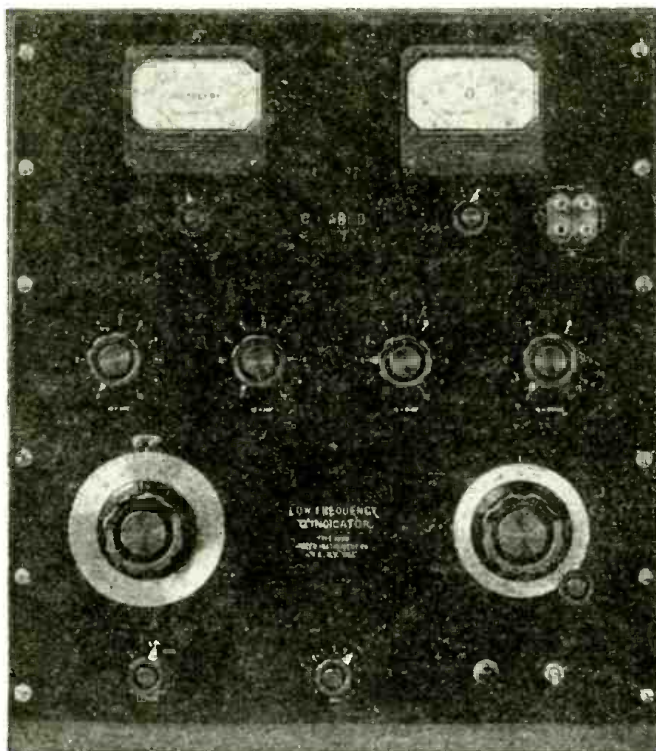

Courtesy Freed Instrument Co.
A commercial type of Q meter used for measuring large inductances.

By RAYMOND G. JOHNSON

THE symbol Q appears often in literature referring to the design of coils and tuned circuits. This quantity Q is defined by the ratio

$$\frac{\text{reactance}}{\text{resistance}}$$

Its importance is evident when it is considered that reactance and resistance determine circuit selectivity and sensitivity. Accurate determination of Q is usually required in laboratories and designers' workshops, but servicemen, technicians, and amateurs are more concerned with relative Q values.

It is usual to assume that the coil is responsible for all tuned-circuit loss because a good condenser has very little resistance. In other words, coil Q can be considered to equal circuit Q. The total resistance of a coil is due to: (1) d.c. resistance; (2) eddy currents and skin effect; (3) dielectric loss. Generally, high-frequency circuits have greater Q because of greater reactance. However, since total resistance also increases with frequency, the change is not as great as might be supposed at first. Actually, over a small frequency range, Q remains practically constant for any given circuit.

Fig. 1 shows a parallel resonant cir-

cuit which has been simplified for analysis by drawing the coil resistance R as a separate component. This leaves the coil as a pure inductance L. When tuned to resonance, the coil and condenser reactances are opposite and practically equal, so the r.f. tank current (I) is equal to E/R . The voltage across the resistance is IR and across the coil is IX where X is the reactance found from the formula $2\pi fL$. Since $Q = X/R$, a simple development of the equation shows that $X = QR$, from which it is apparent that the voltage across the coil is Q times as large as the total circuit voltage. Note that THE TOTAL IMPRESSED OR INDUCED CIRCUIT VOLTAGE IS MAGNIFIED Q TIMES BY THE RESONANT CIRCUIT.

Because of the higher reactance/resistance ratio, a high-Q circuit tunes more sharply and produces a higher peak voltage at resonance than a circuit with a low Q. Therefore, the tank coils of sharply tuned voltage amplifiers should be designed for high Q. This high Q is gained by reducing the resistance for a given reactance or by increasing the reactance without proportional increase of resistance.

Low coil resistance is obtained by using good insulation and dielectric materials such as polystyrene, quartz, or isolantite. At v.h.f., the conductors should be made of metal tubing or

ribbon, preferably silver-plated, to minimize skin effect. If shielding is used around a coil, it should not be too close because of eddy-current loss.

For a given size and shape of coil, the reactance may be increased by using an iron core. The core is made of finely divided alloy which greatly increases the effective permeance without proportional increase of resistance due to eddy currents. The net reactance may also be increased by minimizing the distributed capacitance between turns of the coil. This can be done by space-winding, which is especially important at higher frequencies.

To calculate a coil's Q, its reactance and resistance must be known. The first may be determined from charts or tables giving inductance from coil dimensions. Unfortunately, the second represents a very difficult problem because of the many variables. It is much easier to measure the Q of a coil without knowing its resistance. The Q meter is widely used in laboratories and manufacturing plants. Fig. 2 shows its basic schematic. The instrument requires an r.f. generator, variable condenser, and 2 voltmeters. One voltmeter must measure values in the neighborhood of 0.02 volt, and the other is designed for the range of about 5 volts. As shown in the diagram, the low-reading meter is usually an r.f. current meter in series with a known resistance.

To operate the Q meter, the coil to be measured is connected across L and the generator is adjusted to the desired frequency. The r.f. output is increased until the voltage across R is some convenient value, say 0.02 volt. As a practical example, R may be 0.04 ohm and the ammeter adjusted for 0.5 ampere. The condenser is then adjusted for resonance and the voltage is noted on the vacuum-tube voltmeter. If it happens to be 2 volts, the Q of the coil would be $2/0.02 = 100$. This follows

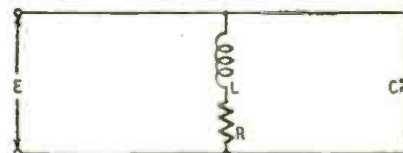

Fig. 1—Equivalent coil-condenser circuit. from the magnification property of the resonant circuit. Note that R must be low enough not to interfere seriously with the remainder of the circuit but must be large in comparison to the coil resistance.

In replacing coils in radio receivers it is important to substitute one with approximately the same Q. A lower value

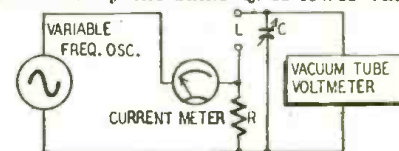

Fig. 2—Simplified schematic of a Q meter. reduces sensitivity, while a higher value may cause instability or oscillation. For this purpose, a comparative Q meter is sufficient. The meters of Fig. 2 need not be calibrated in exact values. The v.t.v.m. is used merely to indicate relative Q.

ANTENNA PRINCIPLES

PART VIII---Metallic lens and electromagnetic horn antennas

A NEWCOMER to the microwave field of transmission and reception is the *metallic lens system* developed recently by the Bell Telephone Laboratories. Operating at wave lengths of less than 5 centimeters, the system (Photo A) consists of a large, square metal lens. Action is analogous to that of light waves: a glass lens slows down the light passing through it, and the thicker the glass the greater the effect. A double-convex lens slows light rays nearest its optical center more than those nearer the periphery. In this manner, the light rays can be brought into focus at some point beyond the lens.

Similarly, microwaves *gain speed* in passing through wave guides or between resonant metal plates. And a metal lens system—consisting of a geometrical arrangement of such plates—can be used to equalize the wave front of microwaves, thus concentrating the energy in a given direction.

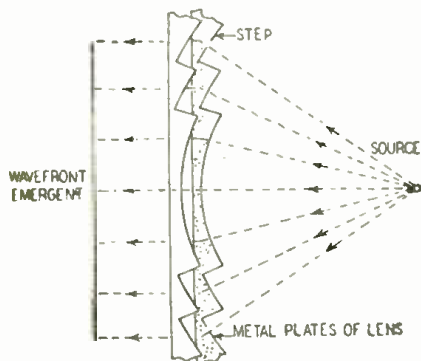

Fig. 1—Cross-section of metal-lens antenna.

When microwaves from a point source (Fig. 1) pass through the wave-guide-like sections of the lens, they are speeded up because of the dimensions and arrangement of the multiplate metal lens. These shaped plates speed up the edges of the beam relative to the center so that the emerging wave front is flattened—since the path between metal plates is longer at the sides than at the center.

Avoidance of long paths between plates through “stepped” construction, besides saving material and weight, results in uniform transmission over a very wide frequency band. This is an important advantage in broad-band microwave communication systems.

The arrays of metal plates have been made in a variety of sizes, from those only a few inches square for millimeter transmission and reception to the largest array for use with 5- and 6-centimeter waves. With the latter array it's possible to obtain a radiation pattern less than one-tenth of a degree in width, an important advance in microwave directivity.

By **JORDAN McQUAY**

Metallic lens systems shortly will be used in intercity links for the simultaneous transmission of television, telephone, telegraph, facsimile, teletype, and other services—all possible with microwaves only a few centimeters in length.

Electromagnetic horns

Another unidirectional u.h.f. radiator is the *electromagnetic horn*, of which there are two principal types: the sectoral horn and the conical horn (Fig. 2).

Shape of these devices is such that microwave energy is concentrated in a particular direction. The field pattern is influenced by the shape of the horn, mouth and throat dimensions, and the mode of waves being radiated. The horn is normally fed by a wave guide system. It may be considered as a sort of transformer, which matches the wave guide to free space and thus prevents standing waves within the wave guide feed system.

For proper matching, the width of the mouth should be about 10 wave lengths. Height of the mouth, not so critical a dimension, can be between 4 and 7 wave lengths. The throat of the horn normally will be the same size as the cross-sectional dimensions of the waveguide feed system. Electromagnetic horns may be used over a moderately wide band of operating frequencies.

Specific design data is beyond the scope of this article, primarily because of complications introduced through the use of wave guides. Actual or practical dimensions will vary according to the *mode of such* waves, and according to phase distribution at the mouth of the horn. Waves must be in phase for maximum forward radiation. The amount of directivity is determined by the amount of flare, or flare angle, between the throat and mouth of the horn.

The same horn can be used for both transmitting and receiving. But waves must be of correct mode and polarization for a particular horn. Horns are more often used for transmitting than receiving.

All types are constructed of thin sheet metal. All inner surfaces and joints must be smooth and well polished.

The *sectoral horn* (A in Fig. 2) is commonly used because it can be excited by any of several different wave modes, the nature of each mode influencing the design of the actual horn. This type of horn is also used to feed or radiate energy into parabolic reflectors. The sec-

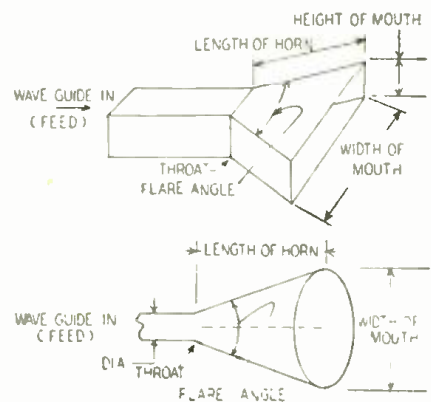

Fig. 2—Sectoral and conical horn radiators.

toral horn is flared in only one dimension. The optimum flare angle is between 40 and 60 degrees when the length of the horn (distance from throat to mouth) is about the same as the width of the mouth. Most of these values can be determined experimentally, without involved calculations or without knowledge of the exact mode being transmitted or received.

Field pattern will favor directivity in the plane perpendicular to the width of the horn mouth. Thus the horn shown

(Continued on page 73)

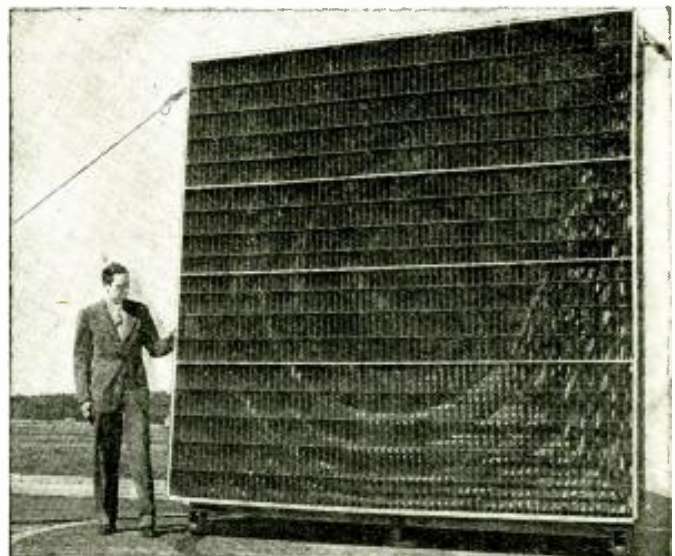
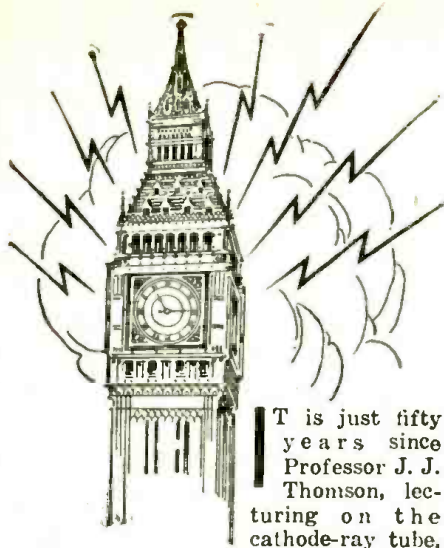

Photo Bell Telephone Laboratories

Photo A—A large stepped metallic lens used for 5-centimeter waves.

Transatlantic News

From our European Correspondent, Major Ralph Hallows



It is just fifty years since Professor J. J. Thomson, lecturing on the cathode-ray tube, identified the constituents of the beam as minute charged particles, far smaller and lighter than the atom, which had been regarded until then as the smallest body in existence. Thomson called the particles "corpuscles." The name *electrons* was not adopted for them until some time later, though it was first coined in 1874 by Professor Johnstone Stoney of Dublin. In that year Stoney suggested that an electric current consisted of a stream of negatively charged particles, which he called *electrons*; but not till after Thomson's work on the cathode-ray tube could his conjecture be proved. The universal adoption of the name *electron* is a fitting recognition of Johnstone Stoney's early work. We've advanced a long way since then, and, thanks to the development work done on atomic energy, we have revised our ideas about the nucleus of the atom during the past few years. Not many physicists now agree with the statement still to be found in textbooks, that the nucleus contains individual electrons. The coming idea seems to be that it consists of neutrons and protons only. But just what forces bind the nucleus into a bundle so tight and so difficult to unfasten is still a mystery. There is still in some of our atomic laboratories a feeling that neither the neutron nor the proton may be found eventually to be simple bodies. The proton, representing

unit positive charge, weighs 2,000 times as much as the electron, which represents unit negative charge. This scarcely seems a logical arrangement, and it is now being suggested that both neutron and proton may be conglomerations of about 1,000 positive particles, or positrons, and 1,000 negative particles, or electrons. If that is so, a neutron is composed of an equal number of positrons and electrons, the positive and negative charges neutralizing one another; the proton would contain, say, 1,001 positrons to 1,000 electrons and so have unit positive charge. Should this idea have any foundation in fact, the breaking up of the neutron might furnish a vastly richer store of atomic energy than nuclear fission.

and a very interesting type was shown at the exhibition. Attached to the oscillator, it acts as a frequency modulator and enables response curves to be obtained on the oscilloscope when receiver alignment is in progress.

Radio for the deaf

One of the neatest radios that I have seen among those especially designed to enable the deaf to listen to broadcast programs has just made its appearance here. It may be described as a family model, being just as useful to those of the household who have normal hearing as to the deaf person. With the switch in position 1 the set works as an ordinary radio, operating its loudspeaker. Position 2 cuts in a pair of headphones in parallel with the speaker and provided with separate tone and volume controls. In position 3 the loudspeaker is out and only the headphones are working. Put the switch to position 4 and the apparatus becomes a deaf-aid, enabling the person with defective hearing to take part in general conversation. This is done by bringing into action a crystal microphone with a wide angle of response, connected through the a.f. circuits to the headphones. In addition the headphone circuit is provided with an output limiter to protect the deaf listener from the shock of sudden loud noises. You can imagine what a blessing this instrument may be to those who suffer from one of the greatest of all handicaps, defective hearing.

Measuring instruments

Among the most interesting of the radio and electrical appliances at the recent exhibition of the Physical Society in London were the high-grade multi-range devices for measuring current and voltage. I was much struck by one with 40 a.c. and d.c. ranges, which is certified to have sub-standard accuracy on d.c., and on a.c. to work within one-half of the tolerances permitted by the British Bureau of Standards for first-grade instruments. Another instrument gives a full-scale deflection for 50 microamperes of direct current, the resistance of the voltage scales being 20,000 ohms per volt. Voltage up to 2,500 can be measured. On a.c. the resistance is 1,000 ohms per volt and there is again a range up to 2,500 volts.

I wonder whether American radio servicemen know the joys of using the wobulator? The "wob" was originally a radar device, designed to vary the recurrence frequency of the transmitter and so to enable two radar stations to operate on the same carrier frequency without giving rise to mutual interference. Now a wobulator attachment has been designed for the service oscillator

Mountain antenna mast

One of the most remarkable antenna systems ever erected is in a lonely spot in southwest England. The British Post Office has for many years been operating at Rugby a high-powered 16-kc transmitter, used for world-wide contacts. During the war it was decided to erect a reserve transmitter of the same power output rating at a place less liable to enemy bombing. Actually the work was done only just in time, for the Rugby station was eventually put out of action. The biggest problem in building the new station was antenna masts. Only 3 600-foot self-supporting towers were available and there was no possibility of making others, since every ounce of steel was required for other purposes. As the antenna current was to be some 400 amperes with a peak voltage of 220,000, a large antenna capacitance was necessary. It did not seem possible to produce the required 15,000-20,000 μf with any arrangement using only the 3 towers as supports. Then the idea illustrated in the drawing was thought of. As a result of intensive high-speed reconnaissance a hill 1,200 feet high with a very steep forward slope was found in a suitable locality in the West Country. The

(Continued on page 73)

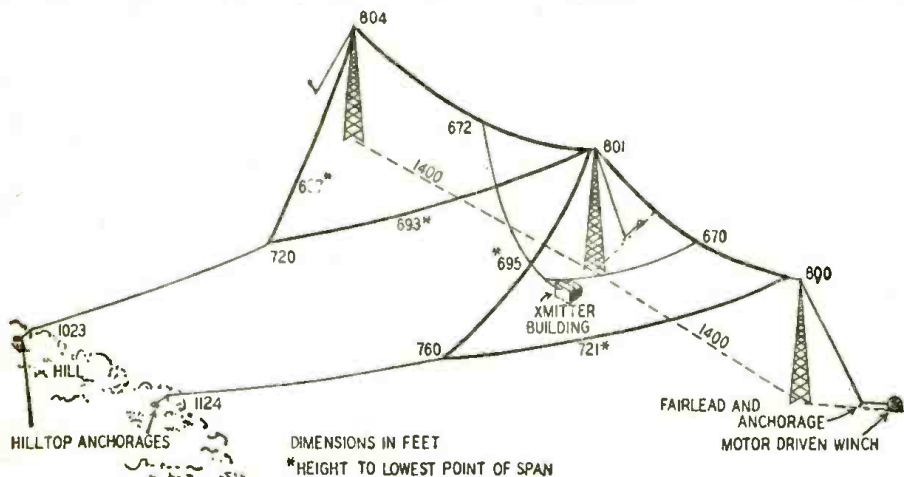

How a mountain is used as a mast to support one end of a giant broadcasting antenna.

Prepare **NOW** for a Better Job *in* the Field of Radio!



**Don't Delay—
Write Today!**

Greater Knowledge means Greater Opportunities!

Yes, Mr. Radioman, there are innumerable more and better jobs in the Field of Radio as a result of war-developed techniques—Mobile Communication Systems for Automobiles, Busses, Trains, many Industrial Applications, Micro-Wave Relay Systems, FM Broadcasting, Television—these are just a few of the many new opportunities open to you who are alert—and are qualified!

Let Cleveland Institute Take Over Your Personal Up-Grading Problem!

Qualified, competent instructors, ample, personalized instructional aids, orderly, progressively arranged study assignments in recognized, approved technical texts—these are only a few of the many superior advantages of CIRE'S plan of personalized spare-time home study training for professional self-improvement.

CLEVELAND INSTITUTE COURSES OFFER COMPLETE TECHNICAL TRAINING RANGING FROM LOW-LEVEL TO COLLEGE-LEVEL.

- A. Master Course in Radio Communication. Covers complete preparation for broadcast station employment including preparation for FCC License Examinations.
- B. Advanced Course in Radio Communication Engineering. A college-level Radio Engineering Course.
- C. Specialized Television Engineering. Including post-war Television Techniques.

All Courses Include

The Remarkable Workbooks of Instructional Aids, prepared by the instructing staff of Cleveland Institute.
Choose the course best suited to your needs—Start with the section you are qualified to enter—Use the economical CIRE "Pay-As-You-Go-Plan."

CLEVELAND INSTITUTE OF RADIO ELECTRONICS

Contractors to the Canadian Broadcasting Corporation

**RC-7 Terminal Tower
CLEVELAND 13, OHIO**

Approved for Training under "G-I Bill of Rights"

ENROLL FOR INDIVIDUAL SECTIONS OF COURSES, IF YOU PREFER

If you need only highly specialized training, you can study one or more of the following sections instead of a complete course.

1. Mathematics of Radio.
2. Fundamentals of DC and AC Theory.
3. Essentials of Radio Communication.
4. Communication Networks.
5. Advanced Radio Telephony for the Broadcast Operator.
6. Audio and Radio Components and Systems (Design of Receiver and Transmitter Equipment).

(MAIL THIS COUPON)

Cleveland Institute of Radio Electronics, RC-7, Terminal Tower, Cleveland 13, Ohio.

Gentlemen: Please send information about your home courses in Radio Electronics.

NAME I desire training in A B C
 ADDRESS I have had experience in broadcasting servicing
 CITY operating mfg. CAA Army-Navy
 ZONE STATE amateur other I am a
 High School Grad. College Degree
 Check here for Veteran Enrollment Information.



Get your

FCC Commercial Radio Operators' LICENSE NOW!

**Don't Delay—
Write Today!**

IT'S EASY IF YOU FOLLOW OUR PLAN!

Thousands of new jobs are opening up—FM, TELEVISION, MOBILE COMMUNICATIONS SYSTEMS, are only a few of the radio fields which require licensed operators.

TIME IS IMPORTANT TO YOU!

You can get your License quickly with **NILSON'S MASTER COURSE** in RADIO COMMUNICATION and exclusive CIRE Workbooks of Instructional Aids. Saves you many hours of random, undirected study.

Assures a MINIMUM of time in getting your ticket.

FREE BOOKLET tells you the Government Requirements for all classes of commercial licenses—Sent immediately upon receipt of coupon.

Approved for Veteran Training under "G-I Bill of Rights"

MAIL THIS COUPON

CLEVELAND INSTITUTE OF RADIO ELECTRONICS
 RC-7 Terminal Tower, Cleveland 13, Ohio
 Gentlemen: Please send information about your Home Study Course for preparation for FCC Commercial License Examinations. (Does not cover Amateur License Examinations.)

Name
 Address
 City Zone State
 If a Veteran check here

CLEVELAND INSTITUTE OF RADIO ELECTRONICS

Contractors to the Canadian Broadcasting Corporation

**RC-7 Terminal Tower
CLEVELAND 13, OHIO**

6-BAND COMMUNICATIONS RECEIVER BC-348

Featuring coverage from 200 to 500 Kc. and 1500 to 18000 Kc. on a direct reading dial with the finest vernier drive to be found on any radio at any price—high sensitivity with a high degree of stability—crystal filter—BFO with pitch control—standard 6 volt tubes. Contains a plate supply dynamotor in compartment within the handsome black crackle finish cabinet, the removal of which leaves plenty of room for installation of a 110V, 25 or 60 cycle power supply. These receivers, which make any civilian communications receiver priced under \$200.00 look cheap and shabby by comparison, are only \$44.50. Power supply kit for conversion to 110V, 25 or 60 cycle, is only \$8.50 additional.

ARMY BC-312 COMMUNICATIONS RECEIVER

This receiver covers the frequency range of 1.5 MC to 18 MC in six direct reading bands. The dial, that is driven with split gears to prevent backlash, has 4500 logging divisions per band with approximately 600 divisions on the 20 and 40 meter ham bands and 1000 divisions on 80 meters. Two stages of RF before the converter in this set give it a very high signal to noise ratio and maximum sensitivity. Outstanding features of this receiver are: BFO with pitch control, send-receive relay, jacks on the front panel for headphones and speaker output and mike and key input, all tubes are standard 6 volt types. This receiver was designed to withstand rough usage in the field and for operation from vehicles while in motion, so it is ruggedly constructed and contains a dynamotor power supply—Your cost—\$49.95. Conversion kit 110 VAC is available for . . . \$6.50

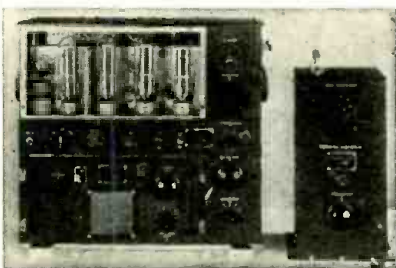

**GENERAL ELECTRIC
150 WATT
TRANSMITTER**

**Cost the Government \$1800.00
Cost to you \$44.50!!!!**

This is the famous transmitter used in U.S. Army bombers and ground stations, during the war. Its design and construction have been proved in service, under all kinds of conditions, all over the world. The entire frequency range is covered by means of plug-in tuning units which are included. Each tuning unit has its own oscillator and power amplifier coils and condensers, and antenna tuning circuits—all designed to operate at top efficiency within its particular frequency range. Transmitter and accessories are finished in black crackle, and the milliammeter, voltmeter, and RF ammeter are mounted on the front panel. Here are the specifications: **FREQUENCY RANGE:** 200 to 500 KC and 1500 to 12,500 KC. (Will operate on 10 and 20 meter band with slight modification). **OSCILLATOR:** Self-excited, thermo compensated, and hand calibrated. **POWER AMPLIFIER:** Neutralized class "C" stage, using 211 tube, and equipped with antenna coupling circuit which matches practically any length antenna. **MODULATOR:** Class "B"—uses two 211 tubes. **POWER SUPPLY:** Supplied complete with dynamotor which furnishes 1000V at 350 MA. Complete instructions are furnished to operate set from 110V AC. **SIZE:** 21 1/2 x 23 x 9 1/4 inches. Total shipping weight 200 lbs., complete with all tubes, dynamotor power supply, five tuning units, antenna tuning unit and the essential plugs. These units have been removed from unused aircraft but are guaranteed to be in perfect condition.

**GENERAL ELECTRIC RT-1248 15-TUBE
TRANSMITTER-RECEIVER**

TERRIFIC POWER—(20 watts) on any two instantly selected, easily pre-adjusted frequencies from 435 to 500 Mc. Transmitter uses 5 tubes including a Western Electric 316 A as final. Receiver uses 10 tubes including 955's, as first detector and oscillator, and 3-7H7's as IF's, with 4 slug-tuned 40 Mc. IF transformers, plus a 7H7, 7E6's and 7F7's. In addition unit contains 8 relays designed to operate any sort of external equipment when actuated by a received signal from a similar set elsewhere. Originally designed for 12 volt operation, power supply is not included, as it is a cinch for any amateur to connect this unit for 110V AC, using any supply capable of 400V DC at 135 MA. The ideal unit for use in mobile or stationary service in the Citizen's Radio Telephone Band where no license is necessary. Instructions and diagrams supplied for running the RT-1248 transmitter on either code or voice, in AM or FM transmission or reception, for use as a mobile public address system, as an 80 to 110 Mc. FM broadcast receiver, as a Facsimile transmitter or receiver, as an amateur television transmitter or receiver, for remote control relay hook-ups, for Geiger-Mueller counter applications. It sells for only \$29.95 or two for \$53.90. If desired for marine or mobile use, the dynamotor which will work on either 12 or 24V DC and supply all power for the set is only \$15.00 additional.

RADAR INTERCONNECTOR UNIT, contains 15 tubes—\$29.95. **C-144 TRANSMITTER,** 2 type 826 tubes as oscillator in lecher line tuning circuit that resonates between 150 and 200 Mc. Contains 3 DC power supplies that operate from 110v 60 cycles, 10 tubes, meter, circuit breaker, and carrying case—\$49.95.

AIRCRAFT AMPLIFIER C1—This unit is housed in an aluminum case that is 9x8x7 inches and contains 1-7Y4, 3-7N7, 3-7F7 and six 5000 ohm sensitive relays. This unit is brand new and in its original packing 9.95

BC-654 TRANSMITTER-RECEIVER—Brand NEW with 17 tubes, key, microphone and calibrating crystal \$39.95

BENDIX SCR 522—Very High Frequency Voice Transmitter-Receiver—100 to 156 MC. This job was good enough for the Joint Command to make it standard equipment in everything that flew, even though each set cost the Gov't. \$2500.00. Crystal Controlled and Amplitude Modulated—HIGH TRANSMITTER OUTPUT and 3 Microvolt Receiver Sensitivity gave good communication up to 180 miles at high altitudes. Receiver has ten tubes and transmitter has seven tubes, including two 832's. Furnished complete with 17 tubes, remote control unit, 4 crystals, 24 volt dynamotor and the special wide band VHF antenna that was designed for this set. These sets have been removed from unused aircraft and are guaranteed to be in perfect condition. We include free parts and diagrams for the conversion to "continuously-variable frequency coverage" in the receiver. The cost of this unit is only \$37.95. A brand new 12V. 622 dynamotor is available for \$3.00 additional with the purchase of a 522, or separately for \$15.00.

Minimum order \$3.00 — All prices subject to change — 25% deposit with COD orders.

SERVICEMEN

Check This Column for Lowest Prices on Quality Parts

Tubes: A warehouse full, including the new miniatures. Order all the types you need and we will try to supply you completely. The following prices are for fifty or more assorted tubes, 5% less in lots of 100 or more. 27. 5Y—38c; 26. 3Z5—56c, 75. 44c; 76. 78. 6J5. 50c; 6SK7, 6XQ7, 12SA7, 12SQ7, 5U4, 6T6, 6D6, 6SA7. 54c; 6SJ7, 12SJ7, 5Y4, 5Z3, 6K6, 6K7, 6V6, 6SD7—60c; 6J7, 6K8, 6SF7, 72c; 5Y4, 6F7, 12BA6, 12AT6, 6BE; 6L6, 99c; 32L7, 1.08; 50B5, \$1.28. These special prices on tubes are for one month only.

POWER TRANSFORMERS—Half-shell type. 110V, 60 cy. Centertapped HV winding. Specify either 2.5 or 6.3V filament when ordering.

For 4-5 tube sets—650V, 40MA. 5V & 2.5 or 6.3V. . . . \$1.49
For 5-6 tube sets—650V, 45MA. 5V & 2.5 or 6.3V. . . . 1.75
For 6-7 tube sets—675V, 50MA. 5V & 2.5 or 6.3V. . . . 1.90
For 7-8 tube sets—700V, 70MA. 5V & 6.3 or two 2.5. . . . 2.35
For 9-11 tube sets—700V, 100MA. 5V & 6.3 or two 2.5V. . . . 2.85
For 9-15 tube sets—600V, 150MA. 5V & 6.3V. . . . 2.95

TRANSFORMERS—All types in stock. **AUTO-TRANSFORMERS:** Steps up 110v to 220v, or steps down 220v to 110v—\$1.95. **FL. TRANS:** 6.3v, 8 Amps—\$1.98; 5v, 10 Amps—\$1.98; Universal Output Trans. 8 Watt—89c; 18 Watt—\$1.29; 30 Watt \$1.69. **AUDIO TRANSFORMERS:** S. Plate to S. Grid. 3:1—79c; S. Plate to P.P. Grids—79c; Heavy Duty Class AB or B. P.P. Inputs—\$1.49; Midset Output for AC-DC sets—69c; **MIKE TRANSFORMER** for T-17 Shure microphone, similar to UTC oncer type—\$2.00.

CONDENSERS—PAPER TUBULAR 600 WV—.001, .002, .005—8c; .01, .05—9c; 1—10c; .25—33c; 5—36c; **ELECTROLYTICS:** 8mfd 200v—20c; 10mfd 35v—20c; 30mfd 150v—23c; 20/20mfd 150v—35c; 30/20 150v—46c; 50mfd 150v—43c; 8mfd 475v—34c; 16mfd 350v—65c; **OIL CONDENSERS:** 4mfd 600v 49c; **BATH TUB TYPE CONDENSERS:** 3X.1mfd—20c; **RESISTORS:** All types in stock at the lowest prices; Resistor Kits; 100 2 watt resistors—\$1.95.

FILTER CHOKES: 200, 300, 400, 500 ohm light duty—59c; 200 or 300 ohm heavy duty—99c; 2:0 ma 35 ohm, made for U.S. Navy, fully shielded—\$1.95; 75 ohm 125 ma—25c or 25 for \$4.25; "Mellor" type; tapped filter chokes—25c; 8 amp. iron core A filter—25c; Choke-condenser combination, ideal to replace any size speaker field when installing PM speakers—79c. **110 V. CIRCUIT BREAKERS** of Magnetic type; Following Current Ratings in Stock: 1.25, 3, 4, 8 Amps. Please specify. \$1.95 each. Seven Assorted I.F. Transformers—\$1.98; Five Ass'd. Oscillator Coils—69c.

WILLARD rechargeable 2 volt storage batteries for G.E. portable radios \$2.95.

SPEAKERS—PM dynamic type—4"—\$1.55; 5"—\$1.55; 6"—\$1.95; 8"—\$3.95; 10"—\$5.95; 12"—\$7.50.

HEADPHONES—Highest quality Sigmak Corp. headsets with sponge rubber ear cushions, 12" cord and plug \$1.25. 5" rubber covered patchcords with phone plug and socket—45c.

RELAYS—Guardian SPST 12-24v. Has heavy duty 15 Amp. Contacts—\$1.25; Guardian 12 to 24v D.C. triple make, single break relay, 5 for \$3.75; Sigma supersensitive 2000 ohm D.C. SPDT Relay. (May be adjusted to operate on less than 1 Milliampere)—\$2.50; 6 Pole, Double Throw, Telephone Type 2000 ohm Relays, Super Sensitive, \$2.50 ea., or two for \$4.50.

SELENIUM RECTIFIERS—Dry disc type 1 1/2" by 1", 1.2 Amp. maximum, suitable for converting DC relays to AC, for supplying filament source in portable radios, converting DC meters to AC applications, and also may be used in low current chargers—90c.

METER RECTIFIERS—Full wave, may be used for replacement, or in construction of all types of test equipment—\$1.25. Half Wave—90c.

LINE FILTERS—110V—each unit contains two 2 mfd. oil filled condensers and a 15 amp. iron core choke. This filter has innumerable uses such as oil burner line filter, etc. A ten dollar value for 98c. Crystal pick-up, phono motor and turntable—\$5.25.

PUBLIC ADDRESS AMPLIFIERS—15 Watts peak output, 5 tubes, separate control for Microphone and Phono Input. \$65.00 value for only \$32.00.

WIRE—No. 18 POSI 2 conductor parallel zipcord, brown, 250 ft. spools, \$4.25; 500 ft. spools, \$7.95; No. 18 PO brown rayon covered parallel lampcord, 500 ft. spools, \$7.95; No. 18 SV round rubber covered double wire for wash machines, vacuum cleaners, etc., 250 ft. spools, \$6.95; Rubber covered mike cable, 66 per foot; R8B 50 ohm coax cut to any length, 8c per foot; single stranded conductor shielded lead with brown rubber over shield, super special, \$1.20 per 100 ft. \$10.00 per 1000 ft. All kinds of hook-up wire, 1c per foot.



MICROPHONES—All nationally known brands. Bullet crystal—\$5.45; Bullet Dynamic—\$7.45; Mike Jr.—60c; Handy Mike—90c; Lapel Mike—93c; SHURE T-17 MIKES, with push to talk switch—99c.

20 ASS'D COIL FORMS, including 11 ceramic, 3 polystyrene, and 6 fiber, all useful sizes—50c.

VARIABLE CONDENSERS: 350 MMFD, 5 gang—\$1.95; 4 gang—\$1.49; 3 gang—83c; 2 gang—79c; 7.5 to 20 MMFD, 1750v spacing, extra long shaft Hammarlund—69c; miniature variables, 25 MMFD—39c; 50 MMFD—49c; 75 MMFD—59c; 100 MMFD—69c; 140 MMFD—79c.

TRANSMITTING RF CHOKES, 4 PIE. 350 Ma.—25c or 5 for \$1.00.

INTERRUPTION FREQUENCY COILS for super-regenerative receivers or the tremendously popular FM adapters for standard broadcast sets. Iron core with a resonant frequency of 50 KC—39c; Air Core, 110 KC—29c.

30 MC IF TRANSFORMERS, double slug tuned—25c.

VIDEO AMPLIFIER PLATE COILS—Slug tuned—25c.

REMOTE CONTROL UNIT: Aluminum case 4x3x2" containing 2 potentiometers, triple pole switch, 4 knobs, gear mechanism, counter and phone jacks—59c.

MODULATION TRANSFORMERS—10 watt, metal case 98c; 30 watt, open type—\$1.95; 40 watt, cast aluminum case, \$2.95; Class "B" input transformers, cast aluminum case, \$1.95; Transceiver audio transformers, 65c; Transceiver modulation transformers, 65c.

TECHNOTES

... PHILCO CHANGERS

Failure of the reject mechanism on Model 35-1285 and 35-1289 record changers is due to failure of the slug in the reject solenoid to return to the correct position. This slug should be lengthened by unscrewing its two parts that are held together by threads.

A. W. POWELL,
Rolfe, Iowa

... SILVERTONE 7036

Flickering dial lamps and fading are usually caused by loose rivets holding the sockets to the chassis. One side of the heater circuit returns to the chassis through one of the rivets on each socket. To remedy this complaint, solder a wire from each socket return directly to the chassis.

STANLEY A. KUBIT,
La Porte, Ind.

RADIO-CRAFT wants *Technotes* describing common troubles of well-known receivers or telling how rare or difficult problems were solved. A six-month subscription will be awarded for each unillustrated and a one-year subscription for each illustrated *Technote* published.

... CHEVROLET 985695

These sets have been found to develop severe noise when the car is accelerating or being driven over a rough road. In three out of four cases, I have traced the trouble to a broken lead on the tone-control condenser. This condenser is located below the tone control switch and is connected from one side of the latter to the grounded side of the volume control. The break often occurs on the switch side of the condenser and is not easily detected during a visual inspection.

JOHN W. FINDARLE,
Modesto, Calif.

... SIGNAL TRACER

I constructed the signal tracer described on page 756 of the August, 1946, issue of RADIO-CRAFT. It would motorboat when the gain control was advanced. I checked the circuit and found that a 50,000-ohm resistor and a 0.05- μ f condenser were used as a decoupling filter in the plate circuit of the 6Q7-GT. I replaced the condenser with a 10- μ f, 450-volt electrolytic and my troubles were over. Now the tracer works perfectly at all volume levels.

G. ABLEMAN,
Edgerton, Wis.

... HUM REDUCTION

Recently I came across a set with a severe case of hum that was eventually traced to the converter stage. This stage used a thin wafer socket. The hum was caused by high-resistance leakage between the filament and grid prongs. Replacement with a socket of the molded bakelite type cleared up the trouble completely.

J. DUBOVY,
Bronx, N. Y.

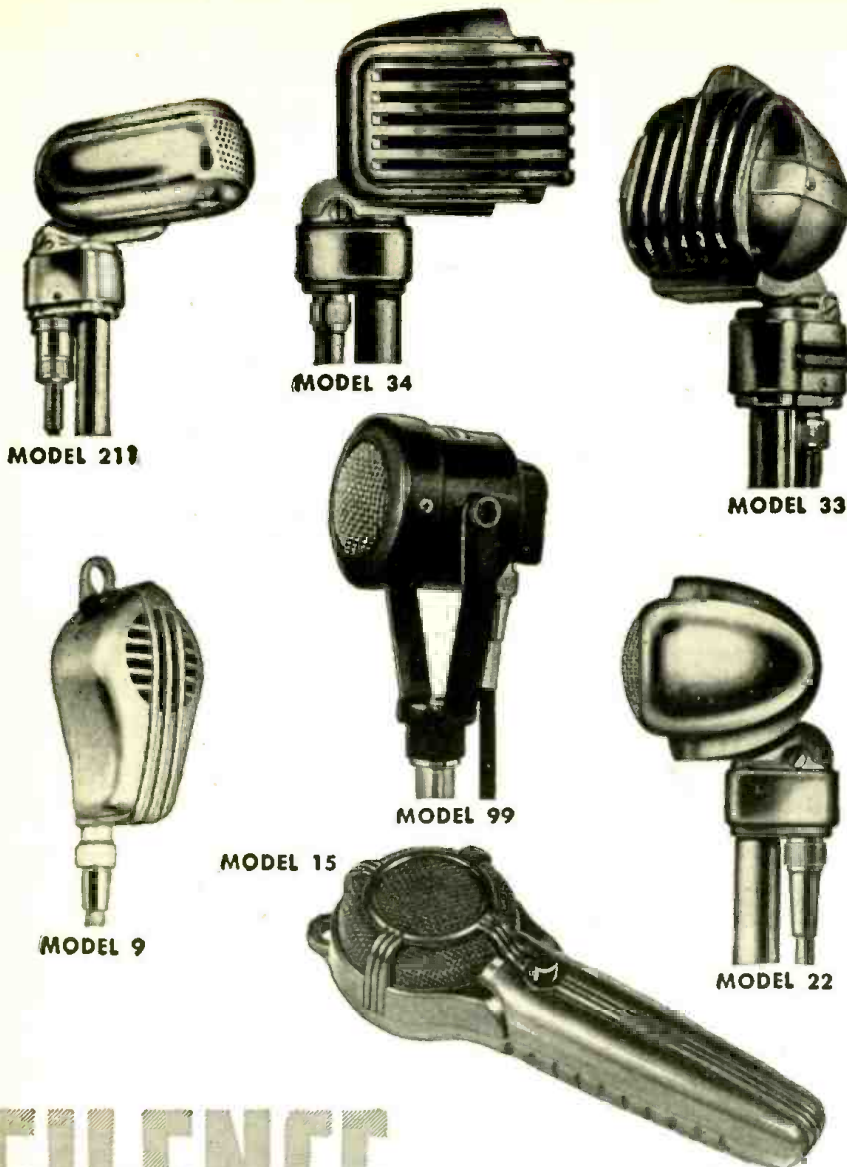

SILENCE SOUND IS GOLDEN

WITH MICROPHONES BY TURNER

The smooth performance and rugged dependability of Turner Microphones are the result of sound engineering, highest quality materials, and faultless workmanship.

For voice and music, for voice alone, or for any special sound application rely on Turner for greater satisfaction. Turner engineers will be glad to make impartial suggestions as to the right type microphone for your particular job.

ASK YOUR DEALER OR WRITE

THE TURNER COMPANY

902 17th Street N. E. • Cedar Rapids, Iowa

TURN TO TURNER—THE PASSWORD TO SOUND PERFORMANCE

LICENSED UNDER U. S. PATENTS OF THE AMERICAN TELEPHONE AND TELEGRAPH COMPANY, AND WESTERN ELECTRIC COMPANY, INCORPORATED. CRYSTALS LICENSED UNDER PATENTS OF THE BRUSH DEVELOPMENT CO.

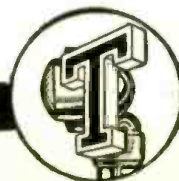

... SILVERTONE 4500

When hum in these sets is not traceable to condensers or tubes, try replacing the volume control. This control may open at one end while still controlling the volume effectively.

STANLEY A. KUBIT,
La Porte, Ind.

... 1LE3 IN PORTABLES

The 1LE3, used in many portables, can be replaced with a 1LH4 if the No. 4 (diode plate) pin is clipped off. When this tube is substituted for the 1LE3 in oscillator circuits, it will often provide clearer reception and lower noise level.

JOSEPH H. BLACHE,
Denver, Colo.

... WEAK R.F. AND I.F. AMPLIFIERS

Failure of i.f. and r.f. amplifiers is sometimes due to moisture in the coil assemblies. I remove the coils and dip them, padders up, in a can of hot paraffin. The heat dries out the padders, and the paraffin drives the moisture out of the coils and seals them against the effects of dampness. It is wise to tie the coils to the forms to prevent them from slipping while in the paraffin.

W. E. HARDIN,
Paintsville, Ky.

... ALIGNING KINK

It has been my experience, when aligning sets with two or more i.f. stages, that the set will approach ideal alignment only to break into oscillation as the stages are brought into resonance. I find that by applying degeneration to each stage this problem is eliminated. Disconnect the cathode by-pass condensers of the i.f. stages and remove the grid returns for these stages from the a.v.c. line or ground and connect them to the cathodes, leaving the condensers disconnected. This reduces the sensitivity enough to check oscillation. Upon completing the alignment, replace the original connections and the sensitivity of the set will return to normal.

J. W. ESSEX,
Halifax, N. S.

... SHORTED CONDENSERS

We all know how disconcerting it is to have to repair a radio in which the tuning condenser is warped and the plates scraping. Sometimes only one outside plate may be shorting and we can see this and correct it. At other times the plate may be in the center and not visible. My method is to disconnect the r.f. coil leads—only one is really necessary—and place a single dry cell across the section of the condenser which is causing the trouble. As the shaft is rotated, a distinct spark will be seen at the point or points of contact. Any sort of tool then may be used to straighten the plate. There are times when a spark may not be seen, but on careful examination after the condenser is out of mesh, a dark blemish on the rotor plate may be seen. This, of course, is caused by the current flowing across the plates when contact is made, with the plates so closely meshed that no spark results.

GEORGE E. HUFF,
Miami, Oklahoma

new

CONCORD Radio Catalog



Radio Parts Radio Sets Ham Gear Amplifiers

free
Radio Hams • Servicemen • Engineers
Sound Men • Maintenance Men
Schools • Institutions • Manufacturers
THIS CATALOG IS FOR YOU!
Mail **COUPON TODAY!**

Industrial Electronic and Test Equipment

It's here—ready for you now—the new, comprehensive, 1947 Concord Catalog displaying a vast, complete selection of everything in Radio and Electronics. Send for your copy now. Select your needs from value-packed pages showing thousands of items available for IMMEDIATE SHIPMENT—hundreds of them now available for the first time—featuring new, latest 1947 prices. See the new LOWER prices on finest-quality RADIO SETS, PHONO-RADIOS, RECORD CHANGERS, RECORD PLAYERS, PORTABLES, AMPLIFIERS, COMPLETE SOUND SYSTEMS, TESTERS. See complete latest listings of all the well-known, standard, dependable lines of radio parts and equipment—tubes, condensers, transformers, relays, resistors, switches, speakers—all available for IMMEDIATE SHIPMENT from huge stocks in CHICAGO and ATLANTA. Whatever your needs in Radio and Electronic Parts, Supplies and Equipment—before you buy—SEE THIS GREAT NEW CONCORD CATALOG. Mail coupon for your FREE copy now.



CONCORD
RADIO CORPORATION
CHICAGO 7 ★ ATLANTA 3
901 W. JACKSON BLVD. 265 PEACHTREE ST.
LAFAYETTE RADIO

Concord Radio Corporation, Dept. RC-77
901 W. Jackson Blvd., Chicago 7, Ill.
Yes, rush FREE COPY of the comprehensive
new Concord Radio Catalog.

Name

Address

City State



Question Box queries will be answered by mail and those of general interest will be printed in the magazine. A fee of 50c will be charged for simple questions requiring no schematics. Write for estimate on questions that may require diagrams or considerable research.

TUBE CHECKER

I would like to have a diagram of a tube checker that can be used for making mutual conductance as well as emission tests.—E.W.Z., Harrisburg, Penna.

A. The tester diagrammed provides a means of making mutual conductance and emission tests and will also check a tube for interelectrode shorts. It may be calibrated by testing tubes of known quality and recording the meter reading and control settings.

Emission tests are made by connecting the cathode and one side of the heater or filament to the lower bus and all other elements to the upper bus. The remaining heater connection is made to the center bus. The total current is taken as an indication of tube quality.

When making mutual conductance

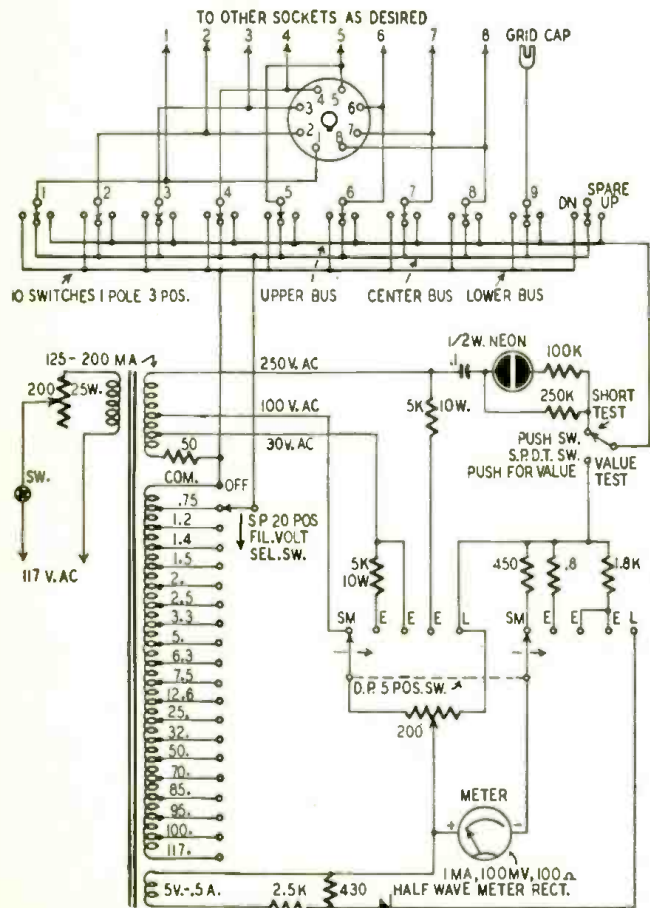

SM: TRANSCONDUCTANCE; E: EMISSION; L: LINE CHECK

tests, the cathode and one side of the filament and control and suppressor grids are connected to the lower bus, the other heater to the center bus and plate and screen leads to the upper bus.

SERVO AMPLIFIER

I have purchased a surplus servo amplifier using a pair of 7C5's, a 7F7, and a 7Y4. The power transformer is designed to work from a 110-volt 400 cycle power source. Can this be used? I would like to have a diagram showing how these parts may be used in a single-ended phono amplifier. Is it possible to use the 7F7 as a mixer so that I can use a T-17 surplus microphone, at the same time that I am playing the phonograph.—F.E., New Britain, Conn.

A. The diagram is shown. The T-17 is a single-button carbon microphone fitted with a special type plug. A Mallory type JK-33-A 3-circuit mike jack should be used on the amplifier panel. Voltage for the mike is obtained by tapping the 7C5 cathode resistor. The microphone transformer should be designed for coupling a 200-ohm single-button microphone to a grid.

The 400-cycle power transformer cannot be used on 60-cycle a.c. and

should be replaced by a standard unit supplying 285 to 300 volts each side of center tap at 75 to 100 ma. Use either a speaker field or filter choke.

ELECTRONIC TIMER

I would like to have a circuit of an electronic timer with a timing range of from about 1/10 of a second to 2 seconds. The device is to operate from a 117-volt d.c. line.—J.I.C., New York, N. Y.

A. An electronic timer is shown. The duration of the time cycle is determined by the setting of the 5-megohm time control and the capacity of its associated condenser. The values shown should give the required range. The 4-μf

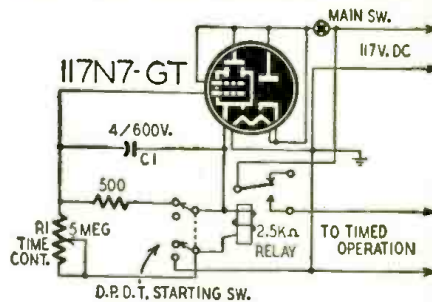

condenser C1 should be a low-leakage paper or oil-filled type. The condenser and time control should be mounted on low-loss material so that the time constant will not be disturbed. The 2,500-ohm relay should be equipped with s.p.d.t. contacts, with either circuit-opening or circuit-closing action.

If other time ranges are desired, an increase in the value of R1 or C1 will increase the length of the cycle.

A 50L6 or 25L6 may be used if a filament-dropping resistor is used.

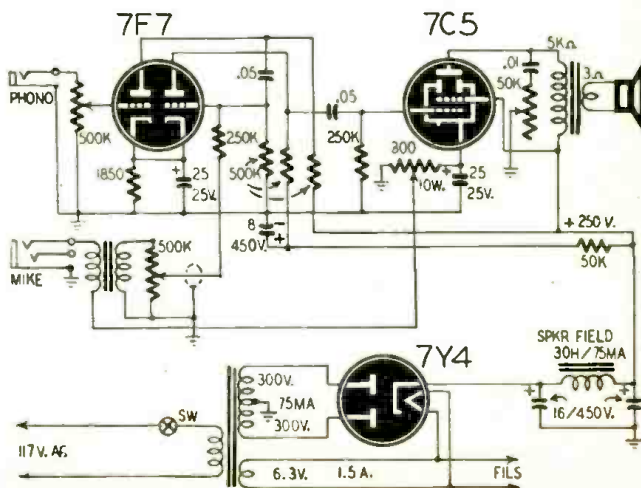

CUSTOMERS AND LAUGHS

Customers are the queerest of animals, yet without them we not only would starve but would miss out on a good many hearty laughs in life. Some of the incidents which have been most annoying to me, yet amusing, follow:

A very irate customer appeared at the wicket one day asking for the manager of the department. Upon my appearance he let forth with a strange language which made even my hardened ears burn. From what I could piece together of the conversation I gathered that the d --- tubes that he bought from us were no d --- good. They would work not too badly on 1 1/4 volts (for which they were intended) and on 4 volts they played a little louder, but when 6 volts was applied they didn't play at all, and he wanted a refund.

Another customer placed an order for a new grid leak for his radio. He knew that the old one in his set was defective as there was no sign of moisture under it!

A new car radio was brought back under warranty service for repairs. Upon inspection the top of the vibrator can was found to be cut off. When the customer was questioned he admitted performing the operation with a can opener "to find out what was rattling inside."

Then there is the customer who complains, "My radio hasn't played a day since it was repaired" (especially if you are trying to collect an overdue account). Upon investigation you find all the trimmers of the i.f. transformers tightened down and half the parts missing.

Servicemen are turning gray overnight trying to convince the public that the trouble is not necessarily in the speaker because it won't speak.

The following telegrams add to the fun. "Rush two 6V67-GT tubes." Upon advice of "No such tube," reply came, "Rush instead two 6K67-GT tubes." The second time advice went "No such tube," and the reply came, "Rush instead two 6K6-GT tubes." These were forwarded, to be received back the next day with the following notation, "These do not fit set, please rush two 6JK7-GT tubes." Just about then some customer has to wander in and demand a condenser for a 1937 Victor radio.

Put everything together and radio servicing is still a great trade despite the customers.—Raymond E. Wice

INEXPENSIVE CHASSIS

To make a cheap, neat-looking chassis, take a cigar box and drill into it the necessary holes for mounting sockets and other parts. Cover the box with masking tape and punch through the previously cut holes. Excess tape is pulled through the holes and fastened to the underside of the box. Black cloth bookbinders' tape also makes a neat-looking job.

ALLEN J. SCHWARTZ,
Albany, N. Y.

LET THIS "AUTOMATIC TEACHER" show you exactly how to repair over 4800 RADIO MODELS without expensive test equipment!

GHIRARDI SAVES YOU TIME —HELPS YOU MAKE MONEY

Ghirardi's RADIO TROUBLESHOOTER'S HANDBOOK is the ideal manual to show you exactly how to repair radios at home in spare time—quickly and without a lot of previous experience or costly test equipment. It contains MORE THAN 4 POUNDS OF FACTUAL, time-saving, money-making repair data for repairing all models and makes of radios better, faster and more profitably than you may have thought possible!

NOT A "STUDY" BOOK

RADIO TROUBLESHOOTER'S HANDBOOK can easily pay for itself the first time you use it. You don't have to study it. Simply look up the make, model, and trouble symptom of the Radio you want to repair and go to work. No lost time! Clear instructions tell exactly what the trouble is likely to be—EXACTLY how to fix it. Actually, this big 744-page manual-size HANDBOOK brings you factual, specific repair data for the common troubles that occur in practically every radio in use today—for over 4800 most popular models of Home and Auto radio receivers and Automatic record changers of 202 manufacturers! In addition, there are hundreds of pages of helpful repair charts, tube charts, data on tuning alignment, transformer troubles, tube and parts substitution, etc., etc.—all for only \$5 (\$5.50 foreign) on an UNRESERVED 5-DAY MONEY-BACK GUARANTEE!

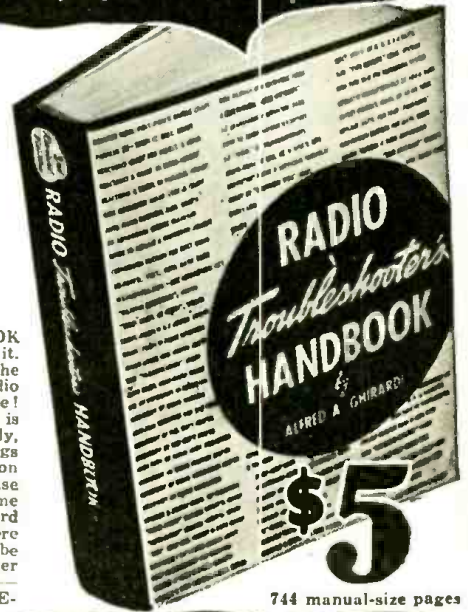

Get a Complete RADIO-ELECTRONIC SERVICE EDUCATION AT HOME—WITHOUT AN INSTRUCTOR

COMPLETE DATA ON TEST INSTRUMENTS —TROUBLESHOOTING—REPAIR



1300 pages, 706 illus.
723 review questions

A. A. Ghirardi's big 1300-page MODERN RADIO SERVICING is the finest, most complete instruction book on Radio-Electronic service work for either the novice or the professional Radio-Electronic serviceman—bar none! Read from the beginning, it is a COMPLETE COURSE IN SERVICING by the most modern methods. Used for reference, it is an invaluable means of brushing up on any servicing problem. Gives complete information on all essential service instru-

ment types; how they work (with wiring diagrams), when and why to use them; how to build your own; preliminary trouble checks; circuit and parts analysis; parts repair, replacement, substitution; obscure radio troubles; aligning and neutralizing; interference reduction—and hundreds of other subjects including How to Start and Operate a Successful Radio Electronic Service Business. 723 self-testing review questions help you check your progress EVERY STEP OF THE WAY. Only \$5 complete (\$5.50 foreign).

5-DAY MONEY-BACK GUARANTEE

Technical Division, MURRAY HILL BOOKS, INC.,
Dept. RC-77, 232 Madison Ave., New York 16, N. Y.

Enclosed find \$..... for books checked or send C.O.D. (in U.S.A. only) for this amount plus postage. If not fully satisfactory, I may return the books at the end of 5 days and receive my money back.

- MODERN RADIO SERVICING \$5 (\$5.50 foreign)
- RADIO TROUBLESHOOTER'S HANDBOOK \$5 (\$5.50 foreign)
- Special MONEY-SAVING COMBINATION Both big books for only \$9.50 (\$10.50 foreign)

Name
Address
City & Dist. No. State.....
(Please print or write plainly)

You Can't Go Wrong on a Ghirardi Radio Book!

MONEY-SAVING OFFER! Get BOTH big books — Radio's most famous Service Library — over 2000 pages — at a bargain combination price. See coupon.

ANNOUNCING

...New OHMITE 5-Watt BROWN DEVIL RESISTORS



WIRE-WOUND
VITREOUS-ENAMELED
TYPE

Provide Utmost Dependability
in a New Small Size

Now you can get an Ohmite wire-wound vitreous-enameled resistor... of proved reliability... in the 5-watt size. This new resistor has the same rugged construction... the same unflinching dependability... as larger Ohmite industrial units. Yet it is small enough to fit practically any installation. Easily mounted by its 1½-inch, tinned copper-wire leads. Tolerance $\pm 10\%$. Available in a wide range of resistance values. Where you need a small resistor that you can install and forget—use this new Ohmite unit.

OHMITE MANUFACTURING CO.
4894 Flourney Street Chicago, Illinois

NEW Ohm's Law Calculator



A new and improved handy pocket size (9" x 3") calculator. All computing scales are on one side. Shows RMA resistor color code. Mail 25c in coin for your copy.



Be Right with...

OHMITE
RHEOSTATS • RESISTORS • TAP SWITCHES

New Radio-Electronic Patents

By I. QUEEN

VOLTAGE REGULATION

James A. Potter, Rutherford, N. J.
(assigned to Bell Telephone Labs., Inc.)
Patent No. 2,413,033

A thermistor is a simple element whose resistance changes with a change in temperature. This makes it useful as a voltage or current regulator or control unit. In this power supply two thermistors are used to maintain an output voltage which is constant within very narrow limits.

Thermistor A is connected across an auxiliary secondary winding to maintain its operating temperature near the optimum value. If the load increases more current flows through A and there is a tendency for the voltage of the system to drop. The increased current reduces the resistance and voltage drop across the thermistor.

Therefore the output change is compensated for.

Thermistor B is connected in a circuit which shunts the output. If the load increases as before, the voltage across the shunt circuit tends to drop off and therefore the thermistor voltage will be lower. This corresponds to an increase in current through B and through the heater H of A. The indirect heating of A adds to its control effectiveness and practically eliminates any change in the output voltage.

Although it is desirable that the shunt circuit current undergo a large change for small load changes, this effect in itself constitutes a change in the effective load of the power supply, which in itself would oppose good regulation.

The problem is solved by including a variable resistor R and a negative-coefficient resistor N (such as silicon carbide) in the shunt circuit. When the variable resistor is correctly adjusted, the sum of voltages across the components will be practically constant over the operating current range.

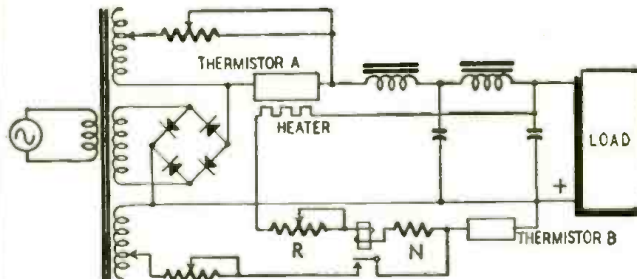

IMPROVED SUPERREGENERATOR

Joseph A. Worcester, Jr.
(assigned to General Electric Co.)
Patent No. 2,410,768

The superregenerative circuit is deservedly popular for reception of u.h.f. signals. It combines broad tuning (for wide-band modulation), extremely high sensitivity and simple design. Positive feedback is used to provide enormous amplification but sustained oscillations are prevented by periodically damping or interrupting the circuit. In its simplest form, the superregenerator includes its own means of quenching or interruption. Feeble oscillations are rapidly built up until the grid becomes sufficiently positive to attract an appreciable quantity of electrons. This charge is trapped because of a very large grid resistor. The negative bias then cuts

off plate current until the charge can leak off.

Because of the inoperative periods required for a charge to leak off, the modulation frequency which can be received without distortion is much lower than the interruption rate. In the self-quenching circuit the latter ordinarily may be made as high as 50 kc by proper design of grid constants R and C. Therefore the circuit will distort FM or video signals, which have very wide modulation bands. This new circuit permits increasing the upper quenching limit to approximately 1 mc, thus making it suitable for television and other wide-band signals.

Few additional components are necessary. The

oscillator grid leak is composed of two resistors, R and S. Resistor S is about 1 megohm and is much larger than resistor R. The grid cathode of tube T is connected across S. Ordinarily the tube is nonoperative because of the cathode bias produced at S, but when oscillator grid current flows through this resistor the tube conducts. This short-circuits S and permits a rapid discharge of the electron accumulation on the oscillator grid.

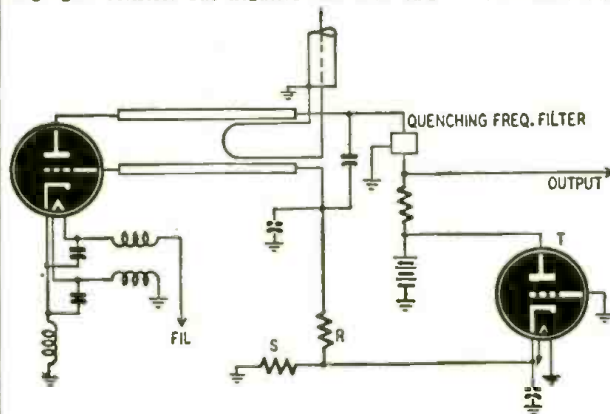

SUB-HARMONIC GENERATOR

Stuart W. Seeley
(Assigned to Radio Corp. of America)
Patent No. 2,403,559

It is often inconvenient to generate a desired frequency directly, so either multiplication or division must be resorted to. Frequency multiplication is a natural process since any distorted wave contains harmonics and it is only necessary to pick out the required one. Special cir-

cuits may be designed to generate sub-harmonics.

In this circuit sub-harmonics are generated by suppressing portions of the fundamental wave. For example, the third sub-harmonic is obtained by suppressing two cycles and permitting only

(Continued on page 73)

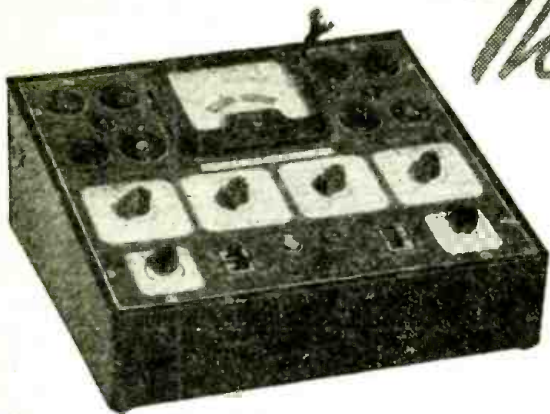

The New Model 60-T TUBE and SET TESTER

A COMPLETE TUBE TESTER

Tests all tubes including the new post-war miniature loctals such as the 12AT6, 12AU6, 35W4, 50B5, 117Z3, etc. • Tests by the well-established emission method for tube quality, directly read on the scale of the meter • Tests shorts and leakages up to 3 Megohms in all tubes • Tests leakages and shorts of any one element against all elements in all tubes • Tests both plates in rectifiers • Tests individual sections such as diodes, triodes, pentodes, etc., in multi-purpose tubes.

Model 60-T operates on 90-120 Volts 60 Cycles A.C. Housed in sloping leatherette covered cabinet. Comes complete with test leads, tube charts and detailed operating instructions.

EXTRA: WE CAN NOW SUPPLY THE MODEL 60 HOUSED IN A BEAUTIFUL HAND-RUBBED OAK CABINET. COMPLETE WITH PORTABLE COVER MAKING IT SUITABLE FOR EITHER BENCH OR OUTSIDE USE. ONLY \$2.75 ADDITIONAL. SPECIFY MODEL 60-C.

A COMPLETE MULTI-METER

- 6 D.C. Voltage Ranges: 0 to 7.5/15/75/150/750/1,500 Volts
- 6 A.C. Voltage Ranges: 0 to 15/30/150/300/1,500/3,000 Volts
- 4 D.C. Current Ranges: 0 to 1.5/15/150 Ma. 0 to 1.5 Amps.
- Low Resistance Range: 0 to 2,000 Ohms (1st division is 1/10th of an ohm.)
- 2 Medium Resistance Ranges: 0 to 20,000/200,000 Ohms
- High Resistance Range: 0 to 20 Megohms
- 3 Decibel Ranges: -10 to +38 +10 to +38 +30 to +58 D.B.

\$49⁸⁵
NET PRICE

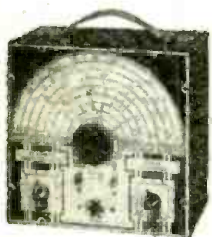

THE NEW MODEL B-45

SIGNAL GENERATOR

Complete, ready to operate. . . . **\$27⁷⁵**

Self-modulated — provides a highly stable signal. RF frequencies from 150 Kc. to 12.5 Mc. on Fundamentals and from 11 Mc. to 50 Mc. on Harmonics.

Modulation is accomplished by grid-blocking action — equally effective for alignment of amplitude and frequency modulation as well as for television receivers. Self-contained batteries. All calibrations are etched on the front panel, permitting DIRECT READING.

Model B-45 uses a beautifully processed dualtone front panel. Comes housed in a heavy-gauge crystalline steel cabinet complete with shielded test lead, self-contained batteries and instructions.

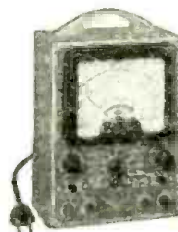

THE NEW MODEL 670

SUPER METER \$28⁴⁰

A Combination VOLT-OHM-MILLIAMMETER plus CAPACITY REACTANCE, INDUCTANCE and DECIBEL MEASUREMENTS

D.C. VOLTS: 0 to 7.5/15/75/150/750/1500/7500.
A.C. VOLTS: 0 to 15/30/150/300/1500/3000 Volts.
OUTPUT VOLTS: 0 to 15/30/150/300/1500/3000.
D.C. CURRENT: 0 to 1.5/15/150 Ma.; 0 to 1.5 Amps.

RESISTANCE: 0 to 500/100,000 ohms 0 to 10 Megohms.
CAPACITY: .001 to .2 Mfd., .1 to 4 Mfd. (Quality test for electrolytics).
REACTANCE: 700 to 27,000 Ohms; 13,000 Ohms to 3 Megohms.
INDUCTANCE: 1.75 to 70 Henries; 35 to 8,000 Henries.
DECIBELS: -10 to +18, +10 to +38, +30 to +58.
The Model 670 comes housed in a rugged, crackle-finished steel cabinet complete with test leads and operating instructions. Size 5 1/2" x 7 1/2" x 3".



THE NEW MODEL CA-11

SIGNAL TRACER \$18⁷⁵

Simple to operate . . . because signal intensity readings are indicated directly on the meter!

- ★ SIMPLE TO OPERATE — only 1 connecting cable — NO TUNING CONTROLS.
- ★ HIGHLY SENSITIVE — uses an improved Vacuum Tube Voltmeter Circuit.
- ★ Tube and resistor-capacity network are built into the Detector Probe.

- ★ COMPLETELY PORTABLE — weighs 5 lbs. and measures 5" x 6" x 7".
- ★ Comparative Signal Intensity readings are indicated directly on the meter as the Detector Probe is moved to follow the Signal from Antenna to Speaker.
- ★ Provision is made for insertion of phones.

The Model CA-11 comes housed in a beautiful hand-rubbed wooden cabinet. Complete with Probe, test leads and instructions.



THE NEW MODEL 450

TUBE TESTER \$39⁵⁰

Speedy operation — assured by newly designed rotary selector switch which replaces the usual snap, toggle, or lever action switches.

SPECIFICATIONS

- Tests all tubes up to 117 volts.
- Tests shorts and leakages up to 3 Megohms in all tubes.
- Tests individual sections such as diodes, triodes, pentodes, etc., in multi-purpose tubes.
- New type line voltage adjuster.
- Tests microphonic tubes or noise due to faulty elements and loose internal connections.
- Uses a 4 1/2" square rugged meter.
- Works on 90 to 125 volts 60 cycles A.C.

EXTRA SERVICE — May be used as an extremely sensitive condenser Leakage Checker. A relaxation type oscillator incorporated in this model will detect leakages even when the frequency is one per minute.

OUR POLICY

We do not advertise any unit which is not available for immediate shipment from stock. • Less flowery adjectives, more detailed specifications. • All units are sold subject to one year guarantee except when components are damaged through misuse. • We do

not solicit orders for any unit that does not meet our requirements for accuracy and honest value. Any item purchased from us is sold with the understanding that it may be returned for full refund after a 10 day trial.

20% DEPOSIT REQUIRED ON ALL C.O.D. ORDERS

GENERAL ELECTRONIC DISTRIBUTING CO.

DEPT. RC-7, 98 PARK PLACE, NEW YORK 7, N. Y.

NEW

RADIO-ELECTRONIC DEVICES

TRANSMITTER CONTROL

Ward Leonard Electric Co.
Chicago, Ill.

Offered in kit form or completely assembled and wired, this new transmitter control panel is completely interwired and mounts directly on a standard relay

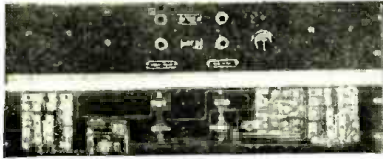

rack. It gives full automatic protection against damage to tubes, transformers, and other gear from overloads and power failures and provides finger-tip control of filament and plate supply. ON filament push button starts transmitter; ON plate button puts station on the air; OFF button interrupts transmission; and OFF filament button shuts down station.

The Ward panel includes 1 filament relay; double-pole, 15-ampere contacts; 1 plate relay, double-pole, 15-ampere contacts; 1 time-delay relay; one overload relay (250 or 500 ma); 2 push buttons each for filament and plate supply. Panel size is 3½ by 19 inches, with 1¾-inch maximum depth behind panel, furnished in gray or black crackle finish. For 115 volts, 60-cycle a.c.—RADIO-CRAFT

SIGNAL GENERATOR

Electronic Mfg. Co.
Harrisburg, Penna.

The Model 200 spot frequency generator features 12 preset frequencies chosen to cover adequately the most commonly used receiver test channels. Six switches are provided, with only a flip of a switch necessary to select or change to any desired frequency. Spot frequencies are: 175, 262, 370, 455, 456, 600, 1000 and 1400 kc and 2, 5, 7.5, and 20 mc. A single output jack makes it unnecessary to switch test leads.



Stability is maintained by an electron-coupled circuit and low leakage is assured through use of double shielding. The generator attenuates to less than 1 microvolt. It is a.c. operated. The panel is of acid-etched aluminum with a steel case.—RADIO-CRAFT

LOW-VOLTAGE D.C. SUPPLY

Electro Products Laboratories, Inc.
Chicago, Ill.

The Electro Model A power supply is designed for use by servicemen on automobile, aircraft, and marine radio equipment operating from 6- or 12-volt d.c. supplies. It consists of two 6-volt, 7.5-ampere filtered d.c. power sources which can be placed in series to deliver 12 volts at 7.5 amperes or in parallel for 6-volt, 15-ampere operation.

The unit operates from 105-, 115-, or 125-volt, 60-cycle power sources and weighs 31 pounds.—RADIO-CRAFT

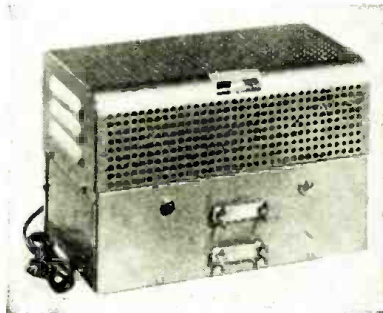

CRYSTAL RECTIFIERS

Western Electric Co., Inc.
New York, N. Y.

Silicon crystal rectifiers used in radio links, telephone apparatus, portable test equipment, and other electronic circuits where space, power consumption, per-

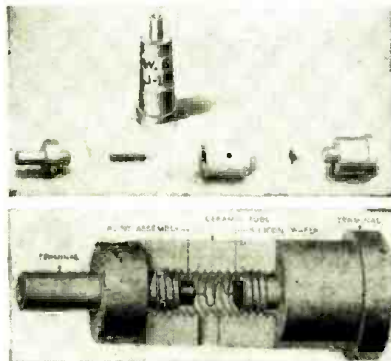

formance, and economy are paramount, are announced by the Western Electric Company. These include the 1N21B, 1N23A, 1N23B, 1N25, 1N26, 1N28, and 1N31. They are applicable as frequency converters, low-level detectors, and instrument rectifiers. In the unshielded type, a ceramic insulator separates the point and crystal wafer; in the shielded type, a metal shield encloses the structure. These types employ point contact with the rectifying element.—RADIO-CRAFT

R.F. PROBE

Radio Frequency Laboratories, Inc.
Boonton, N. J.

This new r.f. probe is designed for functional testing of high frequency circuits. When the probe is subjected to an r.f. field, a proportionate r.f. current is induced, rectified and indicated on a

Weston 506 meter. Useful for detection of standing waves, shielding power leaks, r.f. choke efficiency, and circuit tracing for r.f. in all radio frequency equipment and associated components, without affecting operation of the circuit. AM, FM and television transmitters up to 1500 megacycles, electronic heating and soldering equipment, antennas and transmission lines, and other r.f. units can be checked throughout. It is valuable in seeking out causes of lowered operating efficiency, damage or interference to neighboring equipment and components, spurious radiation and escape of r.f. into power lines.

Probe element is ¼ inch in diameter, 5 inches long.—RADIO-CRAFT

MAGNETIC CUTTING HEAD

Fairchild Camera and Instrument Corp.
New York, N. Y.

A new magnetic recording head complete with equalizer and standard mounting plate and suitable for any current model sound recorder is Fairchild's Unit 541A. It is designed to meet the standards of FM and AM broadcast and professional recording.

The unit has a guaranteed frequency response of ±2 db over a range of 30 to 8,000 cycles with less than 1 percent distortion at 400 cycles. Its construction provides for adjusting and maintaining the alignment of the armature without

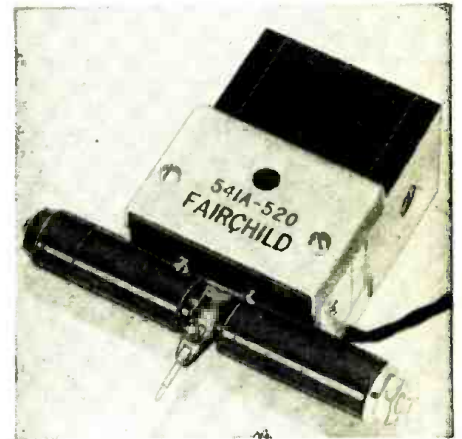

disassembling the cutting head. The cutting head has a 500-ohm impedance and requires a 0.6-watt + 20-db power level. A stylus ⅝ inch long and 0.062 inch in diameter is used.—RADIO-CRAFT

ALUMINUM VOICE COILS

General Electric Co.
Schenectady, N. Y.

The new GE loud-speakers have aluminum instead of paper bases for voice coils. It is claimed that this type of form can handle greater power, has longer life, is unaffected by temperature or humidity, and will not warp or crack. The aluminum-based voice coil also can be produced with better control on gaps.—RADIO-CRAFT

IMPROVING THE MIDGET RADIO

MANY midget t.r.f. and superheterodyne radios make excellent tuners for record players and phono amplifiers. By using a large well-baffled speaker and possibly a tone-compensated amplifier, high-grade console radio performance may be enjoyed.

When converting the radio to a tuner, all power supply and amplifier components are removed. In most cases, the filament and high-voltage circuits of the r.f. section consume comparatively little current and all voltages may be taken from the amplifier power supply with little danger of overloading. If the radio is an a.c.-d.c. model, the filaments are connected in series. In this case, they should be connected in parallel and the leads brought to the filament prongs of the output tube socket, into which the power-supply plug from the amplifier is to be plugged. The cathode terminal of this socket is grounded to the chassis and is the tie-in point for the B-minus and common ground between the two units. The B-plus line in the tuner is connected to the plate terminal as the high-voltage input terminal.

A 0.05- μ f, 600-volt blocking condenser is connected between the output of the detector (or the plate of the first audio stage if a diode-triode is used) and the grid terminal of the output socket. This

terminal is connected to the input terminals of the amplifier. (It is advisable to shield the input lead since it may pick up hum from filament leads and other sources.)

The midget receiver itself may be improved by installing it in a baffle cabinet to extend its audio frequency range.

The bass response of many speakers can be improved through proper baffling. Where a suitable speaker enclosure or console cabinet is unavailable, efficient baffles can be built into bookcases, cabinets, radiator enclosures, and other household furnishings. A drawing of a suitable baffle is shown in the figure. (The front and back panels are not shown in the drawing, dotted lines show vent and speaker openings.) For improved appearance the unit is designed to be enclosed within some sort of case or cabinet. The case shown is assembled from celotex panels either $\frac{1}{2}$ or $\frac{3}{4}$ inch thick. Screws and glue are used on the

assembly. The inside ports are 3 by 10 inches. Dimensions of the vent vary directly as the speaker size. Values given are for a 12-inch speaker.

This baffle, of course, will not help an overloaded speaker, a frequent source of distortion in midgets. If volume is kept down, however, it will produce a startling improvement in the quality of any midget. In such a case the midget is mounted right inside the baffle (after removing the cabinet). Speaker and vent holes are scaled down to

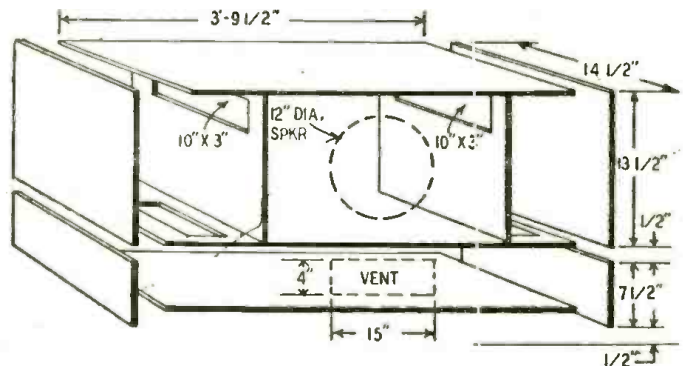

A simple baffle of this type improves midget quality startlingly.

proper size and, where desirable, all dimensions can be decreased, with some sacrifice of low-note response.—John Kwietniskas

Most Often Needed
1947
RADIO DIAGRAMS
and Servicing Information
M. H. REIZMAN
SUPREME PUBLICATIONS
CHICAGO

SUPREME PUBLICATIONS

New 1947 Radio DIAGRAM MANUAL

Only \$2.00

GET ALL 7 VOLUMES NOW

Amazing Bargain Offer

Speed up and simplify all radio repairs with the inexpensive SUPREME Manuals. Service radios faster, better, easier, save money and time, use these most-often-needed diagram manuals to get ahead and earn more per hour. At unbelievable low cost (only \$2 for most volumes) you are assured of having in your shop and on the job, needed diagrams and other essential repair data on 4 out of 5 sets you will ever service. Every popular radio of every make, from old-timers to new 1947 sets, is included. Clearly printed circuits, parts lists, alignment data, and helpful service hints are the facts you need to improve your servicing ability. Save hours each day, every day, let these seven volumes furnish diagrams for 80% of all sets. See pictures of these attractive manuals above. Each volume has between 192 and 240 pages, large size 8 1/2 x 11 inches. Manual style binding. Send coupon today.

NO RISK TRIAL ORDER COUPON

SUPREME PUBLICATIONS, 9 S. Kedzie Ave., Chicago 12, ILL.
Ship the following manuals: (Money back guaranteed)

1947 1946 1942 1941 1940 1939 1926-1938

Price each volume only \$2.00, postpaid \$2.50

- I am enclosing \$..... send postpaid.
 Send C.O.D. I am enclosing \$..... deposit.

Name:

Address:

(Send coupon or write order in a letter)

HIGHBRIDGE'S BEST BUY NEW DYNAMIC TELEVISION KIT

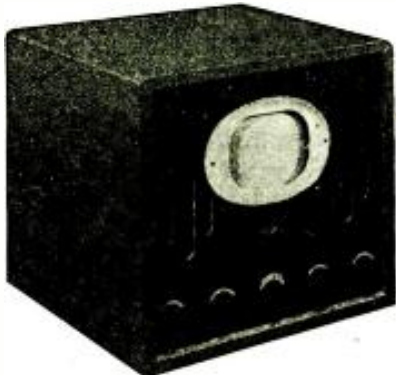

COMPLETE
With Tubes—Parts—
Leatherette Cabinet
\$159.50
Exclusive Mail Distributors

Check These Outstanding Features:

- Three stages of video I.F. amplification—3.5 MC bandwidth.
- Receiver may be aligned easily without use of signal generator.
- Complete resistance and voltage analysis chart for easy trouble shooting supplied with each kit.
- If transformers are slug tuned for high gain and maximum efficiency.
- Safety interlock switch supplied with each unit.
- Simplicity of operation—only 5 controls on front panel.
- Schematic diagrams are broken down into simple circuits for ease in wiring.
- Picture is very stable—does not jump or tear out even under unusual receiving conditions.
- 4 Channels—provisions for six.
- Seventeen tubes including large picture tube.
- Picture tube is seven inches in diameter and gives a picture 26 square inches in size.
- All parts are unconditionally guaranteed to be electrically and mechanically perfect.

Set comes complete with all necessary information sheets, parts, drilled and punched chassis, beautifully finished front panel and modernistic cabinet. Hardware and other necessary items are also included. **NOTHING ELSE TO BUY.** Above kit complete with solid mahogany, walnut or birch cabinet, as illustrated.



SELECTION SILENIUM RECTIFIERS

50 to 99	.85	
6 to 49	.90	
1 to 5	.99	

Quotations on larger quantities furnished upon request

USEFUL FOR: ★ AC-DC Portables ★ Intercom Power Supplies ★ Console Radios ★ Replaces 2D Types of Rect. Tubes

KN-9524—Transformer Pri. 115 V—60 cycles. Sec. #1—4.0 V @ 30 MA C.T. Sec. #2—8.4 V @ 1250MA. Rectangular metal case, stud mtg. solder eyes—approx size 3 1/16 x 2 5/16 x 3 3/8 with standoff 4 3/8.

No. T2G-97. Special. \$1.95

L.R. #7313 Filament Trans. 115 V—50-60 cycle. Sec. #1—27 KV @ 4.3 amps No. C.T.—Sec. #2—5.1 V @ 3 amp C.T.—Sec. #3—84 V @ 3 amp No. C.T.—Sec. #4—5.1 V @ 3 amp C.T.—Sec. #5—2.6 V @ 3.5 amps No. C.T.—Rectangular metal case, solder post terminals; Mtg on porcelain stand-off; stud mtg. size 5 3/8 x 4 3/8 x 3 3/8 with standoffs 6 3/8.

T2E-88. Special. \$4.95

NEW No. 631PI/SNA Glass Strobotron tubes. Each \$3.25
100 Bv-Pass Condensers, 10 Varieties. Special. \$4.95

115v voltage transformer with Glass Standoffs. Pri. 115 V. A.C.—400 cycle—Sec. 13,500 V. Rectangular; approx. size 6 3/8 x 4 3/8 x 3 3/8 with standoff 7 1/4—13 Mills D.C.

T3F-7. Special. \$3.95

TUBE			
12A6	.83	6SN7	.79
6SQ7	.83	6SJ7	.83
6AJ5	1.25	6C4	.79
1625	.70	5PB1	.595

All Prices FOB New York City, N. Y.
**HIGHBRIDGE RADIO - TELEVISION
& APPLIANCE CO.**
343 CANAL NEW YORK 13, NEW YORK

WORLD-WIDE STATION LIST

Edited by **ELMER R. FULLER**

SO far this summer conditions have not been very good, and very little real dx has been heard. Dx on the ham bands has been very good a few times, and several overseas countries have come in. Hams have been heard from Guatemala, Mexico, Puerto Rico, Canada, Swan Island, Guantanamo Bay, Barbados, Antigua, Haiti, Costa Rica, Newfoundland, Alaska, Panama, Bermuda, Jamaica, Canal Zone, Nicaragua, Montserrat (small island in the B. W. I.), British Honduras, Labrador, Honduras, Greenland, Martinique, Grenada, Dominican Republic, Bahama Islands, Saint Lucia, Virgin Islands, Trinidad, Brazil, Argentina, Ecuador, Uruguay, Colombia, Peru, Curacao, British Guiana, Chili, Venezuela, Paraguay, Dutch Guiana, Isle of Man, Wales, England, Scotland, Germany, Northern Ireland, Italy, France, Belgium, Luxembourg, Switzerland, Denmark, Norway, Irish Free State, Malta, Netherlands, Greece, Spain, Gibraltar, Portugal, Finland, Azores, Rumania, Sweden, Iceland, Sardinia Czechoslovakia, Austria, U. S. S. R., Algeria, Belgian Congo, Union of South Africa, Tangiers, Egypt, Northern Rhodesia, French Morocco, French West Africa, Liberia, Southern Rhodesia, Tanganyika, Mozambique, Gold Coast, Basutoland, Libya, Kenya, Hawaii, Guam, Australia, New Zealand, Canton Islands, Papua, Tasmania, Marshall Islands, Philippine Islands, Netherland Indies, Wake Island, Palmyra

Island, New Hebrides, Fiji Islands, Iwo Jima, China, Okinawa, Japan, India, Burma, Hedjaz, Iran, Aden, Iraq, Ceylon. This is certainly a good list of catches for 10- and 20-meter ham bands, and were all received on the East Coast. Many of these are easy to get, but several are considered very good dx, and some of them only have one, or very few hams located there. Send in a report on any of these hard-to-get ones you hear. We have more details on them, but space does not permit us to publish the full dope, so drop me a line on the ones you are interested in.

A station in the Soviet zone of Berlin is being operated on 6.070 megacycles, and is being heard often on the East coast. As yet we have not received a report of any call letters being used. Schedule is also unknown to us. OTC in Leopoldville, Belgian Congo, is being heard on 17.770 megacycles from 0500 to 0830 hours, and on 9.745 megacycles from 1030 to 2300 hours, EST. Programs in English are heard from 1030 to 1200 hours, 1530 to 1645 hours, and 2100 to 2300 hours. The last is beamed toward the United States, while the other two are directed to the Great Britain area.

In another month or so, the dx season will begin, and some better reports are expected. So make the best of it, and some very good dx can be picked up even in the warm summer months.

All schedules are Eastern Standard Time.

Location	Station	Freq.	Schedule	Location	Station	Freq.	Schedule	
UNITED STATES				All WWV frequencies broadcast time and musical pitch. All broadcast a 400-cycle note, and an additional 4,000 cycle note is sent on 5, 10, 15, 20 and 25 mc. Time is announced in code at 5-minute intervals, and voice announcements are made every half hour.				
Washington, D. C.	WWV	2.500	U.S. Bureau of Standards	U. S. S. R.				
	WWV	5.000	1900 to 0700 (440-cycle note only)	Kiev	11.720			
	WWV	5.000	0700 to 1900 (440 and 4,000-cycle note)	Komsomolsk	9.560	6100 to 6530; 1100 to 1500; 1545 to 1850; 1700 to 1830		
	WWV	10.000	Continuously	Moscow	5.810	schedule unknown		
		15.000						
		20.000						
		25.000						
		30.000						

RADIO TERM ILLUSTRATED



Frank BEAVEN

Suggested by: Michael Kosinski, Brooklyn, N. Y.

"A good multiplier"

Location	Station	Freq.	Schedule
Moscow		6.030	schedule unknown
Moscow		9.680	1000 to 1745; 2315 to 2345
Moscow		7.300	1300 to 1800; 1815 to 2100
Moscow		9.180	0000 to 0100; 0530 to 0815; 1100 to 1130; 1590 to 1700
Moscow		9.650	1100 to 1220; 2290 to 2255
Moscow		9.710	2300 to 0730
Moscow		9.850	2300 to 0200; 0430 to 0830; 1000 to 1200
Moscow		11.630	1930 to 0300; 0500 to 0800; 0830 to 1300
Moscow		11.780	0900 to 1000; 2000 to 2130; 2200 to 0100
Moscow		11.830	2200 to 0600; 0730 to 0845; 1100 to 1600
Moscow		11.880	0730 to 1900; 2200 to 0600
Moscow		12.080	0800 to 1100
Moscow		15.320	0000 to 0500; 0530 to 0800; 0830 to 1100; 2200 to 2300
Moscow		15.340	2200 to 0800; 1000 to 1100
Moscow		15.320	0530 to 0830; 0915 to 0930; 1030 to 1330; 2200 to 2400

URUGUAY			
Montevideo	CXA6	9.420	1530 to 2100
Montevideo	CXA19	11.830	0600 to 2300
Montevideo	CXA10	11.900	1830 to 2115

VATICAN CITY			
HVJ		5.970	0900 to 0930; 1000 to 1100; 1300 to 1330
HVJ		9.680	1200 to 1330
HVJ		11.740	0015 to 0025; 0830 to 0900; 1100 to 1145
HVJ		15.120	0830 to 0930; 1100 to 1145
HVJ		17.440	0715 to 0915

VENEZUELA			
Barquismeto			
Barquismeto	YV3RS	3.490	1630 to 2130
Barquismeto	YV6RC	3.510	1800 to 2130
Barquismeto	YV3RN	4.990	0630 to 2200
Ciudad Bolivar			
Caracas	YV6RD	6.200	1700 to 2315
Caracas	YV5RY	3.380	0930 to 2230
Caracas	YV5RW	3.400	0530 to 2230
Caracas	YV5RX	3.500	0930 to 1100; 1530 to 2230
Caracas			
Caracas	YV5RM	4.970	0530 to 2230
Caracas	YV5RS	3.530	0530 to 2230
Caracas	YV6R	4.920	0600 to 2230
Cora	YV1RY	4.770	1600 to 2130
Maracaibo	YV1RT	3.370	1730 to 2230
Maracaibo	YV1RU	3.110	1900 to 2130
Maracaibo	YV1RV	4.750	1730 to 2130
Maracaibo	YV1RL	4.810	0530 to 2230
Maracaibo	YV1RK	3.390	1800 to 2230
Merida	YV2RC	3.120	1800 to 2130
Puerto Cabello	YV4RQ	3.180	1700 to 2130
Sao Christobal			
Sao Christobal	YV2RN	4.830	1100 to 2130
Trujillo	YV1RD	3.310	1700 to 2130
Valencia	YV4RP	3.450	1730 to 2130
Valencia	YV4RP	4.780	1630 to 2130
Volera	YV1RZ	4.840	1630 to 2115
YUGOSLAVIA			
Belgrade		6.150	1130 to 1800
Belgrade		9.420	0000 to 0230; 0630 to 0815; 1110 to 1125
Belgrade		9.360	

U. H. F. TUBE SET



EVER since starting radio building, I have been greatly interested in t.r.f. circuits, because their tonal quality is far superior to that of any superhet. The circuit's simplicity makes it easy for even a beginner to assemble, and the small number of parts required keeps the cost well down.

My ambition has always been to build as small and compact a t.r.f. receiver as possible and still keep the circuit's qualities. The result is shown here.

The circuit in itself is straightforward, and as the parts are not too crowded, it is really no trick to assemble

it. By using a 70L7 in the output stage, a full 2 watts is had on a 3-inch speaker—more than enough volume to fill a large room.

The u.h.f. 956 acorn is used as r.f. amplifier and the 9002 as triode detector. By using variable iron-core transformers, the gain per stage is increased.

The 8 x 4 x 4-inch cabinet is painted white; the knobs, the handle, and the speaker cloth are red.

Performance of this set is so good that I practically have to chain it in place for fear visitors will take it away with them.

—Gerard Boulton

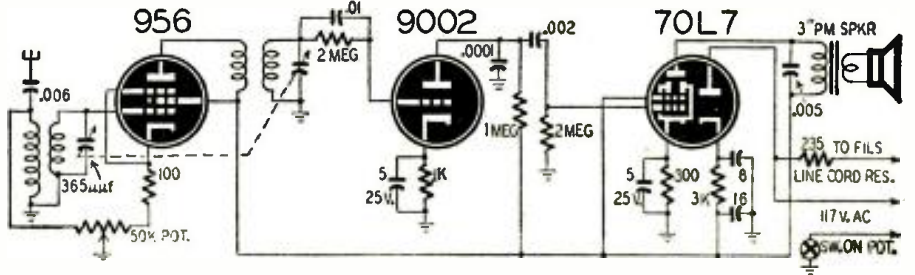

Everybody refers to the

RADIONIC

Catalog!



... BECAUSE IT'S ONE, COMPLETE, COMPREHENSIVE, RELIABLE VOLUME

WE are a well staffed ORGANIZATION equipped to purchase everywhere, any time, all types of radio equipment, and deliver them INTERNATIONALLY and with full technical assistance, consultation and service. Our customers are our "partners" in this growing enterprise which owes its success to RESULTS.

Send TODAY for this FREE RADIONIC CATALOG. Save yourself purchasing time and DOLLARS IN THE BARGAIN. All merchandise is guaranteed, backed by our international reputation for fair dealing.

Chancellor RADIO

- RADIOS • TELEVISION COMPONENTS
- INTERCOMMUNICATORS • RECORDERS
- PUBLIC ADDRESS • TUBES • HARDWARE
- RECORD CHANGERS • TECHNICAL BOOKS
- TEST INSTRUMENTS • PARTS AND ACCESSORIES

RADIONIC EQUIPMENT COMPANY

DEPT. 107 TRIBUNE THEATRE ENTRANCE 170 NASSAU ST., N. Y. 7, N. Y. WORTH 2-0421

MAIL TODAY

RADIONIC EQUIPMENT CO.
Dept. 107, 170 Nassau St., N.Y. 7, N.Y.

Gentlemen:

Please send your Free Catalog No. 47, listing products of leading manufacturers of radio electronic parts and equipment; also, all literature as published.

Name

Street P.O. Box

Town Zone State

NEW BUYS! GREAT BUYS!

kits
for
hams and
experimenters

IMMEDIATE DELIVERY

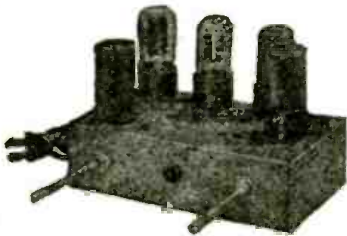

Lafayette 4 Tube Phone Amplifier Kit. Designed for AC-DC operation and has excellent response characteristics. Employs a 35Z5 rectifier, a 12BL7 dual triode as an amplifier phase inverter, and two 36L6 Beam Power output tubes in push-pull. Inverse feed-back provides excellent frequency response. Supplied with a universal output transformer to permit matching of any Permanent Magnet speaker voice coil impedance. Power output of the amplifier is 3 watts. Variable tone control.

This complete kit of parts includes tubes and a punched chassis for mounting ease.
K10457..... **\$10.45**
complete kit



Lafayette All Wave 2 Tube AC-DC Receiver Kit. Operates on 110 volts AC or DC. Employs a 12BJ7 as regenerative detector and 11L7GT combination power amplifier-rectifier. Supplied with 4 coils which cover 10 to 200 meters and take in police, aircraft, amateur, foreign and standard bands. Coils overlap in tuning range. Built-in electrical band spread tuning; output transformer matches receiver output to any PM speaker voice coil. Complete with headphone jack, punched chassis, panel, plug-in coils, tubes, and complete instructions. **\$17.95** complete kit

K10043—set of broadcast coils to cover 100-570 meters..... **\$1.82**
K19269—5" PM speaker..... **\$2.50**

Lafayette Battery Operated All Wave Receiver Kit. Similar to model K10448 above. Employs a 1C5 tube as a detector and a 9Q5 tube as a power amplifier. Battery requirements are a 1½ volt "A" battery, two 45 volt "B" batteries and a 4½ volt "C" battery. Complete kit of parts includes a punched chassis, panel, plug-in coils, tubes, and complete instructions. **\$16.95** complete kit

K19820—kit of batteries..... **\$3.85**
K19269—5" PM speaker..... **\$2.50**

Order Now—Prepaid or C.O.D.

FRANK LESTER, famous W2AMJ, is back again in charge of ham radio at Lafayette. He'll be glad to lend a hand on any ham problem by mail or in person.

Write today for our big, new 144-page catalog—packed from cover to cover with everything you need in radio and electronics. Also ask for flyer C-39 with its latest news on ham innovations and bargains. Both are FREE.

Lafayette Radio

(RADIO WIRE TELEVISION, INC.)

100 Sixth Avenue, New York 13, N. Y. 110 Federal St., Boston 10, Mass. 24 Central Ave., Newark 2, N. J.

TRY THIS ONE

ANTENNA MOUNTING

While looking for an insulator for a 4-section automobile antenna, I found that the base of the antenna was too large to pass through the insulators that I had in stock.

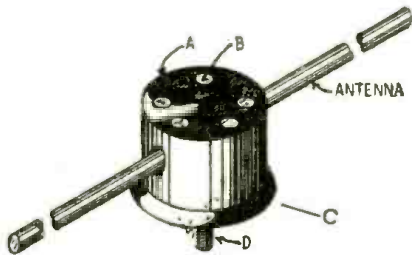

A—bakelite tube base; B—solder in prong holes; C—rubber grommet; D—center screw.

I took the base of a 4-prong tube, cut the prongs as close to the base as possible, and sealed the holes with solder for a smooth finish. I then drilled a ¼-inch hole through the base. The rubber grommets from available insulators fit perfectly over the open end of the base to complete a satisfactory installation.

EMERSON PAYNE,
Quebec, Canada

HANDY "V" TOOL

By putting two V notches (V for versatility) in a small screw driver, as shown, its usefulness to the serviceman can be increased. The notch in the side is used as a hook to pull dial cable through openings and the notch in the end may be used to push cable through holes in the dial assembly.



This end is also used to twist wire in the form of eyelets or loops for connecting wire to screw terminals. It is also very handy when installing resistors and condensers, since the leads can be formed and held in position to facilitate the soldering operation.

JOSEPH S. NAPORA,
Dayton, Ohio

PROTECTING BEAM TUBES

In many transmitters, variable-capacity coupling between the oscillator or driver stage and the control grids of 807's, 813's, and other beam tubes controls the grid excitation. Unless the condenser is widely spaced it may arc or short and place a positive voltage on

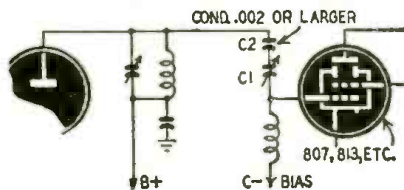

the driven grid. This may ruin the driven tube and burn out r.f. chokes.

To prevent such accidents, connect a 0.002µf, or larger, mica condenser C2

in series with the variable condenser C1. The blocking condenser should have a working voltage of about 2,000 volts for low-power rigs. A small 100µmf trimmer can be used safely for C1.

SAMUEL H. BEVERAGE,
Melrose, Mass.

NOVEL PANEL FINISH

A novel crackle finish for radio panels and cabinets may be made by painting the surface with a slow-drying enamel. When the surface is partially dry, apply a coat of quick-drying enamel. The top coat of enamel will tend to shrink and wrinkle the more pliable bottom coat and produce a realistic wrinkle-finish surface.

RONALD G. BERLYN,
Ballarat, Australia

EXPANDED DIAL

National Type B vernier dials can be altered to provide increased scale length and higher reset accuracy.

The inside rim of the dial housing is cut down about ⅛ inch as indicated by the dotted lines on the drawing. A pointer is cut from thin clear plastic or celluloid and the edges finished with very fine sandpaper or pumice and water. A fine line is scribed down the center of the underside and filled with black India ink. A hole, large enough to clear the condenser shaft, is drilled in the lower end and the pointer glued to the underside of the dial.

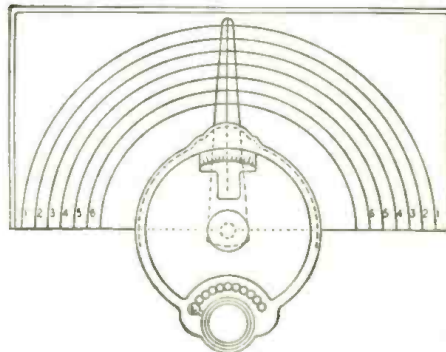

The outer dial scale may be made by drawing concentric semicircles on white Bristol board and covering with a thin sheet of celluloid.

AUGUSTINE MAYER,
Tiffin, Ohio

REMOVING RIVETS

While attempting to drill out some rivets that were used to hold an audio transformer to a chassis, the rivet began to turn with the drill, making further drilling impossible. Other parts located on the chassis prevented the use of a chisel. I flooded solder between the rivet and chassis. This held it tight while the job was completed with a drill.

GEORGE F. CUTRESS,
Welland, Ont.

Nationally
FAMOUS
GIFTS

FREE



MARLIN Rifle
.22 Caliber

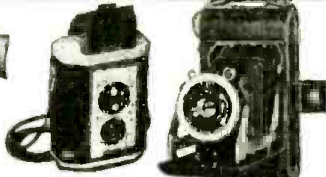

EASTMAN KODAKS



MASTER
METAL Radio
Tool Box

REMINGTON
Electric
Shaver



DELTA
SPOTLIGHT

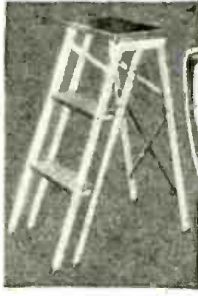

STEP-STOOL
Folding Ladder

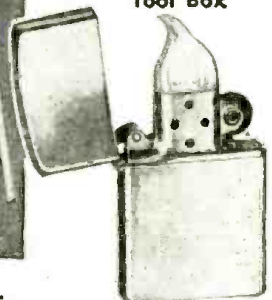

ZIPPO Lighter



HEALTH-O-METER Scale



DORMEYER
Electric Mixer



ELGIN
Compact



RADIO-STEEL
Scooter



PIPES
by
KAYWOODIE

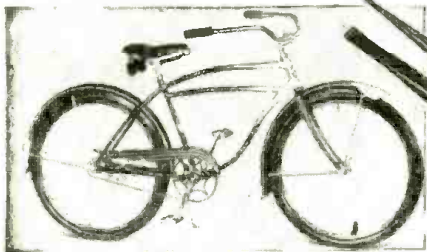

ARNOLD SCHWINN BICYCLE



WESTINGHOUSE
Electric Roaster

**NOBODY BUT OLSON
GIVES YOU A BREAK
LIKE THIS!**

PASTE COUPON
ON POSTCARD

**GET
THIS
BARGAIN
BOOK
NOW!**

Remember, our nationally advertised Radio Parts are priced very low, so you get a better deal in every way at OLSON RADIO WAREHOUSE. Don't wait another minute. Send the coupon for our big new Catalog of Radio Parts and Free Gifts NOW, and start saving those Olson Pointers!

CALLING all radio servicemen and amateurs! You get an honest-to-gosh share in the profits when you buy your Radio Parts from OLSON. We sell the dependable quality Parts you need, and we GIVE AWAY these fine premiums and many others listed in our new Catalog. No strings to these gifts; you don't pay a cent of cash for them. You get them with OLSON POINTERS. Read on!

Olson sends you a free POINTER for every dollar's worth of Parts you order from us. Just pick out the gifts you want and save enough Olson Pointers to get them FREE. No cash, no "box-tops" required. There is NO LIMIT to the number of Free Gifts you can get. Look at the famous brand names on our premium gifts! We selected them carefully so you won't be disappointed. It's all GOOD STUFF!

**RADIO REPAIRMEN'S
PRICE GUIDE**



FREE!

60 pages of new Olson Bargains in Radio Parts, Sound and Testing Equipment. Includes section of FREE GIFTS.

OLSON RADIO WAREHOUSE, Inc.

73 E. MILL ST., DEPT. 87, AKRON, OHIO

I want to save Olson Pointers for premium gifts. Send me your new FREE Premium Book and Price Guide right away.

NAME _____
ADDRESS _____
CITY _____ STATE _____

LATEST TELEVISION COMPONENTS



As Used in the New RCA 10" Receiver

	New Prices
50° Deflection Yoke	\$16.25
Focusing Coil	9.10
Ion Trap for 10BP4	6.50
Vertical Output Transformer	9.00
Horizontal Output Transformer with 9000 V. and 1 V. windings for second anode supply	16.85
Width Control	1.30

Other television parts:

RCA Deflection Yoke for 9" and 12" CR tubes, with special shields for yoke and tube, including brackets	26.75
Rubber Mask and Frame with Shatterproof Glass for 12" CR tubes	8.00
Five band RF Switch and coil assembly	5.60
Cathode Ray Tubes for Television and Oscilloscopes from 1" to 15"	

ALSO

Receiving tubes	Capacitors (Ceramic, oil filled, Mica, etc.)
Sockets for CR tubes with cables	Ceramic trimmers
Coaxial Cable (300, 72 and 50 ohms)	And other television components

Send 50c for complete catalog including diagrams for RCA, GE, DuMont, Stromberg Carlson, Andrea and Viewtone Television Receivers.

World's First Specialized House in Television

TELETRONICS SERVICE AND SUPPLY CORP.
264 West 40th Street New York 18, N. Y.
phone PEnnsylvania 6-8730

OPPORTUNITY AD-LETS

Advertisements in this section cost 20 cents a word for each insertion. Name, address and initials must be included at the above rate. Cash should accompany all classified advertisements unless placed by an accredited advertising agency. No advertisement for less than ten words accepted. Ten percent discount six issues, twenty percent for twelve issues. Objectionable or misleading advertisements not accepted. Advertisements for August, 1947, issue must reach us not later than June 27, 1947.
Radio-Craft • 25 W. B'way • New York 7, N. Y.

PRICES SLASHED—Radio Supplies—Kits—Catalog Free. Technical Laboratory, 341 Wilson Ave., Brooklyn, N. Y.

WRITE DEPT RC 20 FOR OUR LATEST FREE BARGAIN list of Radio and Electronic parts. R.C. Radio Parts and Distrib. Co., 733 Central Ave., Kansas City 6, Kansas.

CORRESPONDENCE COURSES AND SELF-INSTRUCTION books skillfully used. Sold, Rented, Exchanged. All subjects. Satisfaction Guaranteed. Cash paid for used courses. Complete information and 100-page illustrated bargain catalog Free! Write—Nelson Co., Dept. 39, Chicago 5, Ill.

MAGAZINES (BACK DATED)—FOREIGN DOMESTIC. arts, Books, booklets, subscriptions, pin-ups, etc. Catalog 10c (refund). Cicerone's, 803 First Ave., New York 17, N. Y.

FREE WHOLESALE BULLETIN. TUBES, PARTS. Bargain prices. Hengshaw Radio Supply, 3313 Delavan City, Kansas City, Kansas.

AMATEUR RADIO LICENSES, COMPLETE CODE and theory preparation for passing amateur radio examinations. Home study and resident courses. American Radio Institute, 101 West 63rd Street, New York City. See our ad on page 80.

WE REPAIR ALL TYPES OF ELECTRICAL INSTRUMENTS, tube checkers and analyzers. Hazleton Instrument Co. (Electric Meter Laboratory), 149 Liberty Street, New York, N. Y. Telephone—BARclay 7-4239.

BUILD YOUR OWN RADIO KITS OF PARTS \$5.95. Details Rycro Distributors P.O.B. #8, Ozone Park, N. Y.

RADIOMEN, SERVICEMEN, BEGINNERS—MAKE more money, easily, \$250 weekly possible. We show you. Information free. Merit, 210-321, 132nd Avenue, Springfield Gardens 13, New York, New York.

\$3.00 FOR CARTOON IDEAS

RADIO-CRAFT prints several radio cartoons every month. Readers are invited to contribute humorous radio ideas which can be used in cartoon form. It is not necessary that you draw a sketch, unless you wish.

IDEAS NOT WANTED:

No electrical or radio definitions wanted. Some of these were published in the past, but the subject is about exhausted.

Payment is made on publication.

Address

RADIO CARTOONS, RADIO-CRAFT,
25 West Broadway, New York 7, N. Y.

PARASITIC OSCILLATIONS

(Continued from page 37)

and plate leads should be redressed, noting the effect of each change.

It may seem that high-frequency parasitics are difficult to eliminate because the resonating elements are not even known, but they often can be tuned out or damped by using very small trap circuits. Three types of high-frequency parasitic suppressors are shown in Fig. 3, as T1 and T2. A small coil (about 10 turns on a 1/4-inch form) tuned by a mica trimmer (10-100 μmf) often eliminates the undesired oscillation, with little effect on the desired frequency. A resistor of about 10 ohms may be substituted for the condenser as shown in the grid lead. These tuned or untuned circuits are connected in series with plate or grid leads as required. Another effective method is the use of 50-ohm resistors in the screen lead. In this case, the screen by-pass condenser C should be connected at the junction of the suppressor-resistor and the normal screen-dripping resistors.

Many amateurs have difficulty in operating beam power tubes such as the 813 and 4-125A without neutralization, although manufacturer's specifications often state that it can be done. The high-power sensitivity of these tubes makes operation critical under some conditions. Whenever they are operated straight through, the input and output circuits *must* be well isolated. One of the best ways to do this is to mount the

grid-tuning elements below the chassis and the plate elements above it. It is also helpful to submount the socket for these tubes so that the internal shield is level with the chassis.

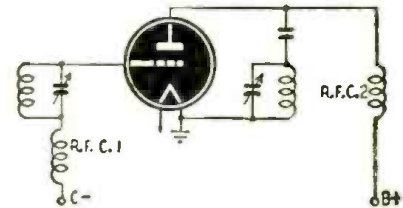

Fig. 2—Low-frequency parasitic oscillator.

When using receiving-type and low-power beam tubes, metal shields should be used between the grid and plate coils and the tubes enclosed in suitable shields.

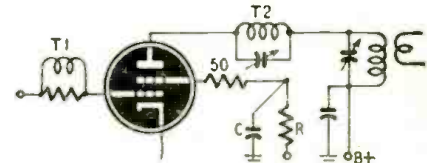

Fig. 3—Three types of parasitic suppressors.

In all transmitting circuits, the grid, plate, filament, and screen grid by-pass condensers should be connected to the socket terminals and returned to a common ground point through the *shortest possible leads*.—I. Queen, W2OUX.

SIGNAL GENERATOR

THIS handy little signal generator covers from 70 to 1500 kc in three ranges, using fundamental frequencies. A large portion of the short-wave bands may be covered by using the harmonics of the broadcast band.

The circuit (Fig. 1) uses a 1G4-G in a series-fed Hartley circuit. Power is supplied by a 22 1/2-volt B-battery and a 1 1/2-volt flashlight cell. Modulated r.f. is available at the output terminal by adjusting a variable grid leak on the front panel. When the resistance is increased, a grid-blocking action is set up, modulating the r.f. at frequencies from 500 to 1,000 cycles, depending upon the resistance in the circuit.

A dial, with 3 unmarked scales, is required. This may be one of several available on the market or may be made

by the experimenter by cementing a celluloid pointer to a knob and using a sheet of white bristol board for the dial.

The 3 coils are "jumble-wound" on a 1/2-inch dowel 4 1/2 inches long, as shown in Fig. 2. L1 covers band A and tunes from 75 to 220 kc. It consists of 1,100 turns of No. 34 wire. L2, 200 to 500 kc. has 450 turns of No. 32 wire. L3 covers the broadcast band (band C) from 500 to 1500 kc. This coil has 175 turns of No. 26 wire. All coils are center tapped. The coils are mounted on the chassis and are provided with a shield that fastens to the chassis. The wire used was double-silk-covered. Single-cotton-covered wire may be used, and enamelled wire two sizes larger will also be satisfactory.

Band switching from the front panel is provided by a 3-position rotary switch. Plate and filament voltages are controlled by a double-pole single-throw switch. A 2,000-ohm potentiometer gives variable control of the r.f. output.

An accurately calibrated broadcast receiver, with tuning indicator, is used to calibrate the oscillator. The receiver and oscillator are allowed to preheat for about 1/2 hour. The r.f. output is adjusted for maximum and a.f. modulation is applied. The output of the signal generator is loosely coupled to the an-

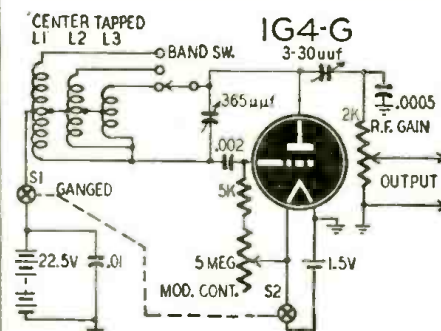

Fig. 1—Portable signal generator circuit.

(Continued on page 80)

A SMALL RECORDING STUDIO
(Continued from page 36)

follow the groove. Too deep a groove can cause distortion as it may place too severe a load on the recording head.

Trying to record at the same level at 33 1/3 r.p.m. as at 78 r.p.m. will cause distortion, particularly near the center of the disc.

An asymmetrical cutting or playback needle will cause serious distortion. The playback pickup cannot track such a groove accurately. A recording needle which is not symmetrical should be re-sharpened. The recording assembly should be checked to ascertain what caused it to wear unevenly.

A recording stylus which is not perpendicular to the plane of the record, that is tilted sidewise, will cause an asymmetrical groove which is impossible for a pickup to track. The playback arm itself must be mounted so that its needle is held perpendicular to the record and the arm bearings do not bind.

5. *Variations in chip.* These variations may be caused by difference in hardness of the blank coating. A dry, hard blank will produce a chip which feels dry and looks dull. The chip should lie straight and be shiny. If it breaks into small pieces, it is an indication of too light a cut, a dull needle, or improper needle angle. The depth of cut has a profound effect on the chip. Experience is the best teacher of the appearance of ideal chip, and measurement with a micrometer is considered good practice.

6. *Intermittent noise.* If you are recording from a radio receiver in the winter or in a dry place, it is essential to ground all the metal parts of the recorder, as a static charge is built up on the disc, which causes a loud crackling sound in the radio. There are several liquid products which when lightly brushed on the disc surface prevent accumulation of a static charge. Of course, loose connections and microphonic tubes also can cause intermittent noises, which under some conditions might be mistaken for those caused by atmospheric electricity.

7. *Wow.* Wow is the result of a variation of speed within one revolution of the turntable. It can be caused by intermittent slippage of the drive system, by glazed rubber drive wheels or worn drive surfaces, uneven loads on the drive motor caused by binding in the lead screw mechanism. If the record does not lie flat, the depth of cut will vary during one revolution, which might vary the turntable speed. Some recorder's depth of cut and cutting angle are dependent upon the thickness of the blank. When different thickness blanks are used, the recorder should be properly adjusted. It is wise to check the turntable and then the lead screw with a spirit level. They should be absolutely parallel.

There are also many more obvious causes of poor recordings, but a generous application of common sense is usually adequate to cope with them.

GOVERNMENT RADIO and ELECTRONIC SURPLUS BARGAINS

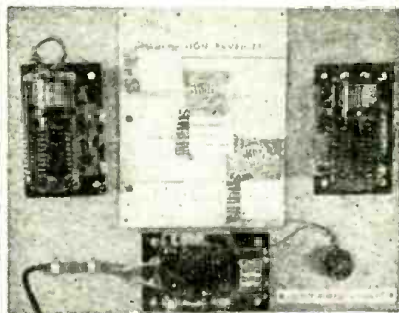

VOLTAGE REGULATOR

KIT 602A-P1
SCR-602-T6-602A

DESCRIPTION AND PURPOSE

Kit consists of three voltage regulators and necessary installation equipment. They are of an improved design and are supplied as replacements for the original regulators in control panels BD-122-T6 and BD-122-A. Two of the regulators function as voltage regulators for the a-c power supply; the third serves to regulate the d-c power supply.

PRINCIPLES OF OPERATION

Regulators are of the carbon-pile rheostat type, whose resistance is varied by changing the pressure on the carbon-pile. A carbon-pile regulator provides this changing force by electrical and mechanical means.

The regulators control the voltage to 80±0.5 volts with full load open circuit. Rheostat turned to extreme left should give 75 volts; turned to extreme right voltage should be 85 volts. If range is high, screw core in; if range is low, screw core out; recheck voltage range with rheostat. After this, turn rheostat to 80 volts. Shock full load on and off and voltage should not rise or drop more than 0.5 volts.

COMPLETE WITH INSTRUCTION BOOKS, EACH **\$4.95**

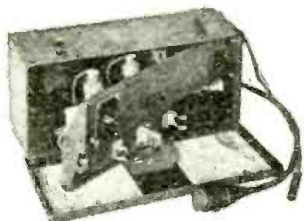

3 Tube AMPLIFIER

using 2-1N5 and 1-1G6. Complete with tubes **\$2.95**



REMOTE CONTROL UNIT

R-29-A NEW..... EACH **\$3.95**



CO-AX CONNECTORS

M359—Right Angle Package of 10... **79c**

We still have a supply of **TG 10 KEYERS**

NEW—EACH **\$15.00**

POWER TRANSFORMERS

1-12 V, 1-12V C.T., 1-5V 700V C.T., 200 Mills. All windings 3A EACH **\$2.00**

MODEL AN-PRS-1

NEW

MINE DETECTORS

EACH **\$9.95**



ANTENNAS

EACH **50c**

All Orders F.O.B. DETROIT, Shipped RAILWAY EXPRESS

RADIO CENTER

2530 EAST DAVISON AVE.
DETROIT 12, MICHIGAN

No order under \$5.00 — Please send check or money order. Orders shipped C.O.D. subject to 20% advance deposit.

"GLOBE" SMASHING SPECIALS for JULY

AMAZING OFFER!!

- 5 tube kit containing: 50L6, 35Z5, 12SA7, 12SK7, 12SQ7 for.....\$2.49
- 5 tube kit containing: 50B5, 35W4, 12AT6, 12BA6, 12BD6 for.....\$2.49

We carry a complete line of popular brand radio tubes AT BELOW WHOLESALE PRICES. Just send us your order for whatever tubes you need. All tubes 100% perfect, new and fully guaranteed, in cartons. Special prices on large orders.

SPECIAL PURPOSE TUBES

"JAN" Inspected Fully Guaranteed

- Acorn Tubes: NOS. 954 to 957.....49c
- Hearing Aid Tubes: NOS. 501AX to 509AX.....49c
- Subminiature Proximity Radio Tubes used in Radar Timing Devices: (D10DE, 6.3 Filament).....69c

POPULAR BRAND CONDENSERS

... First Quality — Fresh Stock

ELECTROLYTICS	BY PASS	
	at 400 Volts	at 600 Volts
20/20 @ 150.....39c	.01	9c
20 @ 150.....25c	.001	9c
10 @ 450.....37c	.003	9c
16 @ 450.....53c	.005	9c
20 @ 450.....59c	.01	9c
10 @ 25.....18c	.02	9c
25 @ 25.....19c	.03	9c
60/30 @ 150.....49c	.06	10c
30 @ 150.....29c	.1	12c
40 @ 150.....33c	.25	17c

Minimum Condenser Order: 10 Condensers

VOLUME CONTROLS

- 500,000 OHMS, S.P.S.T. Switch 2" Shaft47
- 500,000 OHMS, D.P.S.T. Switch 2" Shaft58
- 2-Tube Phono Oscillator—Uses 35W4 and 50B5. Packs terrific wallop4.25
- Kit of 100 Assorted Carbon Resistors. Most Popular Ohmmages. All at 1/2 Watt. Boxed—per box 1001.89
- 5" Alnico No. 5 P.M. Speaker (1 oz. Magnet) 1st Quality1.45
- 5" Alnico No. 5 P.M. Speaker (1 oz. Magnet)1.19
- Output Transformer for 50L669
- 6 Ft. Approved AC Line Cord25
- 25 Ft. Hanks AC-DC Antenna Wire19

BATTERY SPECIAL

Fresh, Standard brand Portable radio battery, 45 Volts "B"\$1.39

THIS MONTH'S SPECIAL
WHILE THEY LAST
70L7 TUBES New and Guaranteed
LIST PRICE \$3.90
Our Price ONLY 79c

- "Globe" prices are lowest wholesale prices anywhere.
- 20% Deposit required with all orders.
- We ship anywhere—prompt service on all orders.
- Money back guarantee on all items.
- Write for our free catalog and order blanks.

GLOBE DISTRIBUTORS
72 Harvard St.
Boston 24, Mass.

Don't forget to refer to the **RADIONIC** Catalog!

Notes on Servicing

By HARRY A. NICKERSON

IN repairing a radio set, first try to learn the symptoms: Does it work at all; faintly? Does it hum badly? Is it intermittent; noisy? Does it whistle? Did the condition come on gradually? Etc. Ask the owner, but be careful not to take his replies too literally.

Test the tubes for emission and shorts or leakage. If possible, test the set in operation with tubes known to be OK.

While a.c. sets may have a bleeder resistance or a speaker field across B- and high B-plus, it is well to test the resistance between B-minus and high B-plus. If it is less than a few megohms, learn the cause before operating the set with a good rectifier tube in the socket. Note that some a.c.-d.c. sets (in compliance with Underwriters' regulations) have a small fixed condenser between B-minus and chassis, so chassis is not B-minus. The cathode of a cathode type rectifier, such as 25Z5, and the filament or tap on filament winding of the 80 type rectifier will be high B-plus.

Be sure that all tubes are in the correct sockets. The 12SA7, 12SK7, 50L6, and 35Z5 have filaments at 2 and 7 prongs; but 12SQ7 has filaments 7 and 8. In small portables it may be worth while to check the resistance of each tube at the socket terminals, remembering that some may be 0.05-ampere filaments with a shunt resistor to operate with 0.15-ampere tubes in series. Resistance of a hot filament varies considerably from that of cold filament.

Of course the most used formula in radio repair is Ohm's law. Put this in a circle, as shown on this page. Cover over any letter and you have the value of that letter. Thus, cover I and you

have $\frac{E}{R}$.



Line cords and ballasts

A resistance line cord may be used to replace a ballast tube, and vice versa, as a general rule. If the resistance is not known, divide the voltage drop by the current in amperes passing through the string of tubes. Suppose we have 25L6, 25Z6, 6K7, 6J7 in series. The tube voltages will be 25, 25, 6.3, and 6.3, total 62.6 volts, which subtracted from line voltage of 117 leaves voltage drop of 54.4 volts. Dividing 54 by 0.3 (amp) filament current the resistance wanted will be 180 ohms.

Pilot light calculations

If we wish to insert a pilot light in such a set, we connect it in parallel with a portion of the 180-ohm resistance, or in practice, use a lower-resistance line cord, such as 160 ohms, and insert a 20-ohm resistor in the circuit, for a 6-8

volt lamp, 0.25 ampere filament. Again using Ohm's law, we find the value of the resistor by dividing the voltage of the dial light, 6, by 0.25, with the answer 24 ohms. The higher value we make the resistor, the brighter will burn the light, because with the two in shunt, more current will pass through the lamp when the resistance of the resistor is increased. (See Fig. 1.)

Calculating resistor wattage

The resistor in the above example must be able to carry the current that passes through it without overheating. So we calculate the required wattage, still using Ohm's law:

$$W = \frac{E^2}{R} \text{ or } \frac{6v^2}{20\omega} = \text{or watts} = \text{---}; \text{ or about 2 watts.}$$

In practice the wattage is figured at 2 or more times the calculated value, so we would use a 5-watt resistor.

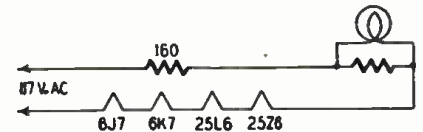

Fig. 1—The pilot lamp and its resistor.

Set manufacturers got together and decided on a color code for wires, resistors, condensers, etc. In most modern sets, you can look at a wire and say, "this is high B-plus," "this is filament," etc.

Filament is yellow; B-plus, red; grid, green; black, negative; plate, blue. On power transformers, the primary is black, and high-voltage secondary is red. The primary will have a low resistance of say 5 ohms, while the high-voltage secondary may have total of as much as 200 ohms resistance. Other low-voltage secondary windings will have very low resistance. Secondary winding carrying the most amperage will be heavier wire.

Modern color codes

If you have not memorized the color code, you can perhaps use this help: Starting with zero, the initials of the colors are BBROY for the first five: black 0, brown 1, red 2, orange 3, yellow 4. A 1-megohm (1,000,000-ohm) resistor has green as the "third significant figure." Thus, the central spot or third circular line figured will be green. Also, beginning with red, you will notice that the colors red, orange, yellow, green, blue, violet are those in the so-called color spectrum.

While many service men are still getting along with a volt ohmmeter, a pair of pliers, soldering iron, and screw driver, particularly the latter, together with a lot of experience, it is probably impossible to repair all sets without considerable equipment, which includes a complete set of service manuals or

(Continued on page 67)

COLOR TELEVISION

(Continued from page 25)

nel width of 32.5 mc, which is impractical under present frequency allocations and limitations of receiver design.

Network transmission of sequential color images were successfully carried out by CBS engineers. One test was made over the A. T. & T. Co. co-axial cable loop between New York City and Washington, D. C., and return (total length 453 miles). Tests were made at 40 and finally 48 color frames per second. The video frequency cutoff in this instance was 2.9 mc. A check by one of the visiting engineers who saw the demonstration revealed that there was a considerable loss in resolution due to the cutoff at 2.9 mc, which was to be expected.

A later test was conducted with the sequential system over the microwave radio link operated by the Bell Telephone Laboratories between New York City and Murray Hill, N. J.

The simultaneous color system developed and demonstrated by RCA has the advantage that all three basic colors are continuously transmitted. Some experts claim that this is very essential, when it comes to the pickup and transmission of fast-moving objects such as a football, tennis ball, etc., during the course of a game. Color breakup is liable to occur in such cases, with the result that an object moving across the screen rapidly may be seen in several different colors, owing to the fact that the necessary color is not transmitted at certain critical instants with the sequential system.

The first theater-size color television

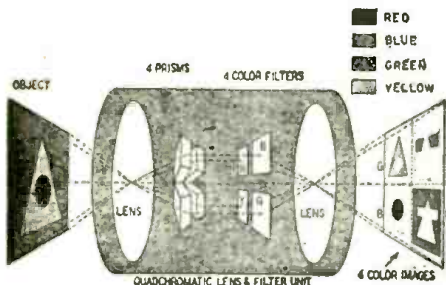

Fig. 4—The Sleeper color analyzer unit.

was recently demonstrated by RCA in Philadelphia, using the simultaneous system. The image was 7½ by 10 feet. The number of lines used was 525. Many who witnessed the demonstration said that the color television images compared favorably with regular technicolor movies. As 525 lines compares with 16-mm home movies, about 1,000 lines are ordinarily required to give the same resolution as 35-mm movies. As explained previously, the addition of color gives an apparent definition considerably above the 525 lines used.

With the simultaneous system of color transmission black-and-white receivers can pick up monochrome images by the simple addition of a converter. (Present B & W receivers cannot pick up the high frequencies allotted to color television.) This is not possible with mechanical

The KXP-30 Phonograph or Monitoring Amplifier

for Broadcast Station, Recording Studio, Wired Music Reproduction and for Deluxe Home Phonographs

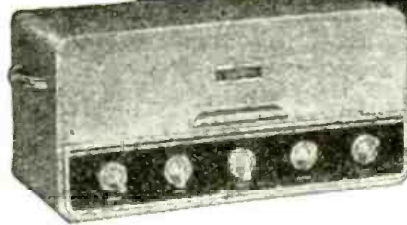

A phonograph amplifier with remarkable performance and flexibility of application . . . the KXP-30 offers full retention of both bass and treble tones at even the lowest volume levels, a quality not found in ordinary amplifiers. . . . Wiring in one input channel provides for use of a plug-in input or bridging transformer, to convert to a 5000-ohm balanced line bridging or 50, 200 or 500 ohms balanced line input as desired. The other channel is equalized for use with a crystal pickup. The KXP-30 features extremely low distortion at all frequencies and volume levels; freedom from hum; uniform power output; dual acting individual tone controls; extended flat frequency response from 20 to 20,000 cycles.

SPECIFICATIONS

POWER OUTPUT: 30 watts at less than 5% distortion with wide flat power output versus frequency curve and low distortion at any volume level. FREQUENCY RESPONSE: 20 to 20,000 cycles within 1 d.b. INPUTS: (2) One with crystal pickup network, impedance ½ meg-ohm. Other without phono equalizer but wired for use with TR-91 or TR-92 plug-in input transformer, impedance without transformer ½ meg, with transformer, 50, 200 or 500 ohms, depending on transformer used. OUTPUT IMPEDANCES: (6) 3, 4, 6, 8, 16 and 500 ohms to terminal strip and two bakelite molded sockets. GAIN: 85 d.b. either input, high impedance. 79.5 d.b. with TR-92. 73.5 d.b. with TR-91. TONE COMPENSATION: Bass range from -17 to +24 d.b. Treble range from -24 to +24 d.b. CONTROLS: (5) Two channel input, one bass, one treble, one power switch. CONTROL PANEL: Etched metal, fully illuminated. POWER CONSUMPTION: 144 watts. TUBES: (7) One 617, three 6J5, two 6L6G, one 5U4G. DIMENSIONS: 7" x 8½" x 15". SHIPPING WEIGHT: 26 lbs.

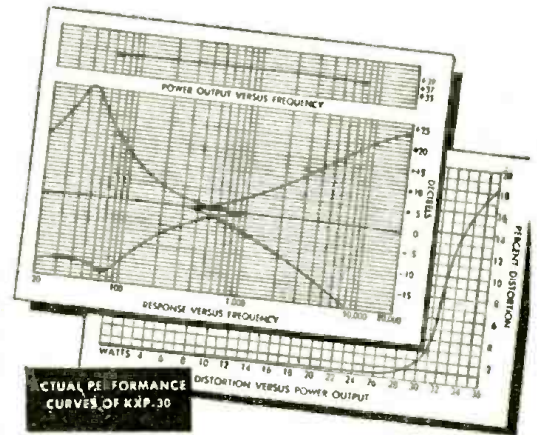

ACTUAL PERFORMANCE CURVES OF KXP-30

Another contribution by Newcomb toward better record enjoyment, Model LP-1 Filter and Equalizer greatly reduces surface noise and distortion. Designed for installation in either commercial or home phonographs the LP-1 is easily connected between crystal pickup and amplifier, providing an effective control of needle scratch.



A phonograph system built around the KXP-30 and the LP-1 offers a remarkable quality of reproduction. You have not heard the best until you hear Newcomb.



"NOT MERELY AS GOOD AS THE OTHERS . . . BUT BETTER THAN ALL OTHERS."

sequential systems. Another feature is that electronic color television receivers can pick up black-and-white programs. A broadcaster with the RCA electronic system can operate a B&W and also a color transmitter, using the signals from the color camera to operate both transmitters.

Other features of the electronic simultaneous system are: freedom from flicker; greater picture brightness; no color breakup; less band width than that required for the sequential system; greater flexibility for network operation; compatibility with present commercial television, to the extent of interchangeability and consequent avoidance of obsolescence of one by the other.

Get Started in Radio



10 "HOW-TO-DO-IT" BOOKS

Get a solid foundation in radio by means of these 10 timely text books. Each clearly written, profusely illustrated, contains over 15,000 words. You'll be amazed at the wealth of information packed into these handy books. Excellent for reference—ideal for technical library. Your money back if not satisfied.

5 BOOKS for 50c
10 BOOKS for \$1.00

Sent to You Postpaid

- | | |
|--|-------------------------------------|
| No. 1—How To Make Four Doodle Short Wave Sets | No. 6—How To Have Fun With Radio |
| No. 2—How To Make The Most Popular All-Wave 1 and 2 Tube Receivers | No. 7—How To Read Radio Diagrams |
| No. 3—Alternating Current for Beginners | No. 8—Radio for Beginners |
| No. 4—All About Aerials | No. 9—Simple Electrical Experiments |
| No. 5—Beginners' Radio Dictionary | No. 10—Television |
- Remit by check or money order—postmaster letter if you send cash or stamps.

RADIO PUBLICATIONS

25A West B'way.

New York (7)

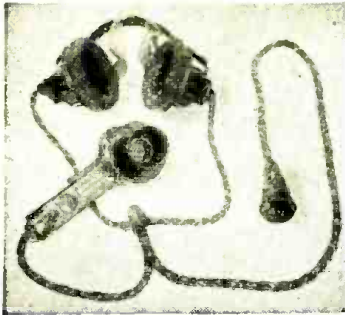

ARMY RADIO PHONES

They're Weather—Water and Shock Proof

When we say they are made to Army specifications, that's enough assurance they must be of best quality. These Army Radio Phones are perfect and were O.K.'d by Signal Corps Inspectors. These Dynamic Mikes and Receivers, were used on aircraft and tank inter-communication systems. Use them for recording, for batteryless phone, for pocket size set loud speaker or talk through your radio set. We bought a good many of these Radio Phones, they are brand new, and cost a great deal more than you can get them for. A complete dynamic hand mike. 2 earphones, headband, cord set.

\$3.45

GENERAL RADIO 433A Potentiometers 100,000 ohms, wire wound 6" diameter **\$1.95**

BC 406 RECEIVER 15 tubes, tunes 195-207Mc, 110 volt, 60 cycle. Suitable for conversion to 2 meters or Television. Special 15.95	BC 645 TRANS RE-CEIVER 420-450Mc; 460-490Mc; complete with tubes and W.E. 316A doorknob and conversion diagram. Brand New 14.95
--	---

OIL FILLED CONDENSERS	ALL STANDARD BRANDS
10 MFD 600v DC .98	0.1 MFD 7500v DC 1.50
2 MFD 1090v DC .79	0.02 MFD 8000v DC .98
10 MFD 1500v DC 3.50	2 MFD 10000v DC 17.50
2 MFD 2000v DC 1.75	16 MFD 300v DC .98
4 MFD 3000v DC 5.95	7 MFD 330v AC 1.25

HEINEMANN CIRCUIT BREAKERS—Magnetic type in 5-20-35-65 amp sizes. Special **.95**

BULL'S-EYE Pilot assembly; 110v AC Candelabra base; 1 inch Jewel U-L approved **.50**

BUSSMAN FUSES type 8AG; 1/100 amp; suitable for meter protection. Per doz. **.50**

SELSYNS—type 5 syncro transmitter, used in pairs as transmitter and follower. 110v AC. Per pair \$5.00	SELSYNS—Indicator type in armored case; No 11-1 110v AC. Per pair \$9.00
--	--

METER BUYS

0-1 MA 2" McClintock 2.45	0-1 MA 3" General Electric 3.50
0-1 amp R.F. 2" General Electric 2.45	0-30v AC 3" Westinghouse 2.45
500-0-500 Microamps 4" Western Elec. 3.75	

NEONS—While they last	CONTROL BOX for 522 Transceiver—consists of 5 push button switches, 5 W.E. Co pilot lite assemblies and lever switch, all mounted in box. Brand New 1.25
2 W Edison base .29	
1/4 W Screw and Bay base20	
1/25 W Bay base and wire leads .08	

SCHWEIN—Free and Rate Gyro. Operates from 24 volts DC; complete in metal case ready for use. Special **5.00**

TWIN LEAD 300 ohm cable, 100 ft. **2.95**
COAXIAL CABLE 52 ohm RG/80 100 ft. **4.25**

If not rated 25% with order, balance C.O.D. All prices F.O.B. our warehouse New York.

No order under \$2.00

We ship to any part of the globe

LEEDS RADIO CO.

75 VESEY ST., Dept. RCJU

COrtland 7-2612 New York City 7

AN ELECTRONIC PHOTOMETER

(Continued from page 27)

the negative potential generated by the phototube. The instrument is adjusted for an arbitrary balance at zero illumination after the preliminary warming up. It is then ready to read directly on the voltmeter circuit accurate relative values of light falling on the phototube. Referring to Fig. 4, the operation of the instrument is:

Light falling on the phototube surface releases electrons which in passing through the high resistance R1 generate a high negative potential on the grid of V1, upsetting the balance of the circuit and causing the indicating meter to drop to zero. If now a bucking positive potential is applied to resistor R1 from potentiometer R2 the circuit balance will be restored when this potential equals that generated by the electron flow from the phototube.

Cathode coupling is employed between V1 and V2, as the current flow through V1 is so small—measured only in microamperes—that few experimenters have an instrument sensitive enough to detect the flow with any degree of accuracy. This small current, however, can generate an appreciable voltage across cathode resistor R3. This voltage is communicated to the grid of V2. The latter tube, being of reasonably high mutual conductance, and operating with reasonable impedance in its grid circuit, is capable of passing a plate current well within the capability of a low-range milliammeter. The author employed a meter with a full scale of 1.5 ma. It gave a convenient balancing point at the 1-ma mark, and provided a sensitive voltmeter when operated with suitable series resistors.

The tubes used were Australian types, but the meter is uncritical as to tubes, and any medium- μ triode may be used. It would be convenient to use a double-triode type (one of those with separate cathodes).

The mechanical construction may take any form suited to the components available. Mount the phototube in a shielded head. If suitable light-gauge metal tubing is not available, a coating of tinfoil pasted inside a bakelite tube will provide combined electrostatic and mechanical shielding for the tube. Provide a small cover for the phototube window so that it may be balanced under dark conditions against any leakage or thermal currents which form a threshold conductance.

To eliminate series resistance and the use of tubes with high-voltage heaters,

the heaters should be operated from a small transformer with an output voltage of 6.3 volts. The approximate 150 volts positive and negative may be obtained from any full-wave twin-heater rectifier as used in voltage-doubling circuits, or two old receiver tubes may be operated—as in the author's equipment—to give the same result. Always operate V1 with as low a heater power as possible, preferably about 4 volts. It functions with a very high grid resistance, and any appreciable heating of the grid may produce sufficient emission to make the circuit unstable. As the function of this tube is to pass only a few microamperes of current, this low voltage will be found ample.

Having connected the circuit as indicated, cut off all light falling on the phototube, and adjust the balancing resistor R4, keeping R2 at zero position, until V1 and R3 balance to produce just enough negative potential on the grid of V2 to allow V2 to pass 1 milliampere (or any value suitable for a balance of the circuit). Note this current, and preferably mark it on the instrument scale for all future resettings. Now if light is allowed to fall on the phototube the negative potential produced on the grid of V1 will reduce the voltage across R3

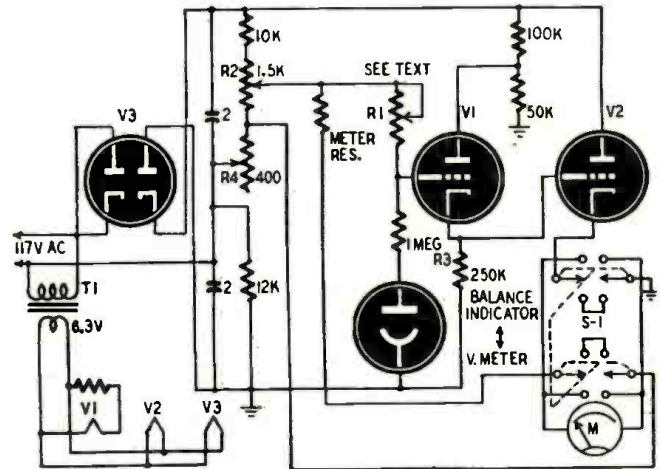

Fig. 4—This 4-tube meter is more reliable than the optical type.

and apply a negative voltage to the grid of V2, dropping its plate current to zero. Adjustment of R2 now will produce an opposing voltage on R1 which will restore circuit balance as indicated by the meter in the cathode of V2 returning to its balanced condition. Now throw the change-over switch and read the value of the voltage tapped off from potentiometer R2.

Once having calibrated the phototube photometer against a photograph exposure meter at some convenient illumination level it now will be possible to read proportionately the light value falling on the enlarger easel.

Selection of the phototube is of importance. For photographic purposes a phototube sensitive to blue light should be employed. The author's phototube is

a type 929, which in addition to having a good blue sensitivity has a light sensitivity well above that of the 926, 922, or wide-band and red-sensitive tubes. This tube has a sensitivity of approximately 45 microamperes per lumen, which with its light window area of 0.6 square inch or 1/240 square foot corresponds to 45/240 microampere per candlepower or approximately 0.2 microampere. From this it is possible to estimate with a considerable degree of accuracy the voltage which can be generated on the grid of V1 if the load resistance is known. With a value of 20 megohms of well-insulated resistors, the theoretical voltage generated at the grid of V1 will be 4 volts per candlepower, and as it is possible to read the voltmeter accurately to as low as 0.1 volt, light as low as 1/50 candlepower may be read with ease. By fitting a small rotary resistor with taps to the low impedance end of R1, it is possible to vary the sensitivity of the instrument for reading of high-candlepower light. If the positive balancing potential from R2 is limited to 10 volts, range 1 with 20 megohms will cover 0.02 to 1 candlepower. Range 2 with a load resistance of 2 megohms covers 0.2 to 10 candlepower and range 3 with R1 reduced to 200,000 ohms covers from 2 to 100 candlepower.

The mechanical layout may well be left to individual tastes. The author has found that a very convenient arrangement is to mount the indicating meter potentiometer resistor R2 and zero-setting resistor R4 plus change-over switch S-1 in a small box to be mounted near the enlarging easel. This leaves the location of the rectifiers and indicating tubes merely a matter for personal convenience. Connect the meter panel to the rectifier and tube section by a flexible cable. Screening is not necessary for this cable, as high-impedance circuits do not pass through it. The cable to the phototube, however, should be well screened, as this portion is very sensitive to electrostatic fields, the consequences of which are highly noticeable when attempting to operate with an un-screened cable.

Mount the phototube with a small handle similar to the construction described for the elementary oil-spot instrument. It then can be moved across the field of the enlarger easel for rapid analysis of the projected image.

This instrument may be used for other than photographic purposes. If a relay is connected in the plate circuit of V2 it is possible to make an equipment for switching on lights at predetermined light levels. The application will be evident to experimentally-minded photographers.

CODE OSCILLATOR

(Continued from page 42)

high side of the volume control and connected to another tip jack. When the key is plugged into the jacks and depressed, part of the audio voltage is fed back through the volume control, caus-

It's Easy and Thrifty to Buy on NEWARK'S New...

TIME PAYMENT PLAN

Choose What You Need NOW—TAKE ONE YEAR TO PAY!
20% DOWN—12 MONTHLY PAYMENTS!

Yes, Your Credit is Good at NEWARK! Now you can buy all the wonderful new equipment you want—Receivers... Transmitters... Test Equipment... Sound Systems... Parts... and hundreds of other items... for only a Small Down Payment! Yes, take ONE YEAR TO PAY the Balance on our convenient Low Cost Plan. The only carrying charge, is 6% of the unpaid balance. No More!

It's so simple! So easy! Here's how the plan works: Choose any equipment totalling \$75 or more from our tremendous stock of standard lines... Pay only 20% down... The balance in 12 Easy Monthly Installments. For example: If you choose a \$125.00 item, pay only \$25

LIBERAL TRADE-IN ALLOWANCE—You'll like Newark's Fair-Deal Policy—A liberal trade-in allowance on your present equipment toward the purchase of any new unit. Write us—or drop in at any of our convenient stores in New York or Chicago to discuss the details.

down, leaving a balance of \$100, plus only \$6.00 carrying charge. Then pay \$8.84 per month for 12 months. That's all!

Don't wait! Enjoy that new rig! USE IT NOW... PAY LATER! Get those Parts or Test Equipment, or whatever you need NOW... and Pay while you use it! Take advantage of NEWARK'S Convenient Time Payment Plan TODAY!

We are AUTHORIZED DISTRIBUTORS of ALL STANDARD MAKES of RADIO and ELECTRONIC EQUIPMENT. Look at the partial list (Below) of New Equipment NOW IN STOCK—All available Now on Convenient Time Payments:

RECEIVERS • TRANSMITTERS • P. A. EQUIPMENT • TEST EQUIPMENT • RADIO, ELECTRONIC & TELEVISION COMPONENTS

SOME OF HUNDREDS OF ITEMS AVAILABLE ON TIME PAYMENTS

RECEIVERS			
Description	Price	Down	Per Mo.
NC-173T, With Speaker	\$189.50	\$37.94	\$13.39
NC2-40-DT, With Speaker	241.44	48.36	17.06
NC-46, With Speaker	107.40	21.48	7.59
HRO-5TA1, w/Pow. Supply	697.294.71	59.03	20.82
HALLICRAFTERS			
S-40A, Receiver	89.50	17.98	6.32
SX-42, With R42 Speaker	304.50	60.90	21.52
SP-44, Panorama Adapter	99.50	19.94	7.03
HAMMARLUND			
SPC-400X, w/Speaker in Cab.	347.25	69.45	24.54
HQ-129X, w/Speaker in Cab.	173.25	34.65	12.24
R. M. E.			
UHF-152, Hl. Freq. Conv.	86.60	17.36	6.11
RME-84, Complete	98.70	19.74	6.97
RME-45, Complete	198.70	39.70	14.04
COLLINS			
75A-1, Receiver	530.00	106.04	37.44
TRANSMITTERS			
COLLINS			
30KI, Transmitter	1825.00	365.08	128.96
32VI, Transmitter	590.00	118.04	41.69
HALLICRAFTERS			
HTS, 100 Watt Transmitter	289.50	57.54	20.49
TEMPCO			
75GA, 75 Watt Transmitter	495.00	99.00	34.98
500GA, 500 Watt Transmitter	1500.00	300.00	106.00
SUPREME			
AF-100, 100 W. Xmtr. Comp.	450.00	90.00	31.80
T60-1, 60 Watt Transmitter	150.00	30.00	10.60
SONAR			
VFX-680, All Band Exciter	87.45	17.49	6.17

TEST-EQUIPMENT			
Description	Price	Down	Per Mo.
155-C, 3" Oscillograph	115.00	23.08	8.11
160-B, 5" Oscillograph	185.00	37.04	13.07
162-C, Channalyt	162.50	32.54	11.48
WV-75A, Volt Ohmyst	125.00	25.04	8.83
WAS4A, Audio Oscillator	152.50	30.58	10.77
SUPREME			
546A, 3" Oscilloscope	87.95	17.63	6.21
561, Oscillator	133.87	26.83	9.94
HICKOK			
191X, Microvolt Generator	145.92	29.28	10.30
305, Oscillograph & Oscil.	145.50	29.10	10.28
288X, Signal Generator	159.06	31.86	11.23
534, Tube & Set Tester	138.30	27.66	9.77
JACKSON			
652, Audio Oscillator	117.00	23.40	8.27
WESTON			
796, Tube Check & Analyzer	187.09	37.45	13.22
785, Circuit Tester	103.59	20.79	7.32
TRIPLETT			
2432, Signal Generator	86.73	17.37	6.13
1632, Signal Generator	107.80	21.64	7.61
PRECISION			
954P, Port. Tube & Sat Tester	97.22	19.46	6.87
DUMONT			
164E, 3" Oscillograph	105.00	21.00	7.42
208B, 5" Oscillograph	235.00	47.08	16.60
274, 5" Oscillograph	115.50	23.10	8.16
SIMPSON			
330, Tube Tester	96.53	19.37	6.81
415, Signal Generator	112.70	22.58	7.98

\$5 Deposit with Your Order Now Will Reserve Your Equipment

Prices subject to change
Shipments F.O.B., New York or Chicago

NEW YORK
Offices & Warehouse
242 W. 55th St., N.Y. 19

NEWARK
ELECTRIC COMPANY, INC.

CHICAGO
323 W. Madison St.
Chicago 6, Ill.

New York City Stores: 115-17 W. 45th St. & 212 Fulton St.

ing a "howl." This howl or audio note can be varied in pitch by adjusting the volume control which, in this case, acts as a tone control. This makes an efficient and handy code practice oscillator.

RALPH BLOOM,
Brooklyn, N. Y.

STEREOPHONIC SOUND

A high-fidelity stereophonic sound system developed in Germany during the war creates the illusion of natural auditory depth, a recent Department of Commerce report states. The system uses three communication channels for reproducing sound as well as for recording it. The recorder handles a frequency range of 23 to 10,000 cycles and a dynamic range of 60 decibels with a

AMAZING NEW FM-TELEVISION ANTENNA

New sensational 300-ohm folded dipole antenna. Affords many advantages over present antennas. No more elaborate high priced installations required. Easily installed on roof, under rug, or behind furniture.

Packed complete with instructions. \$89 each
Shipped prepaid... Specify television or F.M. (new or old freq.). Fully guaranteed and immediate delivery.

CALLING ALL HAMS PHASE MODULATED KIT

The F.M. 1001 is basically a phase modulated exciter affording simulated frequency modulation. No more expensive modulators required.

Your present C.W. Transmitter from 1 Watt to 1 K.W. input can be used without any loss to the input. The F.M. 1001 is constructed on a heavy black cracked chassis measuring 5x10x3 and is supplied in Kit form complete with two coils, instructions and schematic. \$19.95 each

Send Check or Money Order. No C.O.D.
Mfg. by EASTERN ELECTRONICS CO.

147 Chambers Street New York 7, N. Y.

harmonic distortion of less than 3 percent. Film noise is 70 decibels below the greatest amplitude.

Just off the Press



No. 34 — RADIO-ELECTRONIC CIRCUITS: A collection of circuit diagrams, with brief, to-the-point descriptions of each, to inspire the radio man bent on developing new circuits. Among the many practical, tested circuits are: Inter-communication Systems—Power Supplies — V. T. Voltmeters—Receivers—Phono Amplifiers — Short Wave Adaptors — Electronic Relays. Main feature of this unusual and valuable book is the large number of clearly illustrated circuits.

**ONLY
50c
each**

All 10 Books NOW READY RADIO-CRAFT NEW LIBRARY SERIES

This handsome modern series of popular technical books has made a hit overnight. Many of the volumes are already in their second printing. The reason is evident. They supply an urgent demand for reliable radio information that can be grasped and put to use in double-quick time. Large type, carefully printed, well illustrated.

- #29 — **HANDY KINKS AND SHORT CUTS.** Kinks on antennas, servicing, the shop, power supplies, etc. — arranged by sections for easy reference.
- #30 — **UNUSUAL PATENTED CIRCUITS 1944-46.** A digest of new radio-electronic circuits, many the result of wartime research, valuable to anyone in the electronics field.
- #31 — **RADIO QUESTIONS AND ANSWERS.** Answers to questions most frequently asked the "Question Box" editor of RADIO-CRAFT.
- #32 — **ADVANCED SERVICE TECHNIQUE.** An up-to-date collection of specialized information on servicing appealing to the advanced serviceman.
- #33 — **AMPLIFIER BUILDER'S GUIDE.** For the designer and constructor of sound equipment. A wide range of technical data on amplifier design and constructional details of many amplifiers.
- #34 — **RADIO-ELECTRONIC CIRCUITS.** (See description to left.)
- #35 — **AMATEUR RADIO BUILDER'S GUIDE.** Practical and down-to-earth construction data on amateur receivers, transmitters, and accessory equipment.
- #36 — **RADIO TEST INSTRUMENTS.** How to build signal tracers, capacity meters, portable and bench multimeters, signal generators, tube checkers, electronic voltmeters, etc.
- #37 — **ELEMENTARY RADIO SERVICING.** Covers: Planning and Equipping the Shop, Systematic Circuit Checks, Signal Tracing Methods, Servicing Midget Receivers, etc.
- #38 — **HOW TO BUILD RADIO RECEIVERS.** 18 modern sets are described including shortwave, broadcast, v.h.f., portable, a.c. operated, a.c. d.c., and miniature types.

DYNAMIC PICKUP (Continued from page 30)

arm (measured from needle point to pivot) gives an error of two degrees maximum with two perfect points of tracking.

The pickup is now ready for use, but a coupling transformer is necessary as the impedance of the coil is not more than a few ohms. A microphone transformer of a ratio of 50-1 to 150-1 is excellent for this purpose. For preliminary testing, an ordinary output transformer will do very well, but for best results in service, a transformer designed for this type of work should be used. Watch for hum with a high-ratio transformer. Shielding may be needed.

The grid of the first tube should be fed through a condenser of 0.01 μ f.

Compensation circuits

One further point should be mentioned. This pickup is truthful. Records are not. They have a bass cut and often a treble boost, running each way from a crossover point, usually in the octave above middle C on the piano. This method of recording is necessary for technical reasons which need not be discussed now. But it follows that a tone correction, or equalization, network is necessary. The circuit published in RADIO-CRAFT, November, 1945, in an article by George Bertsche is excellent. Using full, or nearly full, bass boost and 60 to 75 percent top cut, the results are as near to perfection as may be found.

In conclusion, here are a few practical notes. Do not use too strong a magnet, or its attraction to the turntable will increase the apparent weight of the pickup. If this effect is troublesome, pad the turntable top with composition board or, better if you can get it, 1/4-inch sponge rubber. Best practice is to mount the pickup floating on sponge rubber.

Finally, this type of pickup is not critical, and the design given may be adapted or changed in any way desired. The only essential thing is a light coil of few turns vibrating across a magnetic field. A pickup using this principle, but using rubber damping (which in this writer's view is undesirable) can be made by cutting a celluloid form barrel-shaped from an old toothbrush handle, making it 3/8-inch long, 1/2-inch in the middle, and 1/16-inch at the ends. A groove can be nicked around its length, 20 turns of wire set in, and the needle jammed in a tapered hole in the middle. The coil is mounted by slipping small pieces of rubber tube over the ends and clipping these in the pole pieces. Results are good, too, and what could be simpler? The device outlined, however, while taking more time and care to work out, will be more durable and give trouble-free reproduction indefinitely.

Those who are addicted to that horrible sound known as "a lovely mellow tone" will not be interested in this pickup. But any who want accuracy and brilliance; who seek the nearest thing to perfect reproduction may find it worth constructing.

RADIO-CRAFT PUBLICATIONS, Dept. 77
25 West Broadway, New York 7, N. Y.

See Your Dealer
If He Can't Supply You, Use Coupon

Send me the volumes (50c each, postpaid) checked. My dealer is unable to supply.

All 10 Books

I enclose \$.....

29

34

Your Name

30

35

Address (Print Clearly)

31

36

Dealer's Name

32

37

Address

33

38

MORE SERVICE - - - LESS MONEY!!

THE MODEL 450 TUBE TESTER



A complete up-to-date unit designed for both bench and portable work. Uses a 4½" square rugged meter. Features an unusually attractive etched panel and comes housed in a beautiful hand-rubbed oak cabinet. Portable snap-on cover makes it ideal for either bench or portable use. Up-to-date, of course, it checks the many post-war miniature tubes such as the 6AG5, 6AQ6, 12AT6, 12BD6, 26D6, 35W4, 50B5, 117Z3, etc., in addition to all other receiving tubes.

Specifications:

- ★ Tests by the well-established emission method for tube quality, directly read on the scale of the meter.
- ★ Tests shorts and leakages up to 3 Megohms in all tubes.
- ★ Tests leakages and shorts of any one element AGAINST all elements in all tubes.
- ★ Tests individual sections such as diodes, triodes, pentodes, etc., in multi-purpose tubes.
- ★ Tests BOTH plates in rectifiers.
- ★ New type fine voltage adjuster.
- ★ NOISE TEST: Tip jacks on front panel for plugging in either phones or external amplifier will detect microphonic tubes or noise due to faulty elements and loose internal connections.
- ★ Works on 90 to 125 Volts 60 Cycles A.C.

Model 450 comes complete with portable cover and all operating instructions.

ONLY
\$ 39.⁵⁰

PLEASE PLACE YOUR ORDER WITH YOUR REGULAR RADIO PARTS JOBBER. IF YOUR LOCAL JOBBER CANNOT SUPPLY YOU, KINDLY WRITE FOR A LIST OF JOBBERS IN YOUR STATE WHO DO DISTRIBUTE OUR INSTRUMENTS OR SEND YOUR ORDER DIRECTLY TO US.

SUPERIOR INSTRUMENTS CO., 227 Fulton St., Dept. RC-7, New York 7, N. Y.

to tune this set. The capacity is varied by pressing one metal plate against another, a thin sheet of insulation separating the two. The closer the plates, the higher the capacity and vice versa.

The receiver is housed in an attractive plastic cabinet; the aerial, ground, and headphone terminals are mounted on the back. When the tuning knob is turned, the indicator moves across the scale observed in the window in the front panel. This set needs a long aerial (100 to 150 feet) and a good ground connection, preferably to a water pipe. Signal strength depends largely on the grade of headphones used.

The tuning condenser varies the capacity across the secondary coil of the aerial coupler. The loosely coupled aerial coil helps to improve the selectivity. No batteries are required and no detector adjustment is necessary. Reception thus becomes a very simple matter. The crystal detector is a 1N36 type. A small fixed condenser is connected across the headphones.

A wristband radio

The Da-Myco "Dick Tracy" wristband receiver illustrated in Photo C is one of the latest and smallest tunable sets to make its appearance. The photo shows the compact manner in which the designers have built this receiver, which even has a tuning inductor stowed away inside the phone shell. The headphone has a steel magnet and a single coil of about 1,000-ohm resistance, mounted on a soft iron core at its center.

The tuning coil has an iron slug in-

THE CRYSTAL RADIO MAKES A COME-BACK

(Continued from page 33)

side it to boost its inductance. A slider moves across the turns, over a path cleared of insulation in one of the simplest and oldest of tuning circuits. The tuning lever moves in a slot cut through the side of the case and terminates in an

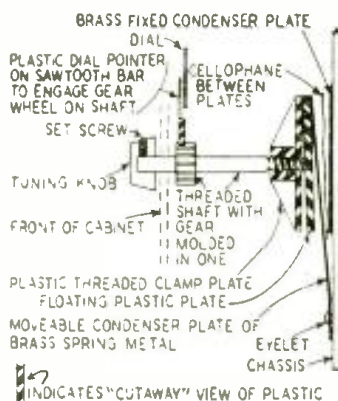

Fig. 3—Detail of Revell radio condenser.

insulated knob. The fixed crystal detector is of the radar type (germanium) and requires no adjustment. A fixed condenser is shunted across the headphone.

Two jacks are provided in the side of the case to which aerial and ground connections are made. As with all other crystal sets, the longer and higher the

aerial, the better the reception. For apartments and other locations where it is not convenient to erect an antenna, a compact aerial device is available which plugs into any convenient outlet. This device consists of a condenser and a suitable inductor which bridges the set across the lighting circuit; no current passes through the set.

References:

- Diode vs Crystal Detector, RADIO-CRAFT, Jan., 1946.
- Loud Crystal Reception, J. D. Amorose, RADIO-CRAFT, Sept., 1945.
- Interflex (Short-Wave) Crystal and 1 tube set, RADIO-CRAFT, Oct., 1943.
- Crystal Signal Tracer, RADIO-CRAFT, May, 1944.
- Crystal Receiver (Short-Wave), RADIO-CRAFT, March, 1943.
- Crystal Works Loud Speaker, RADIO-CRAFT, May, 1943.
- Crystal Diodes, with table of fixed crystal detectors, RADIO-CRAFT, March, 1946.
- Link-Coupled Crystal Set (with superior selective tuning), Carroll Utermahlen, RADIO-CRAFT, Sept., 1946.
- A Modern Crystal Set, W. J. E. Spain, RADIO-CRAFT, Dec., 1946.
- Germanium Crystal Probe, R. E. Altomare, RADIO-CRAFT, Sept., 1946.

AMAZING NEW RADIO!

Pocket or Purse size

SMALL AS A PACK OF CIGARETTES! Weighs only a few ounces—Beautiful black chrome plastic case. Uses new crystal diode. Hi-Quality dial. No tubes, batteries or electric "plug-ins" required! Receives local broadcasts and

QUARANTEED TO PLAY when used according to instructions sent with each radio! You can use it at home, in many offices, hotels, cabins, in bed, etc.—lots of fun—real entertainment!

Send Only \$100 (cash, money order, check) and pay postman \$2.00 plus delivery fees on arrival or send \$3.00 for postpaid delivery. Complete as shown ready to play with self contained personal phone. For GIFT—children will love it—grown-ups too! An exceptional value—order yours and enjoy the many good radio programs coming! Don't be without your Pa-Kette Radio another day! (All foreign orders \$5.00 U.S. cash.)

Pa-Kette Electric Co. Dept. RC-7 Kearney, Nebraska

FREE! Send for it NOW!

ALLIED'S 164-PAGE RADIO CATALOG



RADIO'S MOST COMPLETE BUYING GUIDE!

LARGEST STOCKS SPEEDY, EXPERT SERVICE!

Send for your FREE copy of the most complete Buying Guide for Everything in Radio. Features thousands of radio and electronic parts, latest home radios, sound systems, amateur gear, builders' kits, servicemen's equipment, tools, books—world's largest stocks of quality equipment—all at lowest prices! Expert help; fastest service!

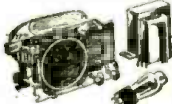

More than 10,000 items—Complete lines of all leading makes. Largest stocks of hard-to-get parts. Lowest money-saving prices. Get everything you need in Radio from ALLIED!



Public Address—entirely new line—new styling, new design features. Packaged Ready-to-Use Sound Systems; everything in amplifiers, speakers, mikes, intercom and recording.



Amateur Gear—immediate delivery on latest communications receivers. Time payment plan; trade-ins accepted. Headquarters for all ham and experimenters' needs.



Handy Radio Books

Radio Formulas and Data
Dictionary of Radio Terms
Radio Circuit Handbook
Radio Builder's Handbook
Simplified Radio Servicing
Radio Data Handbook

ALL SIX BOOKS No. 37-799 . . . \$1.00
Parallel Resistance and Series Capacitance Calculator, No. 37-960 . . . 25c
R-F Resonance and Coil Winding Calculator, No. 37-965 . . . 25c

ALLIED RADIO

ALLIED RADIO CORP.
833 W. Jackson Blvd., Dept. 2-G-7 Chicago 7, Ill.

- Send FREE Radio Catalog
 - Send 6 Books No. 37-799
 - Send Calculator No. 37-960
 - Send Calculator No. 37-955
- } enclosed

Name.....

Address.....

City.....Zone.....State.....

V.F.O. EXCITER OR TRANSMITTER

(Continued from page 32)

previously discussed. To calibrate the other half, switch in C3 and set the variable tuning condenser at maximum capacitance. Then vary C3 until 3.5 mc just comes in. In this particular case it occurred when C3 was a parallel combination of two ceramic condensers, a 100- and a 20- μ f unit. Otherwise it would have been convenient to use a 100- μ f fixed and a midget variable of about 35 μ f, adjusting the latter as required. The calibration was made to coincide with the band and it is impossible to operate out-of-limits unintentionally.

The plate circuit of the e.c.o. is tuned to the second harmonic, 80 meters. This provides good isolation and permits a higher stability to be attained. The coil is wound with 42 turns of No. 22 wire on a 3/4-inch polystyrene form screwed to the chassis. A 100- μ f trimmer condenser sets the band and tuning is done with a 50- μ f midget variable. Actually this is a non-critical control unless frequency is changed over a wide range.

Voltage to the 6SJ7 is regulated by a VR-150 and a VR-90 in series. The large screen resistor drops the voltage to about 100. This tube does not become too hot to touch even after operating a long time.

Oscillator output is capacitance-coupled to the buffer 6F6. This tube runs Class A for good isolation. An r.f. choke is used in the plate circuit in series with the dropping resistor. This runs quite hot but is well within its ratings. The plate voltage is about 300 and the screen runs at about 150. If more output is desired this tube may be run at higher ratings.

The 2-tube exciter may be either capacitance- or link-coupled to a multi-band exciter. If the leads are long it is better to use link coupling, using an untuned transformer instead of the r.f. choke in the 6F6 plate circuit.

After experimenting with various push-pull, push-push, and single-ended final stages, the latter was finally adopted, but two tubes in parallel are used for more output. Such a circuit can feed a single wire effectively and is easier to excite than push-pull. The latter does, of course, give slightly higher output for a given input. Type 807 tubes are used in the final. These are now available at less cost than most receiving tubes. They require little excitation, give ample output, and are well shielded. With 400 volts on the plates, output is about 50 watts.

High-frequency parasitics were very much in evidence at the start, as is to be expected from sensitive beam power

tubes. They were completely eliminated by connecting 50-ohm resistors in each screen lead and small chokes in each plate lead. The chokes are made of 15 turns of No. 28 wire wound on (and in parallel with) 10-ohm resistors. Shielding between grid and plate circuits is ample, due to sinking the tubes below the chassis level. The tubes were found to run cooler without shields.

A pi network couples the final to the antenna and gives very satisfactory results. This system permits continuous variation of power input to the final by adjusting the coupling. The tank coils are wound to resonate in the desired band when both coupling and tuning condensers are at half capacitance. This is done because an increase in capacitance of one condenser must be accompanied by a decrease in the other to maintain resonance.

The coils L for the pi network are space-wound with No. 22 wire on plug-in forms 1 1/2-inch in diameter. There are 38, 15, and 6 turns on the 80-, 40-, and 20-meter coils respectively. Length

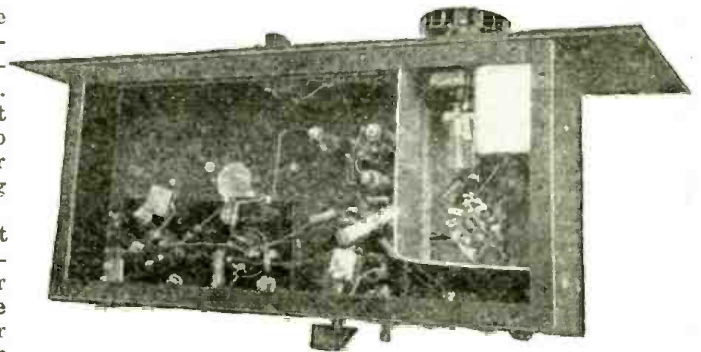

L2 and its air end mica condenser are well seen at bottom center.

of winding is 2 inches on the 80, 1 1/2 on the 40 and 1 inch on the 20-meter coil.

Choice of either oscillator or final keying is provided. Many amateurs prefer the latter in order that there will be no interruption of the oscillations. Oscillator keying permits break-in operation; however it is necessary to add a C-battery or cathode bias resistor to prevent overloading the 807's.

Calibration and operation

After the rig has been completed and tried out is a good time to calibrate the main dial. A 100-kc crystal oscillator (preferably checked with WWV) is good for this purpose. To obtain 100-kc markers through the 80-meter band, crystal harmonics are caused to beat against the v.f.o. signal while listening in on a shortwave receiver. If the latter is tuned to 80 meters, zero beats will be heard at 3.5, 3.6, 3.7 . . . kc and these points can be marked on the v.f.o. dial. To obtain 50-kc markers, the receiver is tuned to 40 meters. Here again zero beats are heard every 100 kc, that is, 7.0, 7.1, 7.2 . . . , but the first corresponds to 3.5 on the v.f.o. dial and the second is a harmonic of 3.55. In other

words, the calibration now may be made every 50 kc on the 80-meter v.f.o. dial. Tuning to 20 meters will provide a marker every 25 kc, and so on. Since the scale is practically linear, it is hardly necessary to go so far.

To put the rig on the air on 80, the main dial is set to the desired frequency with the switch under the dial thrown to the proper range. The buffer condenser is used as a trimmer and is adjusted for minimum reading on the panel meter. This indicates maximum excitation to the final grids. The antenna-coupling condenser is then set to

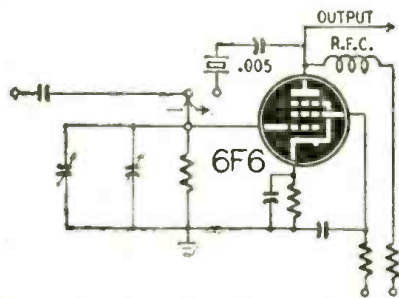

Fig. 2—Switching circuit for crystal control.

the desired loading and the tuning condenser is resonated for lowest meter indication. If this reading represents an input lower than that desired, the coupling condenser is set at a lower capacitance and the other condenser returned.

The panel meter is calibrated directly in watts input rather than conventional plate milliamperes. A resistance-wire shunt is adjusted across the 1-ma meter until full-scale deflection corresponds to 250 milliamperes. Since the plate voltage is 400, full deflection is equal to 100 watts input. Furthermore, power is proportional to current when the voltage is kept constant, therefore the meter reads in watts. For example, if the indication is 0.47 it is equal to 47 watts. With the circuit constants shown in the schematic, maximum (off-tune) input is about 100 watts. Don't permit the transmitter to remain in this condition for long.

Most QSO's will probably be on a single frequency for both reception and transmission. If the final is keyed, this means that the local transmitter oscillator will interfere with the incoming signal. The toggle switch under the v.f.o. dial can be used to good advantage here. After transmitting on the desired frequency, throw the switch; this changes the frequency but does not interfere with oscillations. However, don't forget to throw the switch back again before transmitting!

A flexible frequency is handled more conveniently when a rig contains few controls and circuits, and in any case the signal stability is best at low harmonics of the oscillator frequency. For these reasons and to keep the rig from becoming too complicated, no doublers have been incorporated. However, the buffer circuit resembled a Pierce crystal oscillator so much that we couldn't resist trying it out that way (without affecting the v.f.o. channel in any way, of course). All that has to be added for alternative crystal control is a socket,

NOW! Walter Ashe gives you BIGGER-THAN-EVER TRADE-IN ALLOWANCES on your used Receiver or Test Equipment



YOUR TRADE-IN'S WORTH MORE AT THE WALTER ASHE STORE

You'll be amazed at the extra-liberal allowances Walter Ashe gives you. Here's your chance to exchange for brand new, big name merchandise at a fraction of its value. You'll save yourself money if you take advantage of this opportunity now. Don't put it off! Wire, write or phone today.

NEWEST RECEIVERS!

National HRO (less power supply and speaker)	\$274.35
National NC-240-D (less speaker)	225.00
National NC-46 (less speaker)	97.50
National NC-173	179.50
NC-173 Speaker	10.00
RME-45 (with speaker)	198.70
RME-84	98.70
Hammarlund HQ-129X (with speaker)	173.25
Hammarlund SPC-400X	342.00
Hallcrafters SX-42	275.00
Hallcrafters X-40	89.50
Hallcrafters S-38	47.50

Prices subject to possible change.

TEST EQUIPMENT FOR FAST TRADE!

Mickok	Waterman
Jackson	Du Mont
Precision	Feiler
Simpson	Melissner
McMurdo Silver	Triplet
Radio City Products	Reiner
Robson-Burgess	RCA
Chicago Industrial	Bliley
Special Products Co.	Manlan
Industrial Instrument	Monitor Piezo
Cornell-Dubilier	Weston
Coastwise Electronic	Sprague

RCA 1 KW MODULATION XFORMER
Heavy Duty modulation xformer. 10,000 ohm pri. plate to plate. Dual secondary. #1 450 MA. for plate. #2 80 MA. for screen of beam power tubes. \$14.95

SUPER BARGAIN

SURPLUS CHOKE
4.5 Hy. 150 MA filter choke. Very conservatively rated 70 ohms DC res. 3" x 3/4" x 4". Metal case. \$1.29
Standoff insul. Moisture Proof



NEW CALL LETTER PINS

Make your Ham call known. Wear a call pin, or any ten letter name. Durable chrome letters on blue, black or red background. Maximum of ten letters per line.
2 line pin. \$3.25
2 line pin. \$1.75
• Talk about Service! All orders shipped the day we get 'em!

NEVER BEFORE IN PRINT

20 STEPS TO PERFECT AMPLIFICATION

SEND 2c STAMP FOR POSTAGE

AMPLIFIER CORP. OF AMERICA

398 Broadway,

New York 13, N. Y.

blocking condenser, toggle switch, and, of course, a crystal (Fig. 2). This makes it possible to change to crystal control at will and easily.

The output of the single-tube oscillator is slightly greater than that of the 2-tube v.f.o. unit. There is ample excitation to the final stage so that it can operate as either a doubler or a tripler with suitable crystals. We can even get

SPECIAL! SPECIAL! SPECIAL!

PHONOGRAPH MOTORS
Constant speed synchronous 60 cycle rim drive motor with 9" turntable. Original cost to phone mfg: \$5.50. Our spec. \$3.75
General Industries Model "J" two speed motor with turntable. 33 1/3-78 RPM. \$15.90

\$3.75

ARMY SURPLUS HEADPHONES

Type HS-23
8000 ohms impedance. Adjustable leather headband. Rubber cushions. Brand new in original box. \$1.29

SURPLUS FILTER CONDENSERS

An honest bargain. 2 Mfd. X 5000 V. Dykanol. Mounting bracket and husky standoffs. Regular \$29.00
SPECIAL \$7.51
New 2 Mfd. X 4000 V. Oil filled. Metal can with standoffs and brackets. Regular \$25.44
SPECIAL \$4.50

SCOPE TRANSFORMER

2100 volt @ 10 MA
sec. 115 volt 60 cy.
pri. shielded metal case with stand off insulators \$4.25

HAND MIKES

BRAND NEW!!
Shure T-17, S.B. Carbon
Sturdy. Efficient
NET EACH \$1.49

AMPLIFIER CHASSIS WITH COVERS

#3971 Deluxe. 5 1/2 X 10 X 9.
Regular net \$3.69. \$2.77
Our special price
#3983 Standard 10 X 14 X 9.
Regular \$3.71
Our special price \$2.64
(Limited quantity)

SURPLUS NAVY PUBLIC ADDRESS HORNS

Weatherproof, corrosion resistant, 15 watt handling capacity 15 ohm input \$19.95

RG-8/U BRAND NEW SURPLUS 51 OHM COAX

Under 100 ft. \$0.06 ft.
Over 100 ft. \$0.05 ft.
1000 ft. or more \$0.045 ft.

MEISSNER KITS IN STOCK

6 tube 2 band super het kit, complete with tubes \$24.70
less cabinet
3 tube AC-DC TRP kit less tubes \$8.04
Kit of tubes for above \$2.22

REVERSIBLE MOTOR

50 inch-pound torque. 1/2 to 2 r.p.m. Conversion instructions for rotary beam drive and use on 115 VAC. \$4.95

NEW SHIPMENT!!!

Surplus throat mikes. 220 ohm button. Comp. pare and save! \$0.35

WQCTF WQJWD WQWTM WQPCI WQULH WQNRH WQQDF WQJYD

Walter Ashe RADIO CO.
1125 PINE ST. • ST. LOUIS, MO.

PEN-OSCIL-LITE

Extremely convenient test oscillator for all radio servicing. alignment • Small as a pen • Self powered • Range from 700 cycles audio to over 800 megacycles u.h.f. • Output from zero to 125 v. • Low in cost • Used by Signal Corps • Write for information.

GENERAL TEST EQUIPMENT

38 Argyle Ave. Buffalo 9, N. Y.

ROTA-BASE

NEW HANDY LAB. DIAL actually gives a "prong" picture of radio tube connections. Simply turn the dial to the tube number desired on the ROTA-BASE and complete correct connections are instantly indicated on the "prong" diagram. No more valuable time lost thumbing pages or on lengthy readings. Filament, grid, plate, cathode, etc. to MORE THAN 300 tube types are given. PRICE NOW ONLY \$1.00 postpaid or sent C.O.D. plus postage. Order NOW, money refunded if you are not delightfully pleased.
REED MFG. CO. • Los Angeles 13, Calif.

a few watts of 28-mc output from a 7-mc crystal!

LEARN ELECTRIC MOTOR REPAIR!



**A PROFITABLE
ADDITION TO
ANY RADIO SERVICE
BUSINESS**

This big
book shows
you how—every
step of the way—
only **\$5**

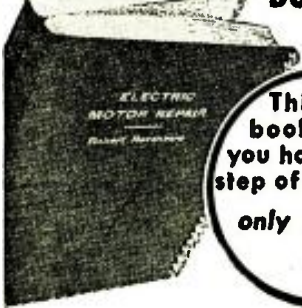

IT PAYS TO SPECIALIZE IN SOMETHING DIFFERENT

There's good money in electric motor repair! The field is not crowded—and what could be a finer more profitable addition to your already established radio service business? Every home you visit on radio work has many motor-driven appliances. Be the man who can repair them!

ELECTRIC MOTOR REPAIR, the unique new book by the publishers of the famous Ghirardi Radio-Electronic books, teaches you the work from the very beginning. Explains every detail of motor trouble diagnosing, repair and rewinding. Covers a-c and d-c motors, synchronous motors and generators and mechanical and electrical control systems.



A "BENCH" BOOK

Based on what you can learn from this big book alone, you can train for prompt, profitable motor service. Quick reference guides for use right at the bench show exactly how to handle specific jobs. Invaluable for beginners or for daily reference in busy shops. Unique Duo-Spiral Binding divides book into 2 sections permitting text and the more than 900 diagrams and illustrations to be seen AT THE SAME TIME.

**"BORROW" IT FOR
5 FULL DAYS!**

Send coupon now! Practice from **ELECTRIC MOTOR REPAIR** for 5 days. If not more than satisfied, return book and every cent will be cheerfully refunded.



NO RISK COUPON mail today

Dept. RC-77, Murray Hill Books, Inc.
232 Madison Ave., New York 16, N. Y.

Enclosed is \$5 (\$5.50 foreign) for a copy of **ELECTRIC MOTOR REPAIR** Book; or send C.O.D. for \$5 plus postage (no foreign C.O.D.'s). In either event, if not satisfied, it is understood I may return book in 5 days for complete refund of my money.

Name

Address

City & Dist. No. State

REFLEXED FOUR-TUBER

(Continued from page 20)

denser are installed in the screen-grid circuit.

The 7E7 tube functions as the second detector, a.v.c., and also, when required, as the first audio amplifier in a reflex circuit. It is with the hookup and action of this tube in the circuit that we are primarily concerned.

In the conventional connecting of a diode detector in a radio circuit the high potential of the signal input transformer L4 is connected to one or both of the diode plates. This results in comparatively low gain and poor selectivity for the preceding stage of carrier amplification, because the secondary of its transformer is loaded with the audio signal. These two serious disadvantages of the diode detector are eliminated in the circuit of this set. At the same time the distinct advantages of the diode as a linear detector are retained.

A simple inductance L5 is placed in the cathode circuit of the diode tube, causing cathode voltage to vary with the r.f. signal, and detecting it on the cathode's negative half-cycles.

The value of L5 should substantially equal the carrier frequency. In other words, it should be large enough to resonate at about 456 kc when the i.f. is 456 kc. A spare i.f. winding with several turns added will work, or a 2.5-mh radio-frequency choke coil will serve the purpose. The larger the coil, the greater will be the gain and selectivity, but this must not be carried so far as to produce instability in the set.

L5 is not tuned, and should be shield-

ed if necessary, though if carefully placed, shielding should not be required.

The secondary of L4 is connected directly to the control grid of the 7E7 tube. To prevent loading of this transformer, and thus to secure the greatest gain and increased selectivity, the control grid must be maintained at a negative voltage greater than the incoming peak signal voltage. The negative bias and a.v.c. provided in this circuit are intended to do just that.

A novel and thoroughly practical feature of this set is the use of two variable controls, R5 and R12. Each should be a minimum of 1 megohm, and for better results may be 2 megohms. Each has a tone tap, preferably near the center but not less than 500,000 ohms up from the bottom.

The schematic clearly indicates the proper connection of the two controls in the circuit.

R5 in the detector circuit is used to cut the reflex feature in or out at will. When the center arm *b* is moved to a position between *c* and *a* the audio signal is reflected to the control grid (No. 6) of the 7E7 tube, thus making it the first audio amplifier. When this is done the center arm *b* of R12 is moved to a position near *a* of that resistor. Now not only volume but tone as well can be controlled. For example, if the volume is lowered by adjusting R5 and correspondingly increased by adjusting R12, the resulting tone will have a lower pitch, and much noise will be eliminated.



"What kind of current does it use—A.C. or B.C.?"

Suggested by R. C. Redmond, Auburn, N. Y.

The first audio amplifier is eliminated when the center tap *b* of R5 is moved to a position between *c* and *d*. In this case the center tap of R12 is moved to *c* for the loudest signal, and thereafter the volume is controlled by R5.

For local stations by day and most stations by day or night the first audio amplifier will not be required for reasonable volume and the best in radio reception. The additional audio amplification will be undesirable also when headphones are used.

When properly constructed and accurately tuned the selectivity of this set is high. In this connection it must be remembered that the i.f. transformers cannot be tuned with a metal screw driver. A nonmetallic driver such as can be made from a plastic toothbrush handle is a necessity.

When building this or any other radio set it is well to keep in mind certain fundamentals: Use good parts. Keep grid and plate leads as far apart as practicable; also keep these leads as short and direct as is convenient. Keep all leads close to the chassis or other grounded parts. Make sound soldered connections.

When more than 100 volts is available for the B-supply it may be necessary to install appropriate resistors and by-pass condensers in the screen-grid circuits.

Use good components and careful work in the audio end.

No amount of effort applied on the detector circuit will compensate for poor performance of the power amplifier or for a poor, mismatched or low-quality speaker.

In connection with the foregoing, and especially for beginners, attention is directed to the excellent article "Problems Underlying Construction of a 5-Tube Superhet," by H. A. Nickerson, page 24, RADIO-CRAFT for October, 1946.

A set that fails to bring in far distant stations regularly should not be condemned for that reason alone. The fault may be due to atmospheric conditions which may continue for several days at a time. So do not be in too big a hurry to tear up your set.

NOTES ON SERVICING (Continued from page 58)

circuit diagrams of the set under repair, the voltohmmeter, a signal generator, tube tester, and the usual tools. A beginner can locate trouble in a set more quickly with a signal tracer (usually a t.r.f. set which has a probe to connect at any point on set under test and gives an audible signal or operates an "electric eye") than the experienced service man with his voltohmmeter and great experience.

Too many servicemen stop with replacement of a defective part. An effort should be made to put the set in top-notch condition by adjustment of trimmer condensers and alignment of superheterodynes, cleaning out variable condensers, the addition of baffles, lubrication of bearings, addition of shields and condensers when needed.

"TAB" Electronic Parts

New Guaranteed That's A Buy

TEST SET 268U CRYSTAL RECTIFIER CHECKER



TESTS CRYSTALS IN 21, 21A, 21B, 23, 23A, 23B, 25, 25K OTHERS. WESTON MULTI-COLORED ENGLISH READING SCALES ON 3 1/2" SQ. BAKELITE MTR. TESTER CHECKS FORWARD & BACK RESISTANCE IN KILOHMS & BACK CURRENT CHECKS BRITISH CRYSTALS. TESTER COMES COMPLETE IN CRACKLE FINISH NAVY CAST ALUM. CASE 3 1/2" x 7 1/2" x 3 1/2" WTS. S.P. parts WATERPROOF INSTRUCTIONS, MANUAL BATTERY INCLUDED, PACKED FOR OVERSEAS SHIPMENT, NAVYINSPE. (G Cost \$125) Gtd SPECIAL \$15.95

CRYSTALS New IN 21, 22, 23, 25 @ 2.49
CRYSTAL IN 34 PENNSYLVANIA \$1.39 @ 2 for 2.49
DYNMTR 12/24V inpt 500V/50ma out 1.95
DYNMTR 12/24V inpt 275V/110ma @ 1.95
12V/3A out 12Vinpt/500V/50ma-275V/110ma in & out alt 4.95
KIT ASSTD SPAGHETTI 75 Feet 1.00

TRANSF 5V/115amp KENYON 115V/60c Pri 7.95
1000V/45ma 705VCT/80ma. 3x5V/3A 6.3VCT/1A.6.3V/3A. 115V/60c. Cased HV \$7.95
1100VCT/212ma. 115V/60c. Cased 6.50
110-220 to 220-440/100WATT'S RATIO TR 4.95
CONSR OIL GTD RATED WVDC 4mfd/50, 10for\$2; 2mfd/800. 2 for .79
4mfd/800, 2for\$1.25; 10mfd/800. 2 for 2.50
20mfd/600, 2for\$4.95; 15mfd/1000. 2 for 2.95
2mfd/3000 \$3.00; 4mfd/3000 5.00
BC 1253 RADIOSONDE TRANSMITTER .97

COLLAPSIBLE TELESCOPIC ANT-AN30 12"top 1.49
ANTENNA SCM50/19 ft. MTC&base 4.95
AMATEUR RANDOM BAND FREQ XTALS 2 for 1.00
COILS & CRYSTALS BC611 HANDI-TALKIE SET 1.95
HANDI-TALKIE BC611 CHASSIS & COILS & XTALS 7.95
AUTO-TRANSF 115V-or-230V/50-60cy-1400Watts 19.95
OSCILLOSCOPE 3" KIT Tubes & pwr supplies 16.95
TELEVISION TRANSF 2500V/12ma 115V/60C 5.95
TRANSF 1500V/35ma Pri 115V/60 cy 15.95
TRANSF 980V/32ma Pri 115V/400C wks 60cy 9.95

Headset 1000ohm 8ft cord & PL55 plug 2.95
CRYSTAL STD 200KC Vacuum 10cy acy 5.95
STROBO FLASH TRANSF 1340V/115V/60cy 4.95
STROBO FLASH COND SR 32mfd/660AC/2000WV/4Sec 7.95
PRECISION ONE MEG W.W.1% Resistors 3 for 2.10
FOR CHOKE CASED H.V. INSLTD 12 Hy/300ma 2 for 5.50
PP6L6/5000 ohm HIFI Multi-Tap-sec 3.95
CONDERS OIL 2MFD/2000VWDC 2 for 3.98
H Cased 1.49
Transf 115V/60cy-1230VCT/262 ma H Cased 5.98

RAYTHEON VOLTAGE REGULATOR

Cased New S. C. Tropicalized

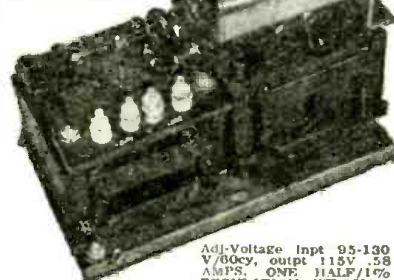

Adj. Voltage Inpt 95-130 V/60cy. Output 115V 50 AMP. ONE HALF/1% REGULATION. WT-20Lbs. RUGGED. DESGN. TAB SPECIAL \$14.95

6 1/2" H 8 1/4" L 4 3/4" W OVERLOAD PROTECTED
866AS COMBINATION TUBES, TRANSFORMER & SOCKETS 5.95
TRANSFORMER 866A'S ONLY 3.95
872A'S COMBINATION Tubes, TRANSF, Sockets 12.00
WRITE FOR TUBE, TRANSF, CHOKE & COND SR CATALOG

"DB" METER Westing-house



RC35 3 1/2" BAKELITE CASE SQUARE MODERNISTIC APPEARANCE. RECTIFIER TYPE RANGE MINUS TEN PLUS SIX DECIBELS. CAL FOR 1/2" STEEL PANEL 0-DH 6 MW IN. 600-ohms AT 1000cys. P.S./3.75 VAC NEW GTD IND BOXED WITH HD WARE. SPE. \$4.95
CIAL "TAB" PRICE TEN FOR \$42.50
TWO FOR \$9.00

DE JUR ONE MILLIAMPER 2 1/2" B'C 2.50
GE ONE AMP OR 5 AMP HF MTR 2.95
GE 2000 VOLTMETER 1000 ohm/V 2 1/2" B'C 4.95
WESTON 475 SO 3" B'C 1.5 VAC 4.25
AIRCRAFT AUTOSYN INSTRUMENTS USED IN BENDIX PIONEER FUEL PRESSURE INDICATOR (S125) 6.95
B/P OIL PRESSURE 6007-4H-14A INDICATOR 6.95
B/P MANIFOLD PRESSURE 6007-50A-14A IND. 6.95
AUTOSYN AV1&5 paired Indicators 18-24V/60C 3.95
GE 2 1/2" MANIFOLD PRESSURE 3 1/2" B'C 3.95
DUAL AN INDICATOR 200 microm. no 0 adj 1.95

KIT SILVER & MICA CONDENSERS .50 for 2.00
KIT CONTROLS 50-2mexonns POTS. 10 for 2.50
KIT RESISTORS 1/2 & 1 WATT 50e2 megohms 100 for 2.50
KIT VITREOUS WW RESISTORS 100 for 4.95
KIT POWER RHEOSTATS 25x50 WATT 6 for 1.75
KIT ROTARY SWITCHES 6 for 1.25
KIT KNOB ASST WITH BUSHINGS 25 for 3.95
KIT FUSES ASST BUSS & LITTEL-FUSE 300 for .99
KIT HARDWARE GOOD ASSMNT ONE POUND 99
KIT MOTOR BRUSHES 100 ASSTD 99
KIT GROMMETS RUBBER 100 ASSTD .99

VACUUM CONDENSERS 100mmf/-7500V 4.95
VACUUM CONDENSERS 50MMF/-7500V 4.50
VACUUM CONDENSERS 50MMF/-20000V 6.95
BENDIX GYRO-SERVO MECHANISM 14.95
FOXBORO MECHANICAL 115V/60cy RECORDER 39.95
BLOWER AIR 115V/60C inpt 200cuftm Dual 13.95
BLOWER AIR 28VDC/AC INPT 120 Cu ft M 4.95
BLOWER AIR & TRANSF 115 VAC/100cu ft M 5.95
WE DYNAMIC BEACHMASTER MIKE 20 ft. CABLE 7.95
SYNCHROSCOPE SP3 OSCILLOSCOPE COMPLETE 49.95

IF STRIP 60mc's/85DB gain 8/6AK5 \$9.49
1/8ALS oupt & inpt plug & Jack 3.49
S2E STRIP LEAS TUBES 13.95
CW3 RCVR COMPLETE 115V/60C 2.79
CW3 & F3 WILCOX RCVR COILS 5.1/10mc's TEST SET OSCILLATOR TM 61058 RF SIG OSCILLATOR LABORATORY INPT 15 25mc's & 180-230mc's inpt 115V AC/60cy 50P/BENDIX 50/80cy PAIRED 110VIN 8.95
GR VARIAC 200cu/860WATT/0to135V output 14.95

Speech Amplifier Complete

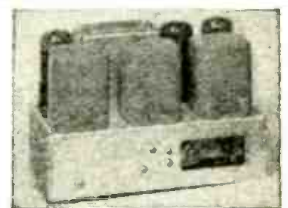

MINUS TUBES & POWER SUPPLY DYNAMIC OR CARBON MICROPHONE OR LINE INPT FEEDS PLUS B GRIDS. NOISE LEVEL .55DB. Includes Inpt Transf. 1st audio to PPGrids Driverstage 6V8 & DriverTransf. to PPGrids. Modulator tubes 6V6 (dialtone adj) audio osc Amp & Hdphone monitoring Jack. TAB SPECIAL With 2/0V6 & 6SJ7 7.49

GUARANTEED USED S.C. & NAVY EQUIP. CRYSTAL CALIB SIGGENERATOR 8-15mc's & 450/77mc's—2nd, 3rd & 4th harmonics usable coverage to 230mc's. consists of 6J3XTA, Low 900Det, 2/6SJ7 Amp, 9002 Var Two Harms osc 4V3G PW rectifier. attntr 10000ohm/50volts 115V/60cy operation. Rugged, design 34.95
BC312 RCVR 1.5 to 18mc's 115V/60C 28.95
BC312 RCVR 1.5 to 18mc's 115V/60C 28.95
UTC R Hy/100ma New Cracked Bakelite T/B 89

BC312 RCVR 1.5 to 18mc's 115V/60C 28.95
UTC R Hy/100ma New Cracked Bakelite T/B 89
\$2 Min. order FOB N.Y.C. Add Postage all Orders and 25% deposit. Worth 2-7230. Send for catalog 99. Specialists in International Export, School, College and Industrial trade. Moneyback "TAB" Guarantee.

"TAB" • Dept. 7RC, 6 Church St., New York 6, N. Y., U. S. A. • "TAB"
★ ★ ★ ★ CORNER CHURCH AND LIBERTY STS., ROOM 200 ★ ★ ★ ★

JULY LEONE SPECIALS

DPDT Toggle Switch (C-B) 20A/125V. Bat handle, one side momentary. Screw lugs. 1 1/2" sq.; 1 1/4" deep .39 10 for 2.95
44" Whip Antenna. 4 brass sections telescope to 13 1/2". Locks open. Suitable dipole section .49
SELECTING RECTIFIERS. Half-wave. 50V. AC @ 1 amp. With hook-up diagram for half or full-wave rect. Each—69c. 4 for 2.49

"DUNCER" INPUT TRANSFORMERS
(7/8"x1-3/16")
Dynamic mike or low impedance pickup to grid .49
12 for .500

Midget Audio Transformer. 3:1 ratio. Ideal for interstage audio osc. etc. 1 X 1 1/2"x2" .39

Telegraph Key & G.V. Buzzer (Western Electric). Gap & tension adjust; 1 1/4" bakelite base .125
Key only. Platinum contacts .49

PHONO MOTORS!! Twin-coil 110V. AC quiet rim-drive, fan cooled. With deep flocked 9" turntable 2.95

TUBES: Perfect condition, but not in sealed cartons. Guaranteed for 90 days.
#26, 27 or 56-29c; #42, 43, 75, 77, 78, 81, 89, 9H6 or 6K1 .39
#6A8, 6C5, 6F5, 6H, 6SA7 or 6XK1 .49
#1A7, 6A3, 6X5, 6U3 or 5U .59

ALNICO MAGNETS

#1 #2 #3 #4 #5 #6 #7 #8 #9 #10 #11 #12 #13 #14 #15 #16 #17 #18 #19 #20 #21 #22 #23 #24 #25 #26 #27 #28 #29 #30 #31 #32 #33 #34 #35 #36 #37 #38 #39 #40 #41 #42 #43 #44 #45 #46 #47 #48 #49 #50 #51 #52 #53 #54 #55 #56 #57 #58 #59 #60 #61 #62 #63 #64 #65 #66 #67 #68 #69 #70 #71 #72 #73 #74 #75 #76 #77 #78 #79 #80 #81 #82 #83 #84 #85 #86 #87 #88 #89 #90 #91 #92 #93 #94 #95 #96 #97 #98 #99 #100

#1—Bar, 8 1/2"x5 1/2"x1/8" .59
#2—Face 1 1/4"x1 1/4"x7/8" high .88
#3—Heavy duty bar, 2 1/2"x1 3/8"x5 1/2" .98
#4—Face 3/4"x3/4"x3/4" .15
#5—Polished, 1 1/2"x9/16"x3/8" high .15
#6—Polished bar, 9/16"x1 1/4" .20 for 1.00
#8—ALNICO V. h. shoe, poles 3/8" sq. 1 1/4" high .75
#10—ALNICO V. h. shoe, poles 1"x1 1/2" 2 3/4" high. (shp. wt. 3 lbs.) 5.95
#12—Similar to #10, 2 1/2"x3/4"x7/8" high .35
#15—Polished block, 3"x2 1/2"x1 1/2" magnetized wide or narrow sides. (Wt. 3 lbs.) 2.49
#17—Circular, 1 1/16" O.D. 1/8" I.D. 1.95
#18—Circular, 5/16" deep .49
#19—Round bar, 1 1/2" O.D., 7 1/2" high .12
#21—Round bar, pol., 3/8" O.D., 4" long .35
#23—Round bar, pol., 3/8" O.D., 2 1/2" long .59
#25—Round bar, pol., 3/8" O.D., 1 1/2" long 1.49
#27—Polished block, 3"x2"x1 1/2" .39
#20—Circular, pol., 2 5/8" O.D., 1 3/4" I.D., 1 1/8" deep 1.69

RADIO HARDWARE TREASURE. An indispensable assortment of approx. 1000 screw nuts, washers, lugs, etc. .49
VARIABLE CONDENSERS. 2 gang. 365 mfd. Ball-bearing shaft. 3/4" long .75
HEADPHONES (Army HS-33). 2000 ohms. Leather covered, adjustable. With PL-54 plug .39
Rubber phone cushions. Per pair .25
HEADBANDS (HB-7) with PL-54 plug & cord PL-54 plug & 13" tipped double cord .19
JK-28 ext. jack for PL-54 .23
EXPERIMENTAL TUBES. 20 asstd. receiving types for testing, research, etc. Filament tested 1.00

SERVICEMEN'S KITS

#1—R.F. Antenna & Osc. coils. 10 asstd. .98
#2—Speaker Cones: 12 asstd. 1" to 1 1/2" moulded & free-edge unglue incl. Less voice coils 2.00
#3—BAKELITE MICA CONDENSERS. 50 asstd. .00001 to .2mfd., 200-600WV. Clearly marked 2.95
#4—TUBULAR BY-PASS CONDENSERS. 50 asstd. .001 to .25mfd., 200-600WV 2.49
#5—Walter Sockets. 12 asstd. 4 to 7 prongs .25
#11—Shield Cans; 15 asstd. for coils, tubes, transformers, etc. 1.00
#12—Mica Padders & Trimmers; 15 asstd. incl. multiple & ceramic base types .69
#14—Volume & Tone Controls; 10 asstd. wire-wound & carbon. Less switches 1.49
#15—Wire-wound Resistors; 15 asstd. ohmmages. 5 to 20 watts .98
#16—IF Coils; 6 asstd. including shielded & slug-tuned. Pkgs unmarked 1.25
#17—DIAL WINDOWS; 12 asstd. sizes incl. flat & moulded acetate & convex glass 1.29
#18—Bakelite Coil Forms; 18 asstd. popular sizes up to 3" diameter .98
#19—High Resistance Units. 25 asstd. carbon & wire. ferrule-end. 25K to 5 meg. .49
#21—Metal Cased By-Pass Condensers; 10 asstd. paper-wound, multi-section. 200-400WV .49
#22—Resistor Assortment; 20 carbon & wire-wound, asstd. ohmmages 1/3 to 3 watts .49
#23—RADIO CEMENT & SOLVENT KIT. 3 oz. each of all-purpose cement & thinner. With brush .69
#24—Shaft Extenders, Reducers, Couplings; 10 asstd. most popular types used in servicing 1.29
#25—SPRING ASSORTMENT. 60 asstd. compression & expansion for dials, push-buttons, relays, etc. .98

PROMPT SERVICE ON ALL SPEAKER & PHONO PICK-UP REPAIRS
Minimum Order \$2.00—20% Deposit Required on All Orders. Please Add Sufficient Postage.

LEONE RADIO CO.
MAKERS OF CONES AND FIELD COILS
65-67 DEY STREET, NEW YORK 7, N.Y.
WORTH 2-0284-5
12,000 SQ. FT. OF RADIO PARTS

250-WATT FM-AM TRANSMITTER

(Continued from page 31)

age developed across the capacitor, or from the 6SJ7 grid to ground, lags the oscillator tank voltage by approximately 90 degrees. This lagging grid voltage causes the 6SJ7 plate current to lag the oscillator tank voltage by approximately 90 degrees and the tube then appears as an inductance in parallel with the oscillator tank circuit. The frequency of the oscillator will then be increased.

When the transconductance of the 6SJ7 modulator tube is varied by an a.f. signal voltage applied to its control grid from the 6SN7-GT speech amplifier, the magnitude of the inductive reactance across the 6F6-G oscillator tank is caused to vary at an audio rate. This change in inductive reactance causes the oscillator frequency to be varied at a rate which depends upon the frequency of the audio modulating voltage and by an amount which depends upon the amplitude of that voltage. If the circuit values as given here are carefully followed, the 6SJ7 reactance-tube modulator will give linear frequency modulation and produce many times as much deviation as will be required for amateur communication.

Frequency-stabilizing circuit

The 6HG, the 6SA7 and the 6C5 tubes function as a correction or stabilizer circuit to stiffen the frequency shift or deviation of the 6F6-G oscillator during the periods of frequency modulation. It will be noticed that the grid of the 6SJ7 reactance-tube modulator is returned to ground through two isolating resistors of 500,000 ohms each and the two 100,000-ohm resistors connected across the 6HG discriminator output circuit.

As mentioned above, any change in the transconductance of the 6SJ7 will cause an effective change in the oscillator tank circuit inductance and thereby cause a corresponding change in the oscillator frequency. The *direction* of the frequency shift, i.e., to a higher or lower frequency, will depend upon the *polarity* of the voltage applied to the control grid of the 6SJ7 tube; the *amount* of the frequency shift, i.e., the number of kilocycles, will depend upon the *magnitude* of the 6SJ7 control-grid voltage.

The r.f. voltage at the grid of the TB-35 will be fed, in proper proportion, to the signal grid of the 6SA7. The 6C5 tube is connected as a Pierce crystal oscillator, operating on a frequency of 7,000 kc; its output is fed to the injection grid of the 6SA7. When operating on FM, the 6F6-G grid circuit will be tuned to a frequency of approximately 3,675 kc and the 6F6-G plate and TB-35 grid circuit will be tuned to *twice* 3,675 kc, or 7,350 kc. Now, if we mix the 7,350 kc and 7,000 kc signals we shall obtain in the plate circuit of the 6SA7, a beat frequency or "i.f." equal to the difference between 7,350 kc and 7,000 kc or 350 kc.

The 6SA7 output signal voltage is fed to the primary of a tuned discriminator

transformer adjusted for resonance at 350 kc. Connected to the secondary winding of the discriminator transformer is a 6HG diode rectifier tube. Two load resistors of 100,000 ohms each are connected in series across the cathodes of the 6HG tube with the d.c. return from

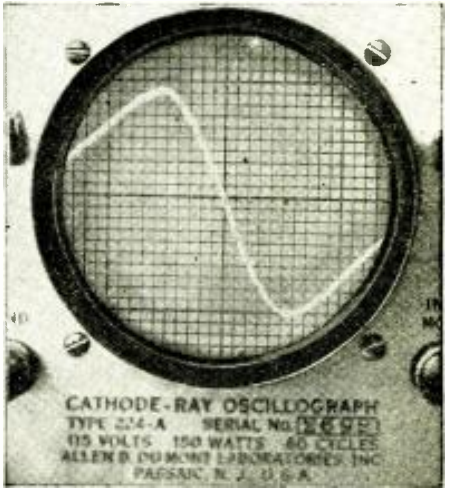

Fig. 2—Discriminator curve. Center is 350 kc; left: higher frequencies, right: lower.

the discriminator transformer secondary winding center tap connected to the resistors.

As long as the i.f. signal remains exactly 350 kc, equal signal voltages will be applied to the two diode plates, equal currents will be drawn and equal and *opposite* voltage drops will appear across the two load resistors. Under these conditions, the net d.c. voltage output from the discriminator will be zero, and consequently no change in the transconductance of the 6SJ7 will take place. Thus, the frequency of the 6F6-G oscillator will not be affected. However, under conditions of frequency modulation, the 6F6-G oscillator frequency will vary with changes in the amplitude and frequency of the modulating signal. Thus, the i.f. or beat frequency will swing higher or lower than 350 kc. As shown in Fig. 2, for frequencies higher than 350 kc, the discriminator output will produce a d.c. voltage having a *positive* polarity with respect to ground; for frequencies lower than 350 kc, a d.c. voltage having a *negative* polarity with respect to ground will be produced. The d.c. voltage output *vs.* frequency deviation will be linear up to approximately 50 kc each side of center frequency, depending upon the design of the discriminator transformer. This d.c. discriminator voltage is fed back to the control grid of the 6SJ7 reactance tube, causing its transconductance to change so as to correct the variation.

This change in transconductance is reflected into the 6F6-G oscillator tank circuit as a change in inductance and the frequency of this circuit is caused to vary correspondingly.

The second half of this article, describing the oscillator and r.f. sections of the transmitter, will appear in an early issue.

TELEVISION OVER A LIGHT BEAM

(Continued from page 22)

the telecast program is handled by a second light beam comprising the modulated light source at the transmitter, and the second photomultiplier cell at the receiver, feeding into the conventional loudspeaker system. In the demonstrations the two light beams have been paralleled and directed so close together as to overlap in part at the receiving end, yet each is directed by adjustable lenses and mirrors on to the respective photocells. The video and audio reproductions are on a par with the usual electrically transmitted television systems.

The equipment demonstrated so far has established that photovision is practical. Further research promises to make the system applicable to many fields of transmission of images and sound. For example, in the transmission of color television, four color channels may be independently modulated with the red, green, blue, and sound signals for a composite simultaneous color television system. Use of filters at the receiving point allows selective separation of all these signals even though transmitted from a single sending point.

Very recently DuMont engineers have been testing photovision equipment over distances of several miles. Even with the not yet perfected equipment now available, promising results are being obtained with both video and audio signals. The remarkable thing is that the seemingly dull light spot on the transmitting cathode-ray tube can be picked up several miles away by suitable focusing means, despite bright sunshine, and translated into pictures and sound. Fog is still an obstacle, but further developments may largely circumvent such interference. Full-scale commercial equipment has been evolved in the past few weeks and will soon be demonstrated as photovision steps out of the laboratory and makes its bid for a place in everyday telecasting.

The highly directional characteristics of this communications medium, coupled with its privacy feature and reliability, makes it very probable that it will find many uses in other fields of communication, such as broadcast relaying and point-to-point telegraph or telephone.

SIMPLE PANEL MARKER

If you have one of the small rubber-stamp sets, it can be used to do a neat job of lettering on the panels of receivers, transmitters, and other apparatus. After setting up the type, attach a piece of cotton cloth to a block of wood and coat it with a light coat of white lead. Press the stamp lightly on the surface of the cloth to pick up a thin coating on the raised surfaces of the type. The stamp is then pressed lightly against the surface of the panel to transfer the lettering. Light pressure should be used to prevent smearing the letters. **EDWIN BOHR,**
Chattanooga, Tenn.

RADIO-CRAFT for JULY, 1947

3 WAYS TO BE AHEAD

in Buying Test Equipment



Model 599-A Tube and Set Tester

SPECIFICATIONS
DC Volts — 5 ranges 0/6/15/150/600/1500 volts, 1000 ohms Per volt.
AC Volts — 3 ranges 0/15/150/600 volts.
DC Current — 3 ranges 0/15/60/600 millamps.
Output Volts—0/15/150/600 volts
Ohmmeter — 4 ranges 0/200/20,000 ohms and 0/2/20 megohms.

Condenser Checker—Ohmmeter provides fast method of checking leakage of both paper and electrolytic condensers.
Battery Tester — Tests most commonly used dry portable batteries of 1.5/4.5/6.0/45/90 volts. English reading "Replace-Good" scale.

Tube Tester — Circuit incorporates proven and modernized emission circuit. Checks for short, leakage, and noise tests between elements.
Power Supply—100-133 volts—50/60 cycles. Special voltages and frequencies on request.

1 BUY ACCURACY

2 BUY DEPENDABILITY

3 BUY SUPREMACY



SUPREME INSTRUMENTS CORP., Greenwood, Miss., U.S.A.

Export Department: THE AMERICAN STEEL EXPORT CO. Inc., 1347 Madison Ave., New York 17, N. Y., U.S.A.

TEL-RAD VALUE



DETROLA
Automatic Record Changer

Smooth, fast changing cycle — fool proof—plays 10" & 12" records. **\$14.79**

4" PM 1 oz. ALNICO MAGNET with mounting for output. **\$1.20**
6 for \$6.50 EACH

5" PM 1 oz. ALNICO MAGNET with mounting for output. **\$1.25**
6 for \$6.75 EACH

3 Tube PHONO AMPLIFIER Volume, tone controls, uses 35Z5, 12SQ7, 50L6, ALL WIRED. Less Tubes. **\$2.95**

2 Tube PHONO OSCILLATOR complete with tubes. Tune in on any Broadcast Set. ALL WIRED. **\$5.95**

A. 9" Phono Motor & Turntable Constant Speed. Famous Make. **\$3.00**
B. Crystal Pick Up Model L-70. **\$2.45**

90 Mil POWER TRANSFORMER. 110 volt Primary. 600 volts C.T., 6.3 volts, 5 volts. **\$2.95**

25% with Order. Balance C.O.D. Plus Postage.

TEL-RAD ELECTRONICS CO.

169 Washington St.
NEW YORK 6, NEW YORK

Do you need BINDING POSTS?



The XL PUSH POST with its Spring Action assures Constant Contact and Quick connection.
Manufactured in All Aluminum Type M at 12c each.
Aluminum Body, Bakelite Top Type S1 at 15c each.
Type CP or NP. ALL BRASS—STAINLESS STEEL SPRING & PIN. PROVEN BY 240 HR. SALT SPRAY TEST as NON-CORROSIVE at 28c each.
Manufacturers and Dealers Liberal Discounts

X. L. RADIO LABORATORIES
420 West Chicago Ave., Chicago 10, Ill.

New magnetic material, *supermalloy*, developed by Bell Telephone Labs, has 200 times the permeability of silicon steel.

BE YOUR OWN BOSS!

MAKE MORE MONEY



\$1.00 VALUE
25c

40,000 WORDS IN TEXT

NO ADS ALL "MEAT"!

In "CASH IN" you now get THE real money-makers — dozens of profitable tested mail order plans, confidential business secrets, dozens of practical tested formulas, successful tested schemes — actual experiences of men who have started on a shoe-string—with less than \$10 capital. 25c a copy postpaid. Send U. S. stamps, money order, or coin.

Money Back Guarantee

NATIONAL PLANS COMPANY
Box 26RA, Ansonia Station New York 23, N. Y.

EASY TO LEARN CODE

It is easy to learn or increase speed with an Instructograph Code Teacher. Affords the quickest and most practical method yet developed. For beginners or advanced students. Available tapes from beginner's alphabet to typical messages on all subjects. Speed range 5 to 40 WPM. Always ready—no QRMs.



ENDORSED BY THOUSANDS!

The Instructograph Code Teacher literally takes the place of an operator-instructor and enables anyone to learn and master code without further assistance. Thousands of successful operators have "acquired the code" with the Instructograph System. Write today for convenient rental and purchase plans.

INSTRUCTOGRAPH COMPANY

4701 Sheridan Rd., Dept. RC, Chicago 40, Ill.

FOR YOUR NEW Direct-Reading-Standing- WAVE METER

2" sq. 0-1 D.C.
Milliammeter
Blank Dial or as
Illustrated.



\$3.95
EACH

Bathtub capacitors .1 mfd.—.25 mfd.—5 mfd.—
8X.1 mfd & 1.0 mfd **14c**
400 & 600 Volts D.C.W. EACH
Mail orders filled. Send check or money order.
Postage Prepaid.

UNITED RADIO & SOUND AMPLIFICATION CO.

P.O. Box 2490 Phila. 48, Pa.

Don't forget
to refer to the

RADIONIC

Catalog!

BUILD 15 RADIOS

Absolutely No Knowledge of
Radio Necessary

You Need No Additional Parts or Tools

36-Page Book Written by Expert Radio Instructors . . . teaches you to Build Radios in a Professional Manner.

You will start with a 1-Tube Receiver—Before you are done with this Kit you will have built 11 Receivers, 1 Public Address System and 3 Transmitters.

The PROGRESSIVE RADIO KIT
is **THE ONLY COMPLETE KIT**—Contains
Everything You Need! Instruction
Book, Metal Chassis,
Tubes, Radio Parts, Soldering
Iron, Cutter Pliers and Screw-
driver.

PRICE
\$19.75

Special FREE OFFER for limited time
only. FREE Electrical and Radio Tester
with Each Progressive Radio Kit.

Progressive Electronics Co., Dept. RC-3
22 Havemeyer St., Brooklyn 11, N. Y.

Send me the Progressive Radio Kit.
 Check or Money Order Inclosed. Postage prepaid.
 C.O.D. I will pay postage.
 Send for further information.

NAME

ADDRESS

CITYZONE.....STATE.....
NO C.O.D. Outside U.S.A.

GUILLOTINE FOR FM

To radiomen, the "guillotine" means a new variable-inductance tuner developed by General Electric. For use in FM reception, it is considered more efficient than condenser-coil tuning.

The tuner consists of 2 identical silver-plated brass frames which, when connected at their open ends, form a 2-turn inductance. The inductance of the 2 turns is varied by insertion of a silver-plated brass "guillotine" blade between the turns. The effect of the blade is to reduce the inductance of each turn and also the mutual inductance between the turns. The tuning curve is adjusted by cutting slots in the blade which provide an easy and permanent means of tracking the oscillator and r.f. circuits with each other. Both terminals of the tuner project through the receiver chassis, making very short leads possible and providing a rugged tie point for soldered connections.

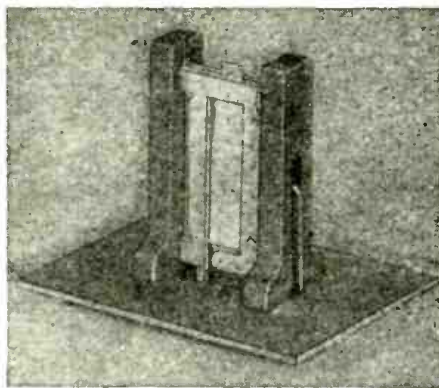

Electrical design problems in the front end are greatly simplified by the use of the guillotine tuner because it is possible to localize each tank circuit within a small area and to keep r.f. chassis currents at a minimum. Microphonic troubles are almost completely absent. The blade of the guillotine being ungrounded, sliding contacts and pig-tails are eliminated. All of these factors contribute toward an efficient electrical design providing high performance with little trouble from regeneration or alignment difficulty.

The tuner assembly is enclosed in a metal box for shielding and for mechanical protection and dust-proofing. Operation on the short-wave spread bands is comparable to communication receiver performance and ease of tuning. Short-wave microphonic howl, reports I. J. Kaar, manager of General Electric's Receiver Division at Bridgeport, Connecticut, is completely absent with the use of the guillotine tuner, making the full audio power output of the receiver usable on all bands. Loop reception is provided on all of the AM bands and power line pickup is used for local FM reception. Terminal connections are provided, of course, for AM antenna and FM dipole use wherever required.

It appears that this particular technique will be widely employed in the future for applications involving the upper frequencies, especially for FM and television.

HARD-TO-GET PARTS

POWERFUL ALL-PURPOSE INDUCTION MOTOR

IDEAL FOR EXPERIMENTERS—101 USES

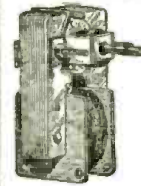

Sturdily constructed to precision standards, this self-starting shaded pole A.C. induction motor is powerful enough for a number of uses. Some of these are: Automatic Timing Devices, Current Interruptors, Electric Fans, Electric Chimes, Window Openers, Photocell Control Devices, Electric Vibrators, Small Grinders, Buffers and Polishers, Miniature Saws, Mechanical Models, Sirens, and other applications.

Consumes about 15 watts of power and has a speed of 3,000 r.p.m. When geared down, this sturdy unit will constantly operate an 18-inch turntable loaded with 200 lbs. dead weight. Dimensions 3" high by 2" wide by 1 1/2" deep has a convenient mounting stud; shaft is 3/16" long by 3/16" diameter, and runs in self-aligning oil-retaining bearings. Designed for 110-20 volts, 50-60 cycles A.C. only. Smp. Wt. 2 lbs.

ITEM NO. 118 YOUR PRICE **\$2.95**

ULTRA MAGNET

LIFTS MORE THAN 20 TIMES ITS OWN WEIGHT

LITTLE GIANT MAGNET

Lifts 5 lbs. easily. Weighs 4 oz. Made of ALNICO new high-magnetic steel. Complete with keeper. World's most powerful magnet ever made. The experimenter and hobbyist will find hundreds of excellent uses for this high quality permanent magnet. Measures 1 1/2" x 1 1/2" Ship. Wt. 3 1/2 lbs.

ITEM NO. 189 YOUR PRICE **\$1.50**



GENUINE MICROPHONE TRANSMITTERS



Regular telephone transmitters taken from a large telephone supply company's overstock. Work perfectly on 2 dry cells. Can be used on P.A. systems, call systems, inter-communications, etc. A short-line telephone circuit, house-to-house or farm-to-farm phone lines, also to talk through your own radio or as concealed telephone pickup. Useful replacements on battery-operated rural telephone lines.

THESE ARE GENUINE TRANSMITTERS, MADE BY KELLOGG, WESTERN ELECTRIC AND STROMBERG-CARLSON, excellent in appearance and operation. A remarkable value and one seldom offered in these times. Ship. Wt. 1 lb.

ITEM No. 180 YOUR PRICE **\$2.10**

AMAZING BLACK LIGHT!!

powerful 250-Watt Ultra-Violet Source



The best and most practical source of ultra-violet light for general experimental and entertainment use. Makes all fluorescent substances brilliantly luminescent. No transformers of any kind needed. Fits any standard lamp socket. Brings out beautiful fluorescent hues in various types of materials. Swell for amateur parties, plays, etc. to obtain unique lighting effects. Bulb only. Ship. Wt. 2 lbs.

ITEM NO. 87 YOUR PRICE **\$1.95**

WESTERN ELECTRIC BREAST MIKE

This is a fine light-weight aircraft carbon microphone. It weighs only 1 lb.

Mike comes with breastplate mounting and has 2-way swivel adjustment so that it can be adjusted to any desired position. There are 2 woven straps; one goes around neck, the other around chest. Straps can be snapped on and off quickly by an ingenious arrangement.

This excellent mike can be adapted for home broadcasting or private communication systems. By dismounting breastplate, it can be used as desk mike.

Comes complete with 6-foot cord and hard rubber plug, finished in aircraft-grade aluminum plate, non-rustable. Shipping weight, 2 lbs.

ITEM 152 YOUR PRICE **\$1.49**

WATT HOUR METER

Completely overhauled and ready for immediate service. Designed for regular 110-volt, 60 cycle 2-wire A.C. circuit. Simple to install. 2 wires from the line and 2 wires to the load. Sturdily constructed in heavy metal case, 6" high, 6 1/4" wide, 5" deep. Westinghouse, G. E. or Ft. Wayne, Sankams or other available make Smp. Wt. 14 lbs.

ITEM NO. 33 YOUR PRICE **\$6.95**

HUDSON SPECIALTIES CO.

40 West Broadway, Dept. RC-7.47, New York 7, N.Y.

I have circled below the numbers of the items I'm ordering. My full remittance (which includes shipping charges) is enclosed (NO C.O.D. ORDERS UNLESS ACCOMPANIED WITH A DEPOSIT.) Or my deposit of \$5.00 is enclosed (same required, ship order, C.O.D. or balance, NO C.O.D. ORDER FOR LESS THAN \$5.00. BE SURE TO INCLUDE SHIPPING CHARGES.) Circle Item No. wanted:

147 159 180 87 152 33

Name

Address

City State

"BRAND" VS. "ORPHAN" RADIOS

(Continued from page 17)

As long as the receiver plays it will sell to the unwary who cannot afford to pay for a standard brand. It stands to reason that such receivers will cost more in servicing and upkeep than reputable makes.

Unfortunately the public at large does not know all of this, because to most laymen a radio set is a radio set, no matter what its make, as long as they hear it play loudly in the store. Later on, when it refuses to perform and has to be serviced several times, the eventual brunt may fall on the unhappy serviceman who gets blamed for not being able to repair the set so that it will continue to work satisfactorily.

Sooner or later the public will come to understand that the set itself was no bargain. This completes the cycle where both the dealer and the serviceman get the ill will of the public. This situation is by no means new.

These same cycles have occurred repeatedly in this country and they will most likely continue for a long time under our free economy.

The radio industry itself is to be blamed in large part for this condition. To the best of our memory, the radio industry has never made a concerted effort to educate the public that it is cheaper in the end to buy a higher-priced known brand set than to buy unknown fly-by-night makes—the so-called "orphan" radio sets—of which there are many today.

If it is impossible—which it probably is at the present time—to reduce drastically the price of standard brands, it would seem the intelligent thing for the established radio set manufacturer to use newspaper and magazine publicity to prove to the public that it pays to buy well-known sets with a real guarantee behind them and educate the public to stay away from "distress" and "orphan" radios.

The serviceman, particularly, would be smart to refuse to service such unknown makes, which in the long run bring only grief and make no friends or money for him.

Once a serviceman tells a set owner that it is not good economics for him to invest service and repair money in a set that will only go to pieces later on, half the battle against this type of merchandise is won. The serviceman should furthermore protect himself by *stating in writing* to the set owner that such repairs should be considered only as of a temporary nature and that in all probability the particular receiver calls for endless and costly servicing. This protects the serviceman; it also demonstrates that the servicing industry is working in the public's interest rather than in its selfish own.

Such a strategy always commands the respect of the set owner because he is warned beforehand that he cannot expect orphan receivers to stand up and perform indefinitely.

VERIFIED SPEAKERS

"They Speak for Themselves"

DISTRIBUTORS enjoy selling them because they make friends and build business. The **VERIFIED GUARANTEE** back of the distributor enables him to immediately replace any defective speaker with a new one saving time and money for the **RADIO SERVICE MAN.**



LIVE BRILLIANT TONE

2233 UNIVERSITY AVENUE
WRIGHT, INC., St. Paul 4, Minnesota

ARMY-NAVY HEAD PHONES

\$2.49



B.A. made a lucky buy Genuine U. S. Signal Corps head phones, 8000 highly sensitive, 8000 ohms impedance. Only 2\$49 a pair plus 20c postage and pkg. chgs. Retail value \$13.50. Order No. 17A37

FREE Catalog

GET THIS catalog, latest developments in radio and electronic parts and devices, newest ham gear, gadgets and bargains.

BURSTEIN-APPLEBEE CO.,
1012 McGee St., Kansas City 6, Mo.
Send me your new FREE catalog.
Send me _____ pairs of phones at \$2.49 plus 20c pair postage. I enclose \$_____ in payment. RC

NAME _____
ADDRESS _____
TOWN _____ STATE _____

ELECTRICIANS! RADIOMEN!

Get this Valuable Book **FREE**

Tells How to Start Your Own Shop for Merely Examining Coyne's NEW Pay-Raising

3 VOLUME APPLIED PRACTICAL RADIO SET

Now!—a sensational new Practical set of radio books, just off the press, gives you the "know how" on everything in Radio today! Basic principles to newest television and FM—how to construct, install, service. 600 illustrations, nearly 1,000 pages. Ideal for home training or field reference—backed by Coyne's 48 years of shop experience, to help you to bigger radio opportunities! And here's our amazing offer: To prove the value of these great new books to you, Coyne will give you our new, practical "Business-Starting" book Free just for looking over the 3-volume set.

OFFER LIMITED—ACT NOW! Just mail the coupon below. We'll send you the 3-volume APPLIED PRACTICAL RADIO set for 7 days' free examination and include our 240-page book "Starting & Operating a Profitable Radio or Electrical Business". Look the set over for 7 days. If you like it, then pay its low cost on easy terms as shown in coupon below. If you don't want the set, just return it and owe NOTHING!

FREE BOOK COUPON Either way, you keep the "Business-Starting" Book **ABSOLUTELY FREE.** Send no money. Coupon below is just a request to see the new set and receive your free gift book. Mail coupon today.

DEBAUGH COMPANY, DEPT. RC
400 Allegheny Avenue Towson 4, Maryland

NAME _____ AGE _____
ADDRESS _____
CITY _____ Zone _____ STATE _____

A.C. CURRENT ANYWHERE!

With
Katligh Plants and Generators

Furnish the same kind of Current as the highlines. Sizes 500 watts to 100 KW. Also Manufacturers of Rotary Converters, Frequency Converters, 32 and 110 Volt D.C. Motors in 1/2, 1 3/4 and 1/2 H.P. A.C. Motors, single phase in 1 1/2 and 2 H.P. only.

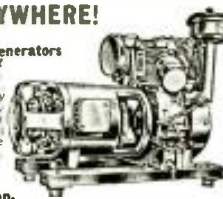

KATOLIGHT
120 Rock St., Mankato, Minn.

MINIATURE TEST OSCILLATOR

Pocket size 1 3/4" round 5" long. Very convenient for servicing and aligning RF and AUDIO circuits. Supplies 60 cycle modulated RF; 100 to 200 KC on fundamentals and continuous coverage for IF. Broadcast and Short Wave bands on harmonics. 6S37 tube electron coupled for stability. 115 V. AC operated. \$7.85 postpaid or send \$1.00 and pay \$6.95 C.O.D. You must be satisfied or your money cheerfully refunded.

DEBAUGH COMPANY, DEPT. RC
400 Allegheny Avenue Towson 4, Maryland

Radar, already important at sea and in the air, is to be used on land as an aid to highway safety, Connecticut State Police report.

A microwave signal sent out by the

radar is reflected by the moving car, Doppler effect causing a wavelength shift which increases with the car's speed. This shift is translated into miles per hour on the instrument's meter.

S.S.S.

"Servicing by Signal Substitution"

Learn about this modern dynamic approach to radio servicing with ONLY BASIC TEST EQUIPMENT.

... Fully described in a 120 page book available from your Precision Distributor or factory of 35¢.

... Schools are invited to inquire regarding quantity orders from our Educational Division.

PRECISION APPARATUS COMPANY INC.
ELMHURST 4, N. Y.

Manufacturers of Fine Test Equipment
RADIO • TELEVISION • ELECTRICAL • LABORATORY

ELECTRONIC

VOLT-OHMMETER

\$11.85

110 VOLTS AC 20 RANGES

0/5/10/50/100/500/1000/5000 volts DC and AC. 0-1,000,000.000 ohms in six overlapping ranges. Sensitivity; over MILLION OHMS per VOLT on 5 volt range.

POSTPAID

Complete kit includes all component parts, tubes, punched and drilled chassis and beautifully enameled panel. Easily assembled and wired.

Special slideback circuit developed during war by scientists at the California Institute of Technology gives amazing sensitivity and flexibility while completely eliminating necessity of batteries and expensive meter. Each instrument is individually calibrated. Dial scale over nine inches long!

In addition to performing the usual volt-ohm functions, this instrument easily measures these voltages: SUPPLIER OSCILLATOR, AVC, AFC, TRUE GRID BIAS AT THE GRID, BIAS CIRCLES without affecting the circuit. Measures the exact leakage resistance of INSULATION, TUBES, CONDENSERS. It can be used with a signal generator for SIGNAL TRACING.

STERLING ELECTRONIC COMPANY
166 N. Sierra Bonita Ave., Dept. 2, Pasadena 4, Calif.

FMT ★ FM Tuner Permeability Type

A complete fully assembled, tested oscillator-mixer that tunes in the 88 to 108 MC FM broadcasts. Enjoy noise free high fidelity radio reception. FMT output feeds into usual FM I.F. amplifier which you can easily build, or into the older FM-45 receivers (I.F.) to change them to the new FM band. All parts, including a standard metal tube, are combined into a single compact unit measuring only 2 3/4" x 1 1/2" on chassis, to which you connect aerial wire and three voltage wires. It works right every time. It will save you headaches and lots of work, as compared with trying to make a VHF oscillator-mixer with usual clumsy parts available. The FMT is calibrated to feed into 10.7 MC and other I.F. Introductory Price \$6.50 (less tube) postpaid. State I.F. used. Complete directions and drawing with each unit.

Est. 1922 **J-M-P Mfg. Co.**
ORDER TODAY FMT Dept., Milwaukee 10, Wis.

NEWS ABOUT

THE LATEST IN RADIO PARTS—EQUIPMENT—ELECTRICAL DEVICES—brought to you in our monthly bulletins. **ABSOLUTELY FREE!** No obligation.

WRITE TO
MANUFACTURING DIVISION
HERBACH & RADEMAN, INC.
ELECTRONICS SPECIALISTS
522 MARKET ST., PHILA. 6, PA. • DEPT. B

Don't forget to refer to the

RADIONIC

Catalog!

NARROW-BAND FM FOR HAM RADIOS

(Continued from page 23)

The circuit of Fig. 6 can be readily switched from AM to FM. It requires a little more digging into the receiver than some of the other arrangements described. However, it makes it possible to employ the existing transformer in most communications receivers. A 3-pole, double-throw switch is required. Both ends of the secondary are switched from the AM diode detector to the crystal diodes as FM detector. The third switch connection switches the audio from the existing detector to the discriminator output. Remember that at

maximum deflection of the center-frequency indicator. Then retune the secondary for zero (center indication of the meter). When properly tuned, signals an equal frequency difference away from the center frequency should give the same reading on opposite sides of the zero on the indicator.

A special adaption

A means of utilizing the double ended (push pull) detector of an RME 69 receiver is described in Fig. 8. A 3-pole double throw switch may be employed to switch the ends and center tap of the detector transformer. The materials required in addition to the switch are a 50- μ mf mica capacitor, "E" connected from last i.f. plate (6D6) to the r.f. choke of the discriminator at "B." Also required are the crystal elements and the necessary resistors and condensers comprising the discriminator circuit. A center frequency indicator is shown in this arrangement. The audio output connection from the discriminator goes directly to the audio input because when the discriminator is unconnected to the transformer it will be inoperative.

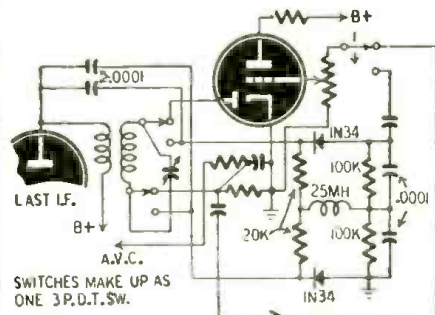

Fig. 6—Practical circuit for standard coils.

taching the components of these circuits to your set will detune the i.f. transformer to which they are connected. Realignment of the last stage will be necessary! The circuit of Fig. 6 for a single-ended transformer can be applied as in Figs. 2, 3, and 4.

Possibly the best way to make the additions for narrow-band FM reception will be to build a separate unit as is shown in Fig. 2 and connect as in Fig. 3. In using these adapters it is also wise to remember that the wide-band position of the receiver selectivity control gives best reception.

Any one of the arrangements can have a center-frequency indicator as described above. The connection is the same as for Fig. 2. It is essentially a high-impedance d.c. voltmeter.

The discriminator can be aligned very simply. Connect the signal generator to the last i.f. stage and adjust frequency to the exact center of the intermediate frequency. With the discriminator secondary detuned somewhat, adjust the primary for

Alignment of the RME 69 will be required after the adjustment. It is important that the switch be placed as close as possible to the detector i.f. transformer so that leads will be short. The center-frequency meter will have to be an external device. The parts indicated in the diagram by numbers as C15, R17, etc., are the designations of the RME 69 service schematic.

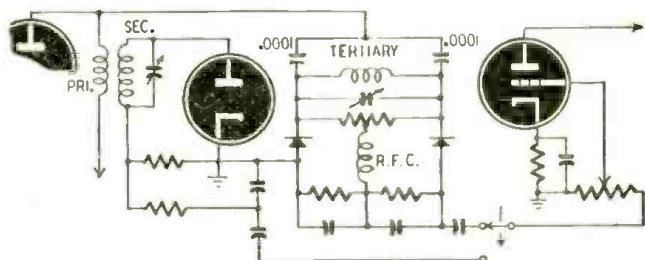

Fig. 7—If transformer has 3 windings, this circuit can be used.

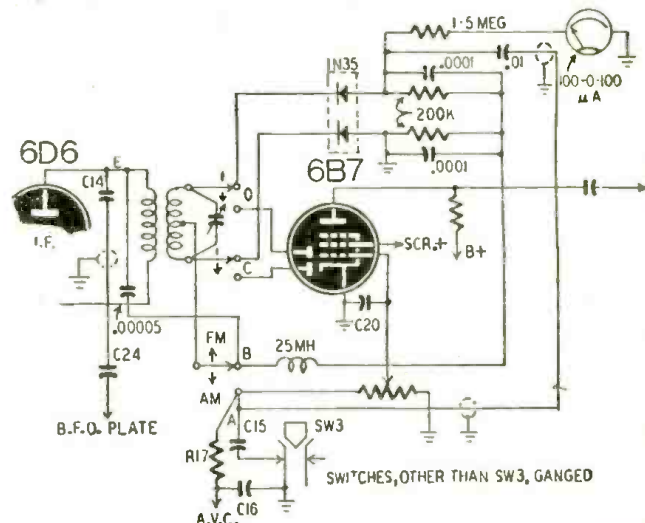

Fig. 8—How an RME 69 can be made an AM-narrow-band FM receiver.



Dial Belt Kit Ne-O-Lite Tester Inspection Lite - Chemical Lab.

**G-C
ELECTRONIC
CHEMICAL
LABORATORY**



G-C INSPECTION LITE

Ideal for servicing. Lights up hard-to-see corners. Perfect for repairmen, experimenters, etc. 110-20 AC-DC. No. 705—Dealers Net 90c



Ideal for all servicemen. 19 bottles and chemicals in heavy (free) steel rack. No. 998—Dealers Net \$6.67

G-C NE-O-LITE TESTER

Handy, inexpensive; a tester that everyone needs for countless uses. Can be used on 60 V.A.C. to 500 V.A.C. or D.C. No. 5100—single tester on card—Dealers Net 30c



G-C SERVICEMEN'S DIAL BELT KITS



Fine woven replacements for all sets. Easy to install. Supplied with steel box in kits. No. C-25. Kit of Dealers Net \$4.02

Sold by All Jobbers
Write for complete catalog today!

RADIO DIVISION DEPT. D

GENERALCEMENT Mfg. Co., Rockford, Ill., U.S.A.
Manufacturers of over 3,000 products
Sales offices in principal cities

ANTENNA PRINCIPLES (Continued from page 39)

at A in Fig. 2 will be directive primarily in the horizontal plane of the field.

An important variation of the sectoral horn is known as the *pyramidal horn* which is flared in *two* dimensions. This horn can be designed to provide an equidirectional pattern in all planes of radiation.

A *conical horn* (B in Fig. 2) provides a similar equidirectional field pattern.

Width of the horn mouth should be at least ten times the wave length. The distance from throat to mouth should be approximately the same. The amount of flare, or flare angle, will have marked effect on the directivity pattern. But, again, exact design data is complicated because of the various modes involved.

Conical horns are ordinarily used with circular wave guides. Field patterns are equally directional in both horizontal and vertical planes.

NEW RADIO ELECTRONIC PATENTS

(Continued from page 48)

every third cycle to be applied effectively.

The fundamental frequency is applied in the plate circuit of a triode (from "sine wave source" in the accompanying diagram). The triode is hooked up in a Hartley circuit tuned to the frequency of the desired sub-harmonic.

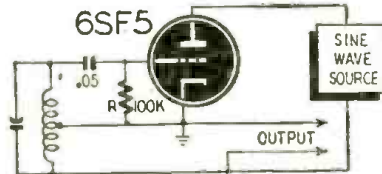

During the first positive half-cycle of source frequency the tube conducts and the circuit oscillates. A positive pulse is applied at the grid as a result, and current flows in the grid circuit. In flowing through the resistor, the current biases the grid past cut-off so that (temporarily) the fundamental frequency has no further effect. However, oscillations can continue in the resonant circuit at the sub-harmonic frequency to which it is tuned. Maximum output is obtained by adjusting R and C so that the grid charge leaks off just in time to permit every *n*th cycle of the fundamental frequency to start oscillations, where *n* is the order of the sub-harmonic desired. In the figure the source is tuned to 10,000 cycles and the Hartley circuit (and therefore the output) to 1,000 cycles. Constants given are correct to produce the desired effect.

TRANSATLANTIC NEWS

(Continued from page 40)

towers were modified to increase their height to 800 feet, and an antenna was erected consisting of 2 triatics with the apex of each supported by a cable anchored to the mountaintop.

The capacitance of the antenna proved to be about 24,000 μf ; its resistance and that of the ground total 0.5 ohm. The antenna tuning inductor has a diameter of 15 feet 9 inches. It is wound with litzendraht cable containing 6,561 strands and having an over-all diameter of 1.5 inches. At 16 kc the inductance of the coil is 5.36 millihenries and its h.f. resistance 0.14 ohm. The Q is thus 3,850!

FLASH!

**NOW AVAILABLE FOR
THE FIRST TIME!**

BASIC

TRANSVISION

TELEVISION PARTS

CHASSIS—Cadmium plated (complete with bottom plate). Punched with over 200 holes. Saves you money and hours of tiresome work **\$12.75**

I.F. TRANSFORMERS—3.5 megacycle band width—Set of five (4 video; 1 12.50 sound) per set of 5

R.F. UNIT—Wired and tuned for 3 stations **26.95 ea.**

HIGH VOLTAGE TELEVISION TRANSFORMERS—2500 v with 5000 v insulation and 2.5 v winding **9.55 ea.**

LOW VOLTAGE TELEVISION TRANSFORMERS—Primary—115 v; Secondary #1—725 v, 175 ma.; Secondary #2—5 v—3 a; Secondary #3—6.3 v—1.5 a **14.60 ea.**

TRANSVISION CABINET—Designed to accommodate Transvision Chassis. Beautiful, hand-rubbed, walnut finish. **29.95 ea.**
Top Grade

Manufacturer's Guarantee. Immediate Delivery. Send 10% with order (check or money order). Balance C.O.D. F.D.B. New York.

BEACON TELEVISION, INC.

143 E. 49th Street

New York 17, N. Y.

TUBES

ALL TYPES IN STOCK

**STANDARD BRANDS—R. C. A.
SYLVANIA, G. E. ETC.**

Minimum Order—10 Tubes

10 to 25—40% off List
26 to 100—50% off List
101 to 500—50 & 10 off List
501 and over—60% off List

OUR SPECIALS

CORNELL - DUBILIER - CONDENSERS

20 x 20—150V	.45
185—174—384—1R5	.69
25Y3—same as 25Z5	.59
6AH6—same as 6AK5	.69
6AK5—Brand New Western Electric	.89
Acorn Tubes 954-955-956-957	.49
Hearing Aid Tubes 501AX to 509AX	.49
All American Kit 50L6-35Z5-12SAT-12SK7-12SQ7	2.65
Miniature Kit 50B5-35W4-12BE6-12BD6-12AT6	2.65

OUR OWN BRAND "COMMERCIAL" TUBE GUARANTEED UNCONDITIONALLY—100%

All Types in Stock 60% off List
MADE BY STANDARD BRAND MANUFACTURER

Write for Catalog



COMMERCIAL RADIO

36 BRATTLE ST., BOSTON 8, MASS.

Department N

100 Assorted CONDENSERS
10 Assorted KNOBS
10 Assorted SOCKETS
100 Assorted RESISTORS
20 Assorted VOL. CONTROLS

ALL FOR

\$20.80

PHONOGRAPH AMPLIFIER \$9.45

Complete with Motor, Pick-up Arm, Speaker and Three Tubes

BROOKS RADIO DIST. CORP.

(Dept. A) 80 Vesey Street, New York 7, N. Y.

LAKE DELUXE CHANGER

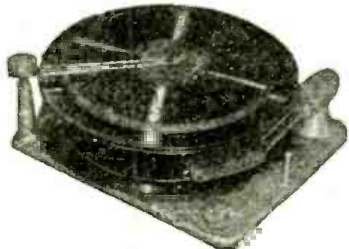

**Revolutionizes the Industry!
A SENSATIONAL SELLER!**

11 OUTSTANDING FEATURES:

- Positive Intermix
- Service Adjustments Eliminated
- Minimizes Record Wear
- Single Knob Control
- Picks-up arm may be grasped at any time and changer will not be thrown out of adjustment
- Resonance-free ball bearing tone arm
- Easily operated—any child can do it
- Plays ALL Records
- Completely Jam-proof
- Records Gently Lowered on Spindle—not dropped
- Automatic Shut-off on last record

Dimensions: 13 13/16" W x 12 1/4" D x 7 3/4" H No. 118A4 **YOUR NET \$2873**

SERVICEMEN—RETAILERS

Join our customer list today. Write today for our new 16-page illustrated catalog NR-116. It's free. Get on our mailing list. Dept. C

LAKE RADIO SALES CO.

615 W. Randolph Street, Chicago 6, Ill.

RADIO MEN

Write for Bargain
Catalog of Radio Parts
BUYERS' SYNDICATE

786 Carew St.

Springfield, Mass.

QUIK-LABELS CODE CARD SYSTEM

Removable Self-Starter Strip exposes ends of Labels for you to peel!

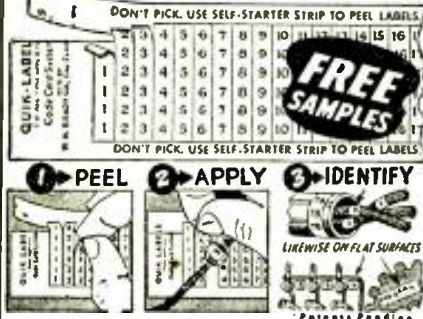

QUIK-LABELS Make Money for YOU

QUIK-LABELS mark Wires, Circuits, Leads, etc. faster and cheaper. • Precut to exact size, QUIK-LABELS come in rows on handy cards, stick without moistening. • Replace slow and costly string tags, metal tabs, etc. • Marking wires at time of disassembly speeds up reassembly, helps you make many MORE REPAIRS IN A DAY. • Also brings you a better price for your work when customers see you have marked and reconnected wires just like at the factory. • These handy labels fit in pocket or tool kit. • 500 different radio & electronic symbols in stock. • Send us this ad attached to your letterhead for Folder and FREE Sample Cards.

W. H. BRADY COMPANY

Identification Specialists

Established 1914

802 N. Third Street, Milwaukee 3, Wisconsin

SPECIALS!

Here is an opportunity for you to save up to 50% on popular replacement items you'll use every day. Top quality brands. Orders below shipped postpaid in U.S.A.

- 8mfd. 475v. tubular electrolytic condensers. Twelve for \$5.00 postpaid.
- 20-20mfd. 150v. tubular electrolytic condensers. Eight for \$5.00 postpaid.
- Kit of 25 tubular paper condensers in assorted capacities. Per kit \$2.00 postpaid.
- Oscillator coils for 12-A7, etc. 450kc. I.F. Three for \$1.00 postpaid.

EATON'S Box 471-C Logan, Utah

LEARN

ELECTRICITY OR RADIO

... in the
GREAT SHOPS OF COYNE
Train in a Few Short Weeks

Here at Coyne in a few short weeks you can train for your big opportunity in Electricity or Radio. You train on actual full-size Electrical or Radio equipment. 48 years training experience. For Veterans and non-veterans.

NOT A "HOME-STUDY" COURSE

All Coyne training is given here in our big Chicago shops. Not a Correspondence course. VETERANSI Coyne is authorized to train Veterans under the G.I. Bill. Coupon brings details.

FREE BOOK—Two great opportunity fields—rush coupon for free illustrated book on whichever course you prefer—no obligation. Tells how Coyne helps you get better jobs.

Your Choice of 2 Great Fields

B. W. COOKE, Dir.,
COYNE ELECTRICAL
SCHOOL, Dept. B7-784
500 S. Paulina St., Chicago 12, Ill.

Send FREE BOOK and full details on course checked:

ELECTRICITY RADIO

NAME.....

ADDRESS.....

CITY..... STATE.....

FRENCH RADIO-MODEL AUTO

(Continued from page 21)

L3—Same as L2.

In the transmitter which sends waves of varying frequencies, condenser C is replaced by one of the condensers in the control box of Fig. 3.

The modulator furnishes an audio-frequency voltage capable of modulating the transmitter. Construction of this part is straightforward. Fig. 2 is a diagram of a simple unit for this purpose. In effect, the first tube, a 6C5, is an audio-frequency oscillator; the other tubes amplify its signal. The oscillator coil may be a Class B audio transformer with one center-tapped winding. The condenser across the tapped winding is selected to give a desirable note. The grid resistor may be varied also, for the same purpose. Any convenient power supply may be used.

The transmitting antenna may be of any type, but it is desirable that the maximum energy be radiated. An excellent solution is to use a horizontal half-wave antenna of the center-fed type. A quarter-wave vertical antenna, fed at the base, also might be used. In that case, it is necessary to add a capacitor in series with the antenna, tuning it so the maximum current is at the base, and therefore the maximum voltage is at the summit of the antenna.

Two possible procedures

In the first method, the control signals are produced by impulses; the modu-

lated r.f. wave exists only during short intervals, several milliseconds, for example, the extent of the impulsion depending on the control signal. The key, or, better, automatic telephone dial apparatus, permits obtaining different durations of signal. The key or dial is then connected at X in Fig. 1.

In the second case, control depends on the wave length. For example, the "left" control is transmitted on a frequency F1, the "right" control on a frequency F2.

Fig. 3 shows the apparatus adopted

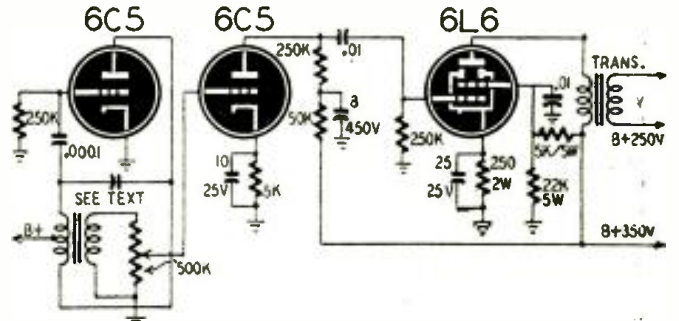

Fig. 2—Any convenient modulator circuit may be substituted for this.

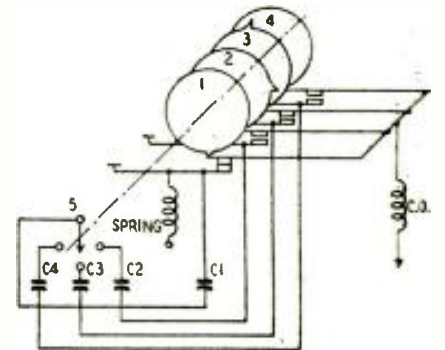
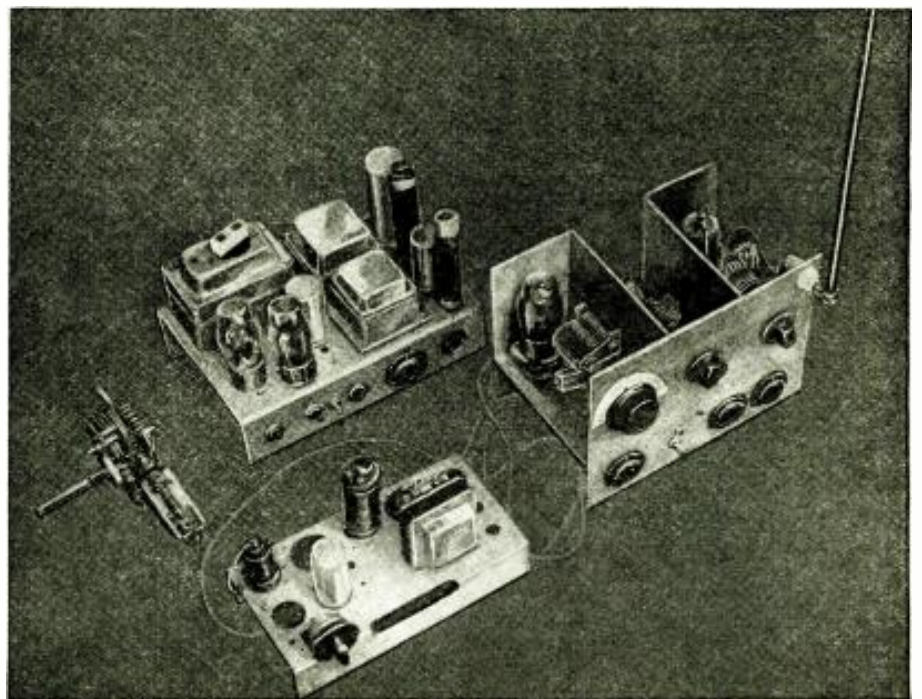

Fig. 3—Tuner for variable-frequency control.



Fixed station includes control, modulator, power pack and the 2-tube transmitter proper.

RADIO-CRAFT for JULY, 1947

by M. Roveyaz: four cams are fixed on a shaft connected to a motor, one for each control wave length. The motor shaft carries a selector S. Each key has a dog corresponding to one of the selector positions and placing a capacitor across the oscillating circuit CO. Which ever capacitor is switched in then will be condenser C of Fig. 1.

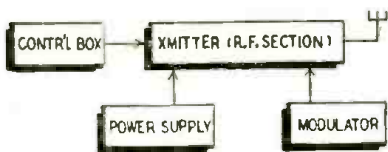

Fig. 4—Line-up of transmitting equipment.

The control apparatus includes several buttons, pressing one of which is sufficient to obtain a carrier frequency corresponding to the signal required to effect a desired maneuver.

Fig. 4 is a block diagram of the transmitter used when control is effected by changing frequency—the method with which we have experimented. However, both methods have been tried successfully by M. Roveyaz.

The receiving equipment

The automobile equipment consists first of an antenna to collect the waves emitted by the transmitter; the best solution seems to be a vertical aerial. This may be a demountable whip antenna, in the form of an aluminum or brass tube, fixed on the left side of the automobile.

The receiver preferably should be of the superregenerative type, permitting reception with a minimum of tubes. The detector may be a 955 or a 6J5.

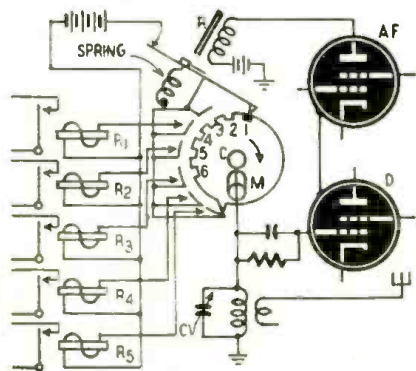

Fig. 5—Receiver, showing relay connections.

Fig. 5 gives a rough plan of the receiver used when the frequency-change control system was employed.

The cam C is coupled to the variable condenser CV by an insulating coupling, the ensemble being turned by the automobile's motor through a suitable step-down gear system.

If a carrier is transmitted, when the condenser CV in its rotation arrives at a point where its value is such as to tune its circuit to resonance to the transmitted frequency, a current is set up in the detector plate circuit. Amplified by a second tube, it causes relay R to close. This stops the cam as long as the signal continues. One of the relay circuits (R1, R2, R3, R4, R5) is closed and acts directly on its associated control.

If the frequency F1 stops, the relay opens and the cam again begins to turn with the variable condenser. A transmission on a new frequency F2 will again immobilize the cam in a new position corresponding to another "command."

Dry batteries supply power to the receiver's plates and the filaments are lit by small storage cells. In a full-sized automobile, the power could be supplied by the car's storage battery and a vibrator pack.

The mechanical controls are among the most delicate parts of the equipment. One arrangement, described in the magazine QST (March, 1940) includes a relay E supplied with current from a battery. Its armature A carries a hook at one end and a spring at the other. A cross which is coupled to a motor so that it turns on an axle when released ... (see Fig. 6) has a spur on

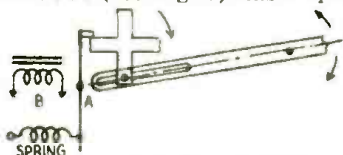

Fig. 6—One method of mechanical control.

one arm which passes through a slot in a lever which can control the steering gear or the speed governor of the model. The current passes through the electromagnet when its associated relay (R1, R2, etc., of the receiver) closes, the armature is drawn toward it, liberating the cross which moves a quarter turn, placing the lever in a new position.

This system moves by jerks. It is preferable to use electric motors, working on 2 to 4 volts and reversible by reversing their polarity; the shaft would be in the form of a worm gear into which a spur gear would fit. This would give a smoother control of direction.

Editor's note

The advanced radio experimenter will have little trouble with the construction of suitable sending and receiving equipment, which may differ widely in circuit design from that described here. However, he may find a recent American receiver circuit interesting. This, using the Raytheon RK-61 thyratron tube, is shown in Fig. 7. For greater ranges, it

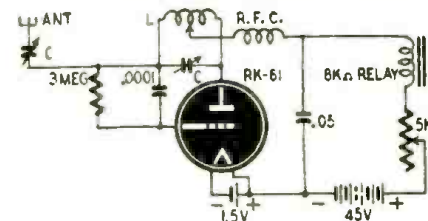

Fig. 7—Circuit of the RK-61 receiver. This is a sub-miniature thyratron, manufactured by Raytheon, operating with a B-battery of 45 volts; filament uses .05 ampere at 1.4 volts.

of course may be used as the second tube of a 2-tube receiver, and can be coupled readily to a superregenerative detector by any convenient means, such as an ordinary audio-frequency transformer.

Translated from the French, by special arrangement with the magazine La T.S.F. Pour Tous (Paris)

TEACH YOURSELF Radio & Electronics



Magi-Klips KIT

Build 18 Experiments at Home—No Tools!

RADIO RECEIVER, HOME BROADCASTER, PHOTOELECTRIC RELAY, CODE PRACTICE OSCILLATOR, SIGNAL TRACER, REMOTE CONTROL RELAY, Phonograph Transmitter, Intercommunication Amplifier, Code Transmitter, Radio Frequency Oscillator, Telephone Line Amplifier, Electronic Switch, Phonograph Amplifier, Temperature Control Relay, Contact Detector, Electronic Metronome, Interval Timer (one-shot), Interval Timer (repeating).

With a Magi-Klips kit you cover the entire field of radio and electronic engineering theory quickly in your spare time. It's simple to arrange the components for each circuit. No soldering. No tedious wiring. Kit operates on 110 v. AC or DC and includes 3525 rectifier, 501A power amplifier, 12SL7, double triode, powerful 4" speaker-miko, plate relay, broadcast and SW coils, tuning condenser and generous supply of resistors, condensers, chokes, extra wire. Parts worth double the price of kit.

Kit's 48-page manual has complete instructions and diagrams easily followed by the beginner. Remember, you need no tools, except possibly a screwdriver, with a Magi-Klips electronic \$29.75 and radio experimenter's kit complete

SCHOOLS—Magi-Klips KITS are excellent equipment for laboratory and classroom. Write for special discount.

DEALERS—Some territories open. Write for your trade discount.

DEER & TAYLOR COMPANY
Dept. C, 1340 Milvia St.
Berkeley 9, Calif.

Please ship Magi-Klips electronic kit (6).
I enclose \$
 Please mail illustrated folder on the Magi-Klips kit.

Name
Street
City State

ATTENTION Amateurs-Experimenters-Inventors

Cut your cost on radio supplies and equipment in half. Clip coupon today. Hundreds of "hard to get" war surplus items along with the best in standard brand equipment—all at great savings to you. Let us know your particular requirements. IMMEDIATE DELIVERY.

SEND THIS COUPON TO

NIAGARA RADIO SUPPLY CORP.
Dept. RC-7

160 Greenwich St.,
New York 6, N. Y.

Name
Address
City State
Call. No:

MILES "TELEMIKE"

A midjet unit (1 1/4"x1 1/4"x1 1/4") requiring no physical contact to telephone. PICKS UP BOTH SIDES OF TELEPHONE CONVERSATIONS for group loud speaker listening or for recording when used with standard amplifier or recorder. PRICE \$25.00 postpaid. Write for details on our complete line of PHONOGRAPH TELEPHONE—CONFERENCE—DICTATION—"TALKIE" RECORDERS & REPRODUCERS.

MILES REPRODUCER CO., Inc.
Dept. RC-7, 812 Broadway, New York 3, New York.

Don't forget to refer to the

RADIONIC

Catalog!

Communications

PROGRESS DUE TO EXPERIMENTERS ONLY

Dear Editor:

Here is one who takes your predictions and opinions with several pounds of salt before digesting.

Where are all the great improvements, where are the innovations, the better radios, and the urge of the public to buy these millions of radios you predicted?

The great hoop-la of the coming radio has died down. The only advance in Radio has been in the price, as I thought all along and still think. And this is the only logical way to think. The radio makers are interested in profits, not radio, and will be to the end of time, and the 5 to 8 tube superheterodyne fits the bill very nicely.

The only dynamic work left in the Radio reception field is the regenerative circuit, which in my opinion has been but half explored. T.r.f.'s with regeneration—fixed crystals with regeneration—have hardly been touched.

In closing I can only say the public will get no advances in Radio unless it means more profit for the makers, like FM, etc.

All advances are known and shared only by a small coterie of home construction experimenters and hams. And even

these are placed in a disadvantage. The manufacturers refuse to make ready-made coils of the plug-in or switch type any more. Anyone with the factory equipment capable of turning out coils for construction would clean up.

H. L. LUCE
(No Address)

(Few manufacturers would quarrel with Mr. Luce's assumption that they are in business for the money to be made in it; not because they are interested in radio. While there is a tremendous market for small, easily constructed receivers, it would be naive to expect the manufacturer to refrain from making them.

When the customer is sated with a.c.-d.c. "All-American" midgets and wants something better, the manufacturer will be able to make such sets more profitably than the cheaper ones, and there will be no shortage of them on the market. The same goes for plug-in coils. At present the coil companies are working at full capacity supplying coils for the new receivers. As soon as it becomes profitable to wind coils for the much smaller experimenters' market, they will become available.—Editor)

R-C HEADS 15-MAGAZINE LIST

Dear Editor:

Just received the December number, which is an anniversary number for me, as it is exactly ten years since I bought my first copy of RADIO-CRAFT (Short Wave Craft one year earlier). I should like to congratulate you on the amazingly high standard your magazine has maintained over the period. Yours is the only magazine I have purchased without a break for ten years (except of course the copies I lost to the U-boats). I now look forward to the next ten years!

One small brickbat. Could you hurry up the dispatch of RADIO-CRAFT? The December copy issued on the 25th of November arrived here on the 20th of February. Three months is a very long time. Most of the other magazines from the U.S.A. arrive the same month and are never more than a month late.

In closing I should like to state I subscribe to 15 British and U.S. radio magazines, with yours right at the top.

A. W. J. MARSH,
Isle of Wight, England

RADIO TERM ILLUSTRATED



Saturation Point

Suggested by:
Wm. F. Wendt,
Napa, Calif.

RADIO-CRAFT for JULY, 1947

The HOUSE OF A MILLION RADIO PARTS

SPECIAL DEALS for RADIO DEALERS and SERVICEMEN

Kit No. 85—Heavy Duty Rfm Drive
Motor and Turntable.....List \$ 9.95
Crystal Pickup.....List 6.50
Waterfall Walnut Open Case.....List 4.95
Meg. Vol. Control with Switch.....List 1.50
Six-foot AC Cord.....List .40
Kit Total List.....\$23.30

Your Cost only\$11.85

Kit No. 87—3 Tube Amplifier Kit complete with tubes and instructions—simple to build \$3.73
Kit No. 88—Above amplifier completely wired 8.70
Kit No. 89—5 inch P. M. speaker 1.95
Thousands of radio and sound equipment parts and supplies: Tubes, record changers, amplifiers, speakers, etc. Write for Catalog No. 31

Lifetime SOUND EQUIPMENT CO.
911-913 Jefferson Ave., TOLEDO 2, OHIO

RANGEMASTER

MODEL 10
BY BRADSHAW
A COMPLETE SERVICE INSTRUMENT



The model 10 RANGEMASTER covers 22 ranges. Three direct reading capacity ranges. Three A.C. current ranges for checking current drain of electric motors and appliances.

All in One Rugged, Compact, Attractive Unit

COVERS THESE RANGES

A.C. VOLTAGE: 1-10-100-500-1000 Volts
D.C. VOLTAGE: 10-100-500-1000 Volts
A.C. CURRENT: .05-.15 .5-1.5 5-15 Amperes
D.C. CURRENT: 1-10-100-1,000 Milliamperes
RESISTANCE: RX10 RX100 RX1,000 Ohms
CAPACITANCE: .001-.1 .01-1 .1-10 Mfd.

Available in Kit Form \$16.95
Factory Assembled \$23.50
Test Leads85
Electronic Components Available

SEND FOR DESCRIPTIVE LITERATURE
BRADSHAW INSTRUMENTS CO.
942 Kings Highway, Brooklyn 23, New York

RADIO KITS ARE TOPS FOR FUN AND ACCOMPLISHMENT

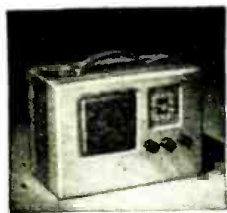

Build this portable radio Model 210... a three-way portable receiver, operating on either AC or DC or self-contained batteries—power switch conveniently located on front of set so that "Battery" or "AC-DC" may be selected without opening case. Five-inch Alnico 5 permanent magnet dynamic speaker, and case covered with weather-tested aircraft material. Accompanied by simple, detailed instruction sheet.

Available at your local distributor. If not, write to us.

Many other models available. Write for Catalog M

RADIO KITS COMPANY
120 Cedar Street, New York 6, N. Y.

The FCC has revised and reissued its primer. The ABC of the FCC, a nine-page booklet first published in 1940. The object and nature of FCC regulation; origin and set-up of the Commission; broadcast-application procedures; assignment of call letters, and other FCC activities are explained in it in simple question-and-answer form.

"THE CUSTOMER WILL GYP YOU . . ."

Dear Editor:

I have never written to any publication before, but now I feel I must. My reason: the disparaging remarks that are circulating among the layman in regard to the honesty of the radio serviceman. Personally I am not a serviceman; but I have spent six years of my life as a communications technician, two of those years as a radar technician for Uncle Sam's Army, and the rest in the fascinating hobby of amateur radio.

The other day I met an old friend and his buddies. My friend seemed peeved at something, and on inquiring I found that his dislike for the radio serviceman was immense. It seems that his Philco was in bad shape and he had taken the mess (and I do mean MESS) in for repairs at his local radio store. The estimate ran to about \$21.60. He tried several other radio shops and received approximately the same estimate. Of course the radio serviceman was an out-and-out crook, screw-driver mechanic, and an assortment of other choice cuss words!

For your benefit I shall list the cause of his complaint:

One open r.f. coil (replaced)
Dial drive cable and pointer (installed)

One noisy volume control (replaced)
Multisection electrolytic filter unit (replaced)

One power tube (replaced)
Re-center voice coil and alignment.

After my examination of his Philco, I wondered why the serviceman had not doubled his previous price. I feel that the price of \$21.60 was quite fair. How do you feel about it? How did that radio get into that condition?

I've traveled a great deal about this country and from my own experience in speaking with the average layman, they have the same thing to say about the radio serviceman—with a few exceptions. Can anything be done to remedy this appalling situation? It seems that the layman judges the service fraternity not only by the unscrupulous few that exist, but by his own wishful and uninformed thinking as to how much a repair should cost.

PHILIP SPAMINATO,
New York, N. Y.

"COILS, CORES, MAGNETS"

Dear Editor:

I certainly appreciate reading articles such as "Coils, Cores and Magnets" by H. W. Schendel (October and November RADIO-CRAFT). I found an error on page 42. The decimal point was accidentally omitted in calculating the effective cross-sectional area of metal in the core. (0.80 x 0.75 inch equals 0.6 sq. in.)

Permit me to suggest that you run more articles of the nature of that one.

Materials on peaking transformers, saturable reactors (not swinging reactors) and devices or control circuits for electronic counting, sorting, regulating etc., would be especially welcome.

ROLAND R. RHODES,
Huckensack, N. J.

(An article by Jordan McQuay on electronic counting and sorting circuits will appear in an early issue.—Editor)

THREE DIMENSIONS ON PAPER

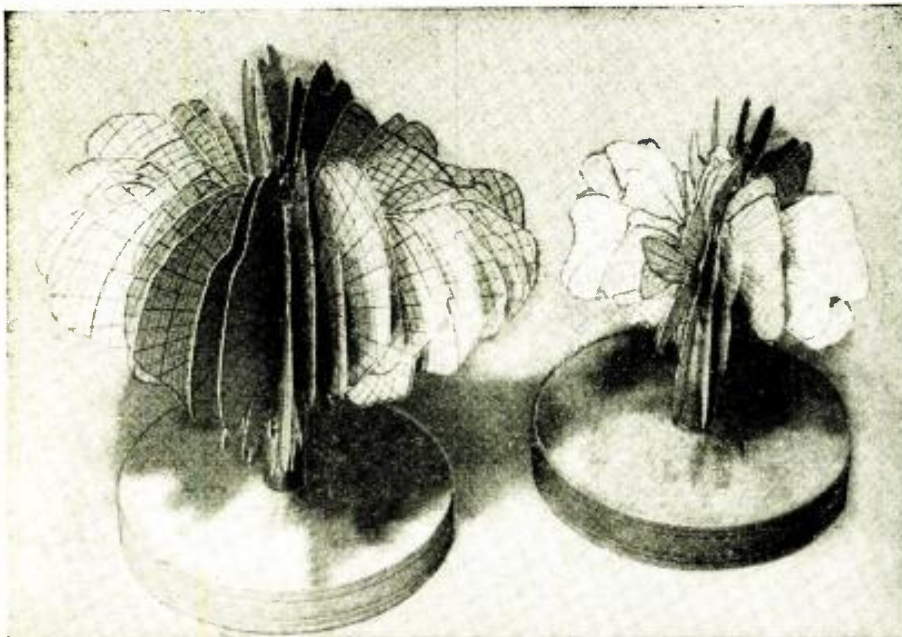

Ohio State University has solved the problem of designing non-confusing models of antenna field patterns by using a series of 2-dimensional cardboard figures. Each represents the vertical field pattern in a given direction. Energy radiated in each direction is indicated by the radial distance from the center of the cluster to the edge of the pattern elements.

RADIO-CRAFT for JULY, 1947

NO SURPLUS REGRETS

When you buy from

Mission Radio Inc.

We stock the products of leading manufacturers of radio parts for immediate delivery.

AVAILABLE NOW

SYLVANIA

Test Equipment

Model # 139 Illustrated
\$79.50 NET



Portable Model # 140—\$79.50 net



OSCILLOSCOPE
3" scope Model # 131
Gray crackle finish. NET **\$78.50**

POLYMER V.T.V.M.
Model # 134 for R.F. to 300 m.c. NET **\$69.50**

All orders shipped within 4 hours of receipt. 20% deposit required on all mail orders.

MISSION RADIO INC.
816 S. Presa Street San Antonio, Texas

**RADIO PARTS
SOUND SYSTEMS
ELECTRONIC APPARATUS**

**Depend on
RADOLEK**

Radolek's big Free Profit Guide Catalog and Profit Bulletin supplements keep you abreast of the rapidly changing radio situation. Buying from Radolek means greater values, better service and more profits. Make Radolek your buying headquarters.



RADIO PARTS

SOUND SYSTEMS

FREE CATALOG

**Large Stocks
Fast Service**



SEND TODAY!

RADOLEK CO., Dept. C-137
601 W. Randolph St., Chicago 6, Ill.
Please send your FREE Profit Guide Catalog.

Name

Address

SAVE AT RADOLEK

EXPERIMENTERS "RECEIVER ALIGNMENT WITHOUT INSTRUMENTS"
SERVICEMEN SIGNAL GENERATOR DIAGRAM; All Bands. Two Tubes, 110 volts. RF & AF output; costs \$5. 100 DIALS. NAMEPLATES (Platinum Paper). Each Item 25c; Three for 50c.

ELECTRONIC PUBLICATIONS Pasadena 4, Calif.

GOVERNMENT SURPLUS

We have on hand a large selection of Radio and Electronic Equipment purchased from the United States Government, and solicit your inquiry on practically any equipment or component parts used by the Army or Navy. Listed below are only a few of the many items we now have in stock.

Jeweled lamp assembly, 1" panel mount, Drake type.....	12 for	\$3.20
Message Holder, excellent for station logs, regular letter size 8 1/2 x 11" with extra clip for holding spare sheets, also protective cover. Reg. Signal Corps Type95	
Spark plug suppressors.....	.6 for	.35
	Box of 50	2.25
Electrolytics, 10 x 10 x 10 x 10 @ 400 V Mallory FP—can89
Dynamotors, for BC 191, BC 375 transmitters. 14 V DC input to 1000 V DC output @ 350 MA, GE-1D-77.....		9.75
Neon Bulbs, GE 1/4 W 115 V Bayonet base	Box of 10	1.20
Neon Bulbs, GE 1/4 W 115 V Candelabra base	Box of 10	1.20
Test clip, Frankel. Insulation piercing type	12 for	.59
RG8/U Coax. 52 Ohm	Per Foot	.08
50' and over	Per Foot	.07
Fiberglass tape, 1" x .015". Excellent insulation	36 Yd. Roll	.35
Empire cloth, .015" thick, Westinghouse tuppennell	Sq. Yd.	.65
Indicator 1-221A. Uses Selayn with indicating rose, 100 TH power tube, assorted breakers, high voltage condensers, etc. Good for antenna & transmitter control and remote modulator basic kit. 100 V 60 cycle		27.50
Scope, 5" 110 V 60 cycle input. Control unit BC-1266—with 5CP1		40.00
If purchased together, both of the preceding items, packed in original shipping case and crate, shipping wgt. 400 #		59.50
A SAVING OF \$8.00		
Kit of 100 1/2 Watt Resistors.....		2.49
Relay, 24 Volt, 60 Cycle Coil. Contacts 15 Amp DPST, Normally Open. Ward Leonard		1.95
Terminal strips. Molded bakelite 16 screw terminals 8 circuits. 5 3/4" long x 2" wide. Barriers between terminals. Mfg. GE.....		.12 each
Lots of 2019 each
Apiece		
45 V Heavy Duty "B" Batteries, 8 x 4 1/4 x 7 1/2.....		1.98
Carton of 435 each
Lots of 100		
Date of manufacture—May, 194598
6 V Lantern Battery, 2 3/4 x 2 3/4 x 8 3/8.....		.15 each
Box of 5		
Lots of 10035
Date of manufacture—June 194525 each
Penlight cells. Box of 12		
Lots of 12 dozen		
Date of manufacture—December 1943		

Above Prices F.O.B. Baltimore
Minimum Order \$2.00

The Abell Distributing Company
5 E. Biddle St. Baltimore 2, Md.

Send for Our Flyers
Name Items Interested In

Headset Headquarters



CANNON-BALL

is unusually sensitive. For clarity of tone, dependable performance, quality at a fair price, choose the Cannon-Ball Guaranteed Headset you like best. Folder R-7 illustrates complete Cannon-Ball line of efficient Headsets. Write

Scientifically Built
Heavy bar magnets greatly increase their efficiency.

C. F. CANNON COMPANY
SPRINGWATER, N. Y.

INDEX TO ADVERTISERS

Abell Distributing Company	78	P. R. Mallory & Company, Inc.	Back Cover
Brodk Advertising Agency		Aitken-Kynett Company	
Allied Radio Corporation	64	Miles Reproducer Company, Inc.	75
George Brodsky Corporation		Altomari Advertising Agency	
American Television, Inc.	Inside Back Cover	Mission Radio, Inc.	77
Turner Advertising Agency		Murray Hill Books Company	47, 66
Amplifier Corporation of America	65	Harry P. Bridge Advertising	
Sternfield-Godley		National Plans Institute	69
Walter Ashe Radio Company	65	National Radio Institute	1
Ralph W. Smith Advertising Agency		Van Sant, Dugdale & Co.	
Audel Publishers	79	National Schools	11
Grant & Wadsworth, Inc.		The Mayers Company	
Beacon Television, Inc.	73	Newark Electric Company, Inc.	61
Frederick-Clinton Co.		Bergman-Jarrett	
Bell Telephone Labs.	16	Newcomb Audio Products Company	59
N. W. Ayer & Son		Stevens Hall Advertising	
Belltone Radio & Television Corp.	8	Niagara Radio Supply	75
Edwin Freed Advertising		Burke and Wayburn Advertising Co.	
Bradshaw Instruments Co.	76	Ohmite Manufacturing Company	48
W. H. Brady Company	74	The Fensholt Company	
Brady-Parkinson Company		Olson Radio Warehouse	55
Brooks Radio Distributing Company	73	Jessop Advertising Company	
Equity Advertising Agency		Opportunity Adlets	56
Buffalo Radio Supply	43	Precision Apparatus Company	72
International Advertising Agency		Shappe-Wilkes, Inc.	
Burstein-Applebee Company	71	Progressive Electronics Company	70
Frank E. Whalen Advertising Company		Thomson, Sawa & Valenti, Inc.	
Buyers' Syndicate	73		
C. F. Cannon Co.	78		
M. J. Werner Advertising			
Capitol Radio Engineering Institute	13		
Henry J. Kaufman & Associates			
Chief Electronics	78		
The Graphic Company of Advertising			
Cleveland Institute of Radio Electronics	41		
Kenneth Kolpein Advertising			
Coastal Radio Service, Inc.	78		
Commercial Radio	73		
The Goulston Company			
Communications Equipment Co.	15		
Borough Advertising Agency			
Concord Radio Corporation	45		
E. H. Brown Advertising Agency			
Cornell-Dublier Electric Corporation	3		
Reiss Advertising			
Coyne Electrical School	74		
Gordon Best Company, Inc.			
Coyne Electrical School	71		
Phil Gordon Advertising Agency			
DeBaugh Company	71		
Daer & Taylor	75		
Spencer W. Curtiss Advertising			
DeForest's Training Institute	9		
Lauesen & Salomon			
Eastern Electronics Company	61		
Eaton's	74		
Electronic Publications	77		
Esse Radio Company	12		
Gary A. Ruben Advertising			
General Cement Mfg. Company	73		
Sander Rodkin Advertising Agency			
General Electronic Distributing Company	49		
Bass & Weber Company, Inc.			
General Test Equipment Company	65		
Suzanne Hayman Advertising			
Globe Distributors	58		
The Goulston Company			
Hallcrafters Company	Inside Front Cover		
Burton Browne, Inc.			
Herbach & Rademan, Inc.	72		
Philip Klein Advertising Agency			
Hershel Radio Company	14		
Hugh Allen Company			
Highbridge Radio-Television & Appliance Co.	52		
Burke & Wayburn Advertising Agency			
Hudson Specialties	70		
Instructograph Company	70		
Turner Advertising Agency			
J-M-P Manufacturing Company	72		
Katolight Company	71		
Lafayette Radio	54		
Reiss Advertising Agency			
Lake Radio Sales Company	73		
Sander Rodkin Advertising Agency			
Leeds Radio Company	60		
Weber Associates			
Leotone Radio Corporation	68		
Altomari Advertising Agency			
Lifetime Sound Equipment Company	76		
The Miller Agency Company			
McMurdo Silver Company	6		
Edward Owen & Company			

RADIO SCHOOL DIRECTORY

(See Page 80)

American Radio Institute	
Sternfield-Godley Inc.	
Baltimore Technical Institute	
Candler System Company	
Rand-Ries Advertising	
Commercial Radio Institute	
Don Martin School of Radio Arts	
Hollywood Sound Institute	
Nelson Advertising Service	
Lincoln Engineering School	
Buchanan-Thomas Advertising	
Melville Radio Institute	
Seidell Advertising	
Milwaukee School of Engineering	
Klau-Van Pietersooq-Dunlap Associates	
RCA Institutes	
Tri-State College	
Clem J. Steigmeyer Advertising	
Radio Center	57
Claude E. Whipple Advertising	
Rodcraft Publications	62
Radio Kits	76
Hamburger Agency	
Radio Publications	59
Radio Supply and Engineering Company	4
Karl G. Behr Advertising Agency	
Radioic Equipment Company	53, 58, 70, 72, 75
Republic Advertising Agency	
Radolek Company	77
Turner Company	
Reed Manufacturing Company	65
Borg Advertising Agency	
Howard W. Sams and Company, Inc.	5
Aitken-Kynett Company	
Sprayberry Academy of Radio	7
Harry P. Bridge Company	
Sterling Electronic Company	72
Superior Instruments Co.	63
Bass & Weber Advertising	
Supreme Instruments Corporation	69
O'Callaghan Advertising Agency	
Supreme Publications	51
Henry H. Teplitz Advertising	
Sylvania Electric Products, Inc.	2
Newell-Emmett Company	
"TAB" Technical Apparatus Bldrs.	67
Weber Associates	
Teletronics	56
Burke and Wayburn Advertising Agency	
Tel-Rad Electronics Co.	69
Turner Company	44
W. D. Lyon Company	
United Radio and Sound Amplification	70
May Advertising Company	
Wright, Incorporated	71
Kay Advertising, Inc.	
X. L. Radio Laboratories	69

SERVICE MEN!

- RCA Radiotron
- Tungsol
- Raytheon
- Sylvania
- New Astatic
- QT-J
- Nylon Crystals

\$5.24 each

Write for our latest bulletin, Dept. C2

Distributors of RADIO EQUIPMENT

CHIEF ELECTRONICS

104 MAIN STREET, POUGHKEEPSIE, N. Y.

The Square Deal Supply House

SPEAKERS REBUILT CONES—FIELDS—ALL STYLES DISTRIBUTORS

Prices are right—Quality good

Coastal Radio Service, Inc.

1559 Stratford Ave., Bridgeport 7, Conn.

Television for the middle-sized community is possible, say Sarkes and Mary Tarzian, who May 8 were granted a construction permit for a television station at Bloomington, Indiana. To insure

a large audience, Mr. Tarzian has announced that he will manufacture several thousand television receivers and sell them "at the lowest possible figure" to persons within range of the station.

BOOK REVIEWS

APPLIED PRACTICAL RADIO, by the Technical Staff, Coyne Electrical and Radio School. Published by Coyne Electrical School. Three volumes, 306, 299 and 403 pages, plus volume index in each volume and additional master index in first volume. Stiff cloth covers, 5½ x 8½ inches. Price per set, \$9.75.

This text was written to fit the needs of a resident radio and television course, at the same time keeping in mind the person who wishes to increase his knowledge of radio but has not the time or money for a resident or correspondence course.

The first volume deals with elementary electrical theory. An effort has been made to approach the subject from a fresh viewpoint. A number of new analogies and illustrations appear, and where old ones are used, they are dressed up with new types of drawings which add to the interest.

The second book covers applied radio theory, beginning with alternating currents in radio, and continuing through resonance and tuning, r.f. coils and radio tubes to r.f. coupling and coupling circuits. The third volume is devoted to radio receivers, including chapters on antennas, amplifiers and loudspeakers, receiver controls, and receiver alignment.

Superheterodyne receivers, automobile radios, public address systems and shortwave reception receive a chapter apiece, while two chapters each are devoted to FM and FM receivers and to television and television receivers. A large number of breakdown drawings are used to explain the text.

ELEMENTARY RADIO SERVICING, by William R. Wellman, chairman, radio department, Brooklyn High School for Specialty Trades. Published by D. Van Nostrand Co. Stiff cloth covers, 6½ x 9 inches, 260 pages. Price \$3.00.

Writing for the man who has gained some knowledge of radio construction or has had vocational-school or wartime training, the author seeks to show how such knowledge may be applied to radio servicing.

The first chapter deals with the use of test equipment, then there are chapters on each section of standard receivers, on miscellaneous troubles and on alignment. Automobile radios, portables

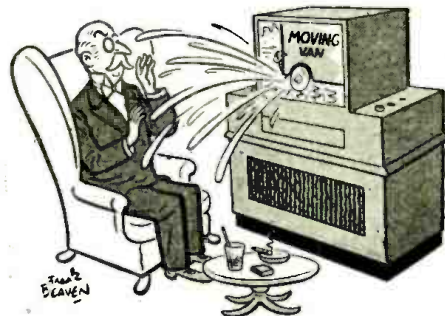

Suggested by Grego Banskuck

and FM receivers are given special treatment.

Job sheets and experiments are included with almost every chapter. These, together with lists of questions and references, fit the book for use as a text in an elementary service course as well as for independent study.

No radio theory or mathematics are included. The approach is purely practical, presupposing a knowledge of elementary radio theory and familiarity with schematics.

ELECTRONIC CAPACITORS, by Paul McKnight Deeley. Published by the Cornell-Dubilier Electric Corporation. Stiff cloth covers, 5½ x 8 inches, 276 pages. Price \$3.00.

Written by a practical engineer, this book is much more "down-to-earth" than earlier works on the subject. Description of the fabrication of capacitors and the forming of anodic films is unusually thorough and complete.

In some directions, the author has been limited by the fact that various manufacturers have processes that may be termed trade secrets. While disclosure of such processes has been studiously avoided, the general subject has been covered completely. The "leaning over backwards" attitude shown in some books, which avoid printing even formulas for electrolytes, is absent.

The presentation is clear. According to the slip cover, the intention was to write "in simple language readily understood by students, repair and maintenance men and highly trained engineers alike," and that object was attained.

THE ELECTRONIC CONTROL HANDBOOK, by Ralph R. Batchler and William Moulic. Published by Caldwell-Clements, Inc. Flexible leatherette covers, 6 by 9¼ inches, 344 pages (including a 3-page bibliography and an index). Price \$4.50.

This well-written work, with its large number of charts, diagrams and photographs, is presented in such a manner that it can truthfully be called a "handbook." It is a useful compilation of twenty-one chapters of essential data on electronic control systems and their possible applications in industry.

Its chapters are grouped into five sections according to the type of material under discussion. The presentation is such that all material can be readily understood by students, engineers and maintenance men with a basic knowledge of electronic principles.

The five sections; Basic Elements of Control, Conversion Elements, Electronic Modification Circuits, Activation Elements and Control Motors present, in a useful light, discussions of methods of converting pneumatic, hydraulic, mechanical, electrical and other physical changes into electronic voltage or current variations to actuate control mechanisms.—R.F.S.

7 DAYS FREE EXAMINATION

Just Out!

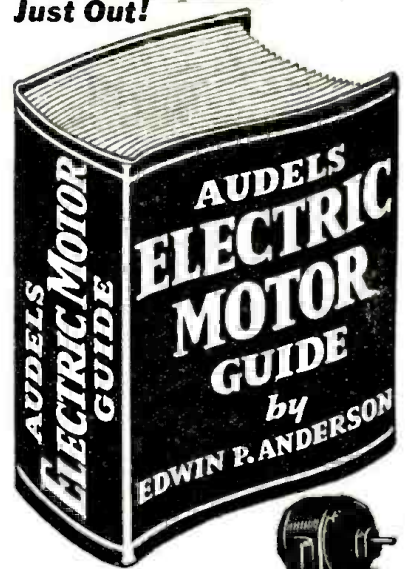

1000 PAGES OF PRACTICAL MOTOR INFORMATION

AUDELS ELECTRIC MOTOR GUIDE covering the construction, hook-ups, control, maintenance and trouble shooting of all types of motors including armature winding. Explains entire subject in every detail. 31 Chapters, 617 Illustrations & Diagrams. A Handy Guide, Fully Indexed for Electricians and all Electrical Workers.

\$4 COMPLETE • PAY ONLY \$1 A MONTH
Step up your own skill with the facts and figures of your trade. Audels Mechanics Guides contain Practical Inside Trade Information in a handy form. Fully illustrated and easy to understand. Highly Endorsed. Check the book you want for 7 days Free Examination.

Send No Money. Nothing to pay postman.

CUT HERE MAIL ORDER

AUDELS, Publishers, 49 W. 23 St., NEW YORK 10, N. Y.

Please send me postpaid for FREE EXAMINATION books marked (x) below. If I decide to keep them I agree to mail \$1 in 7 Days on each book ordered and further mail \$1 monthly on each book until I have paid price. Otherwise, I will return them.

- ELECTRIC MOTOR GUIDE, 1000 Pages . . . \$4.
- ELECTRICIANS EXAMINATIONS, 250 Pages . . . 1.
- WIRING DIAGRAMS, 210 Pages . . . 1.
- ELECTRICAL DICTIONARY, 9000 Terms . . . 2.
- ELECTRICAL POWER CALCULATIONS, 425 Pgs. . . 2.
- ELECTRONIC DEVICES, 216 Pages . . . 2.
- RADIOMANS GUIDE, 914 Pages . . . 4.
- HANDY BOOK OF ELECTRICITY, 1340 Pages . . . 4.
- ELECTRIC LIBRARY, 12 vol., 7000 Pgs., \$1.50 vol. . . 1.
- OIL BURNER GUIDE, 384 Pages . . . 1.
- REFRIGERATION & Air Conditioning, 1280 Pgs. . . 4.
- POWER PLANT ENGINEERS GUIDE, 1500 Pages . . . 4.
- PUMPS, Hydraulics & Air Compressors, 1658 Pgs. . . 4.
- AUTOMOBILE GUIDE, 1540 Pages . . . 4.
- DIESEL ENGINE MANUAL, 400 Pages . . . 2.
- WELDERS GUIDE, 400 Pages . . . 1.
- BLUE PRINT READING, 416 Pages . . . 2.
- SHEET METAL WORKERS Handy Book, 388 Pgs. . . 1.
- SHEET METAL PATTERN LAYOUTS, 1100 Pgs. . . 4.
- AIRCRAFT WORKER, 240 Pages . . . 1.
- MATHEMATICS & CALCULATIONS, 700 Pgs. . . 2.
- MACHINISTS Handy Book, 1600 Pages . . . 4.
- MECHANICAL Dictionary, 968 Pages . . . 4.
- MARINE ENGINEERS Handy Book, 1280 Pages . . . 4.
- MECHANICAL DRAWING GUIDE, 160 Pages . . . 1.
- MECHANICAL DRAWING & DESIGN, 480 Pgs. . . 2.
- MILLWRIGHTS & Mechanics Guide, 1200 Pgs. . . 4.
- CARPENTERS & Builders Guides (4 vols.) . . . 6.
- PLUMBERS & Steamfitters Guides (4 vols.) . . . 6.
- MASONS & Builders Guides (4 vols.) . . . 6.
- MASTER PAINTER & DECORATOR, 320 Pgs. . . 2.
- GARDENERS & GROWERS GUIDES (4 vols.) . . . 6.
- ENGINEERS and Mechanics Guides . . . 1.
- Nos. 1, 2, 3, 4, 5, 6, 7 and 8 complete . . . 12.
- Answers on Practical ENGINEERING . . . 1.
- ENGINEERS & FIREMANS EXAMINATIONS . . . 1.

Name _____
Address _____
Occupation _____
Employed by _____ RCF

RADIO SCHOOL DIRECTORY

PREPARE NOW FOR SKILLED JOBS IN RADIO AND ELECTRONICS

CAREERS in RADIO

INTENSIVE COURSES—Thorough, technical education for progressive men and women.

Licensed by the State of New York

1. **RADIO TECHNICIAN**—The MRI General Course. Includes F.M. & Television. Prepares For FCC Broadcast Licenses.
2. **RADIO & TELEVISION SERVICING**—Prepares for employment as Repairman on Standard Broadcast, F.M. & Television Receivers.
3. **RADIO COMMUNICATIONS**—Prepares for FCC Operators' License. Leads to position as Merchant Marine or Flight Radio Officer; Commercial Operator.
4. **FUNDAMENTAL RADIO MATHEMATICS**—The MRI Preparatory Course. Required pre-training for students lacking a basic mathematical background.

MELVILLE RADIO INSTITUTE
45 W. 45th St., N. Y. 19, BR 9-5080

"The Radio School Managed By Radio Men"

MELVILLE RADIO INSTITUTE

45 West 45th St., New York 19, N. Y.

GENTLEMEN: RC

Send me FREE information about your school.

Name.....

Address.....

MAIL THIS COUPON NOW

Radio Thirty-Five Years Ago

In Gernsback Publications

HUGO GERNSBACK

Founder

Modern Electrics	1906
Electrical Experimenter	1913
Radio News	1919
Science & Invention	1920
Radio-Craft	1929
Short-Wave Craft	1930
Wireless Association of America	1908

Some of the larger libraries in the country still have copies of **ELECTRICAL EXPERIMENTER** on file for interested readers.

From July, 1913, **ELECTRICAL EXPERIMENTER**:

How to Select and Operate Wireless Telegraph Sets, by *H. Winfield Secor*.

How to make Selenium Cells, by *Samuel Wein*.

A Handy Vacation Wireless Set, by *Henry Scott*.

Horizontal Antenna

New Wireless Instruments, by *H. Gernsback*.

New Ear Telephone

SIGNAL GENERATOR

(Continued from page 56)

tenna post of the receiver. The tuning condensers of both units are fully meshed. The receiver is tuned slowly across the band and the frequencies where the oscillator signal is heard are noted. The frequency difference between any two points on the receiver dial is equal to the oscillator frequency. This frequency is marked on the oscillator dial. The oscillator is shifted slightly and new repeat points noted.

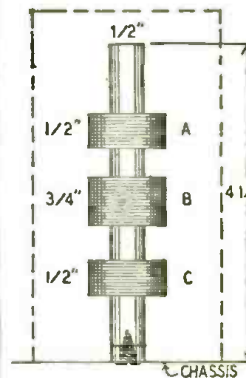

Fig. 2—Coil details.

This process is continued until band A is completely calibrated. The same method is used to calibrate band B. Band C is calibrated by reading the frequency directly from the dial of the receiver.—*Les Jones*

LEARN NOW!

ELECTRONICS

- RADIO
- F.M. and TELEVISION
- PUBLIC ADDRESS SYSTEMS
- SHORT WAVE COMMUNICATIONS

Men! Women! Find successful careers in this fascinating field! Ample equipment for all to use in **practical** classes. You start practice when you enroll!

Approved for Veterans

HOLLYWOOD SOUND INSTITUTE

1040 N. Kenmore Ave., Dept. B
LOS ANGELES 27, CAL.

LEARN

RADIO

Get F.C.C. License
RADIO — TELEVISION
Repairing

Classes start every month

Our organization engaged in **TECHNICAL TRAINING** for 27 Years
LITERATURE ON REQUEST

BALTIMORE TECHNICAL INSTITUTE
1425 Eutaw Place. Balto. 17, Md.

COMMERCIAL RADIO INSTITUTE

A radio training center for twenty-six years.

RESIDENT COURSES ONLY

Broadcast, Service, Aeronautical, Television and Marine telegraphy classes; Preparatory Course now forming. Literature upon request. Veteran training. Classes now forming for July 1st. Entrance examination June 18.

Dept. C. 38 West Biddle St., Baltimore 1, Md.

SOUND RECORDING SCHOOL

A practical 9 months' course in Sound Fundamentals, Recordings, and Sound Transmission measurements; in a laboratory containing transmission sets, oscillators, square wave generator and intermodulation analyzer, and other equipment.

Two complete recording studios assimilating broadcast, motion picture and commercial sound recording, under the direction of H. M. Tremaine.

Approved for Veterans
DON MARTIN SCHOOL OF RADIO ARTS
1655 Cherokee St., Hollywood, Calif.

PRACTICAL TECHNICAL TRAINING FOR YOU

Specialize in Electronics, Radio, Electricity, Refrigeration, Heating and Air Conditioning, or Welding. Prepare in one year for position as Technician, or in two additional years secure your B. S. Degree in **ELECTRICAL ENGINEERING** with major in Machinery or Electronics.

Write for booklet "Career Building"

MILWAUKEE SCHOOL of ENGINEERING

INSTITUTE OF ELECTRONICS
RC-747 N. Broadway and E. State, Milwaukee, Wis.

CODE SENDING SPEED RECEIVING SPEED

Be a "key" man. Learn how to send and receive messages in code by telegraph and radio. Commerce needs thousands of men for jobs. Good pay, adventure, interesting work. Learn at home quickly through famous Candler System. Write for FREE BOOK.
CANDLER SYSTEM CO.
Dept. 3-M Box 928, Denver 1, Colo., U.S.A.

CORRESPONDENCE COURSES IN RADIO and ELECTRICAL ENGINEERING

ELECTRICAL ENGINEERING Get good grasp of wide electrical field. Prepare yourself at Low Cost, for secure future. Modern course. So simplified anyone can understand quickly.

RADIO ENGINEERING Extra fine course in radio. public address, photo-electric work. Trains you to be super-service man, real vacuum tube technician. Servicemen needed badly. Diploma on completion. Many graduates earning big pay.

Send postcard for Free Copies of school catalog. Full details, all about deferred payment plan, experimental kits, etc. **\$25** Course
WRITE Lincoln Engineering School, Box 931C-101, Lincoln 2, Nebr.

RADIO

TECHNICIAN and RADIO SERVICE COURSES
FM and TELEVISION

AMERICAN RADIO INSTITUTE

101 West 63rd St., New York 23, New York

Approved Under GI Bill of Rights

Licensed by New York State

RADIO ENGINEERING!

Complete Radio Engineering Course. Bachelor of Science Degree. Courses also in Civil, Electrical, Mechanical, Chemical, Aeronautical Engineering; Business Administration, Accounting, Secretarial Science. 63rd year. Enter June, Sept., Jan., Mar. School now filled to capacity. No applications can be accepted until further notice.

TRI-STATE COLLEGE 2458 College Ave. ANGOLA INDIANA



RCA INSTITUTES, Inc.

Offer thorough training courses in all technical phases of

Radio and Television

DAYS—EVENINGS WEEKLY RATES

VETERANS: RCA Institutes is approved under G. I. Bill of Rights

For Free Catalog Write Dept. RC-47

RCA INSTITUTES, Inc.

A Service of Radio Corporation of America
76 VARICK STREET NEW YORK 13, N. Y.

TELEVISION-

America's Next Giant Industry?



Billboard Announcing Telecasts of Ball Games in Chicago



U. A. Sanabria

Dr. Lee deForest

The Men Who Direct American Television

The instructional quality of training is under the constant personal supervision of two internationally known engineers, Mr. U. A. Sanabria, President and Founder of American Television, Inc. and Dr. Lee deForest, the famed inventor of the radio tube.



FREE PRE-ENTRANCE COURSE

A Short Home Study Television Course is available to qualified war veterans who are considering residence training. This course is free of any charge or obligation. Your success with it will help you to learn your own abilities in television. It will also aid us greatly in qualifying you for residence training. Your acceptance of the Home Study course in no way obligates you to enter our residence school. So we urge you to take advantage at once of the very unusual opportunity it offers.



Today, RIGHT NOW, clear and bright pictures of great sports events, as well as other equally interesting programs, are being telecast for the enjoyment of thousands. Television stations in New York, Chicago, Philadelphia, Washington, Detroit, St. Louis and Los Angeles are already operating on regular schedules. Construction has started in several other centers and it is believed that practically every major city in the country will have this wonderful service before the end of 1948.

Who will build, maintain, and operate the new telecast stations? Who will design, produce, install and service the receivers?

Men Must Be Trained for These New Professions

Alert young men with an ambition to grow with television are training now in the greatly enlarged instruction laboratories of American Television, Inc. A wide choice of courses available. Advanced methods and latest obtainable equipment used.

One of Our New Buildings.
Air Conditioned the Year Round.



Approved for Veteran Training Under G. I. Bill of Rights

American Television, Inc.

5050 BROADWAY

CHICAGO 40, ILLINOIS

REQUEST FOR FREE INFORMATION

American Television, Inc., Dept. of Information
5050 Broadway, Chicago 40, Illinois

Please send details of your Television Training.

NAME _____

ADDRESS _____

CITY _____

ZONE _____

STATE _____

I am a veteran

57
Four Out of Five Auto Radios Have It*

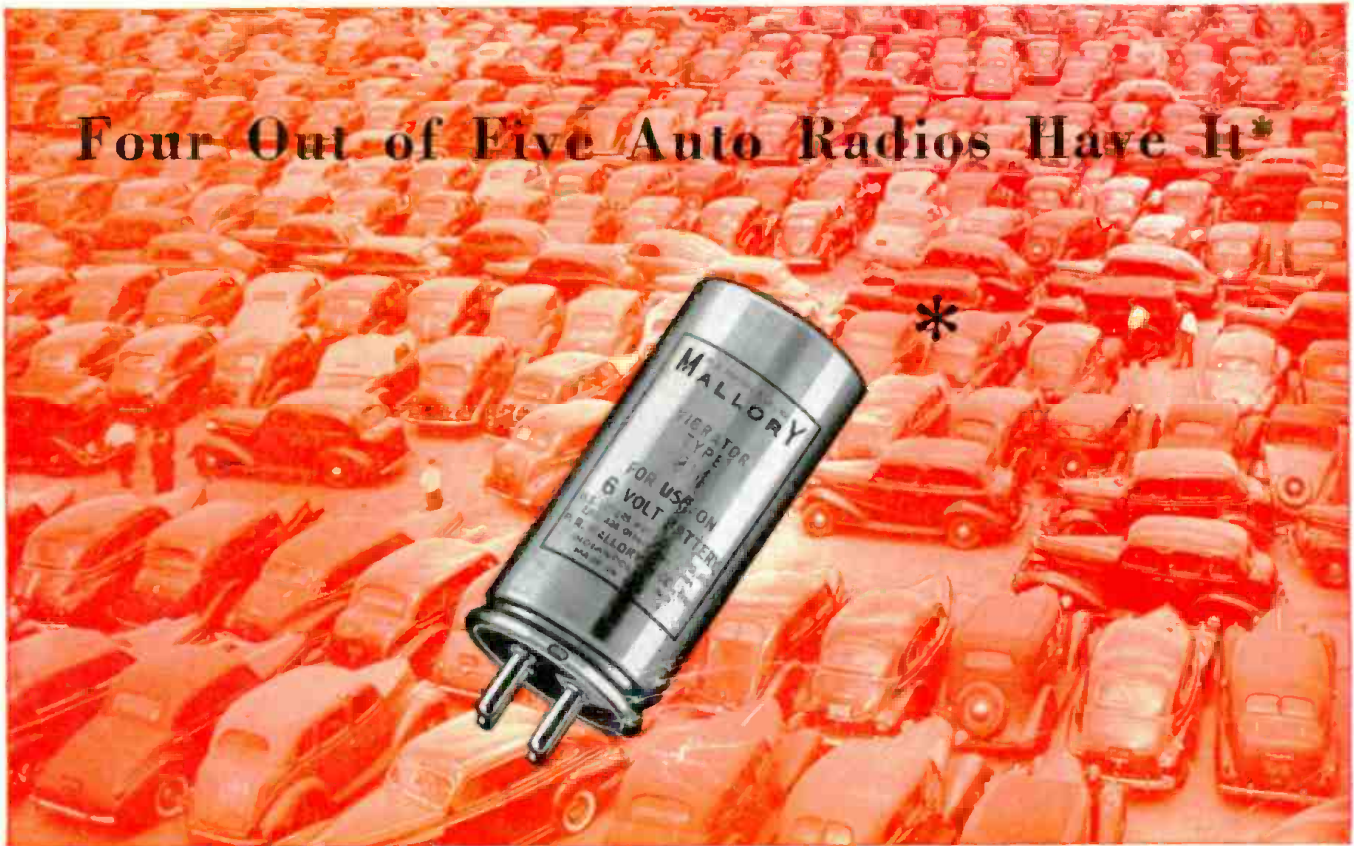

That's Why the Mallory Vibrator Makes the Best Replacement

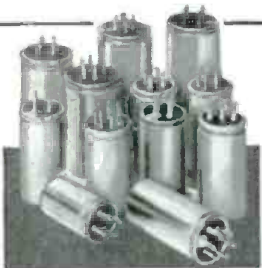

Mallory Has the Most Complete Vibrator Line

The 12 basic vibrators illustrated above answer 90% of your replacement requirements. But Mallory offers 50 vibrators in all so that every need can be instantly met. The Mallory line is the most complete in the business.

More Mallory vibrators are in use today than all other makes combined. In the field of auto radio alone, four sets out of every five carry Mallory vibrators *as original equipment*. Why?

Because Mallory is the world's largest producer of vibrators—has learned the "hard way" how to make vibrators. Because Mallory has introduced many vibrator "firsts" . . . has patented more than 50 improvements . . . adheres to the strictest production standards in the vibrator industry.

These are good and sufficient reasons, too, why Mallory vibrators make *the best replacements*. You can't do better, when you service a set than to use a Mallory replacement.

See Your Mallory Distributor for a free copy of the 1947 Replacement Vibrator Guide

P. R. MALLORY & CO. Inc.
MALLORY

VIBRATORS . . . VIBRAPACKS* . . . CAPACITORS . . . VOLUME CONTROLS . . . SWITCHES . . . RESISTORS . . . FILTERS . . . RECTIFIERS . . . POWER SUPPLIES.

*REG. U. S. Pat. Off.

APPROVED PRECISION PRODUCTS

P. R. MALLORY & CO., Inc., INDIANAPOLIS 6, INDIANA